



US00D603936S

(12) **United States Design Patent**
Hoernig et al.

(10) **Patent No.:** **US D603,936 S**

(45) **Date of Patent:** **** Nov. 10, 2009**

(54) **HANDHELD SHOWER**

D592,276 S * 5/2009 Schoenherr et al. D23/223

* cited by examiner

(75) Inventors: **Victor Hoernig**, Lowell, IN (US);
Geraint Krumpe, Chicago, IL (US);
Chia-Ying Lee, Chicago, IL (US);
Mercedita Andrew, Chicago, IL (US);
Julian Giggs, Hillsdale, MI (US);
Michael Miller, Portage, MI (US)

Primary Examiner—Robin V Webster
(74) *Attorney, Agent, or Firm*—Edgar A. Zarins; Nirav D. Parikh

(57) **CLAIM**

(73) Assignee: **Alsons Corporation**, Hillsdale, MI (US)

The ornamental design for a handheld shower, as shown and described.

(**) Term: **14 Years**

DESCRIPTION

(21) Appl. No.: **29/332,447**

FIG. 1 is a perspective view of a handheld shower showing our new design;

(22) Filed: **Feb. 17, 2009**

FIG. 2 is a top plan view thereof;

(51) **LOC (9) Cl.** **23-01**

FIG. 3 is a bottom plan view thereof;

(52) **U.S. Cl.** **D23/223**

FIG. 4 is a right side view thereof;

(58) **Field of Classification Search** D23/213,
D23/223, 226; 4/615; 239/394, 462
See application file for complete search history.

FIG. 5 is a left side view thereof;

FIG. 6 is a front elevational view thereof; and,

FIG. 7 is a rear view thereof.

(56) **References Cited**

The broken line showing of the front portion of the shower head is included for the purpose of illustrating environment and forms no part of the claimed design.

U.S. PATENT DOCUMENTS

D578,606 S * 10/2008 Wu et al. D23/223

D581,485 S * 11/2008 Kollmann et al. D23/223

1 Claim, 3 Drawing Sheets

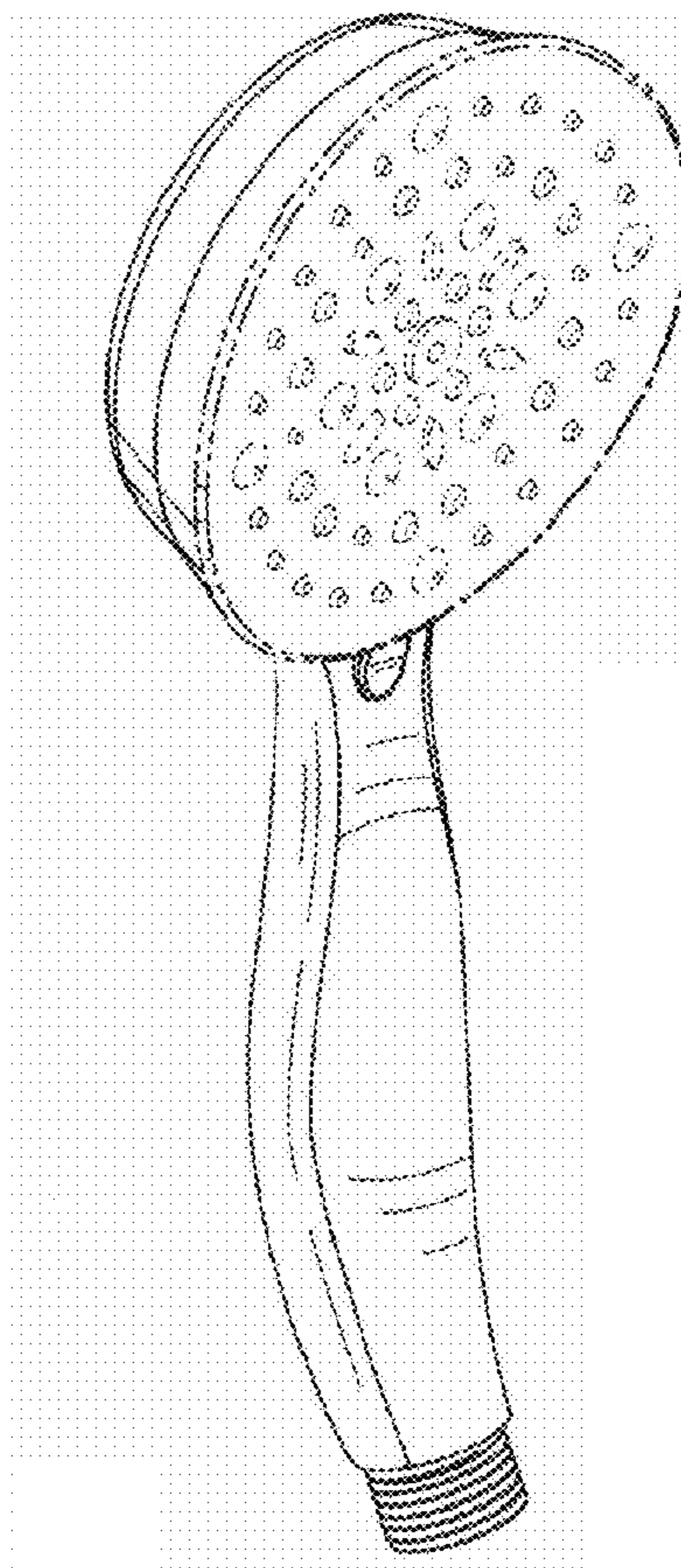

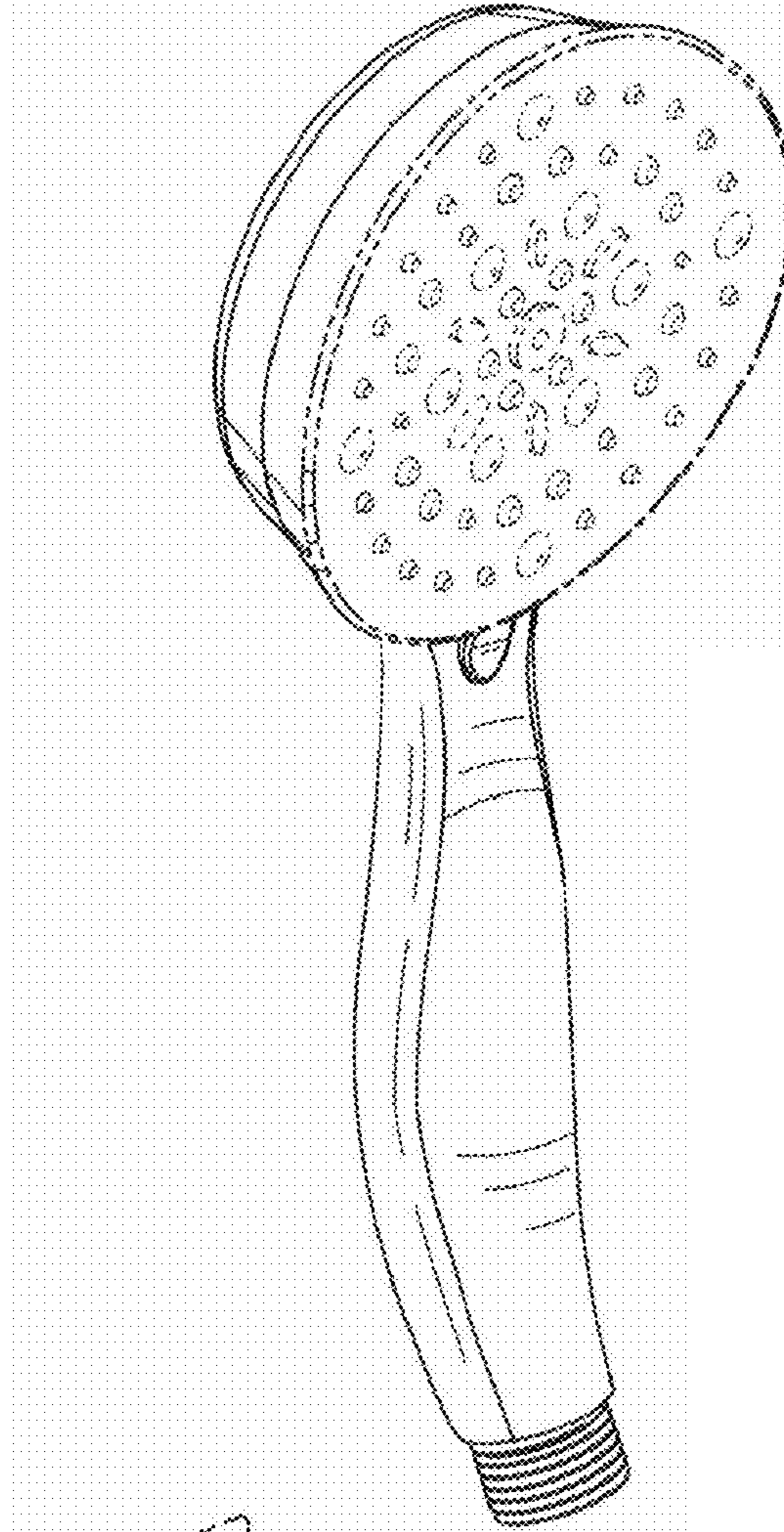

Fig-1

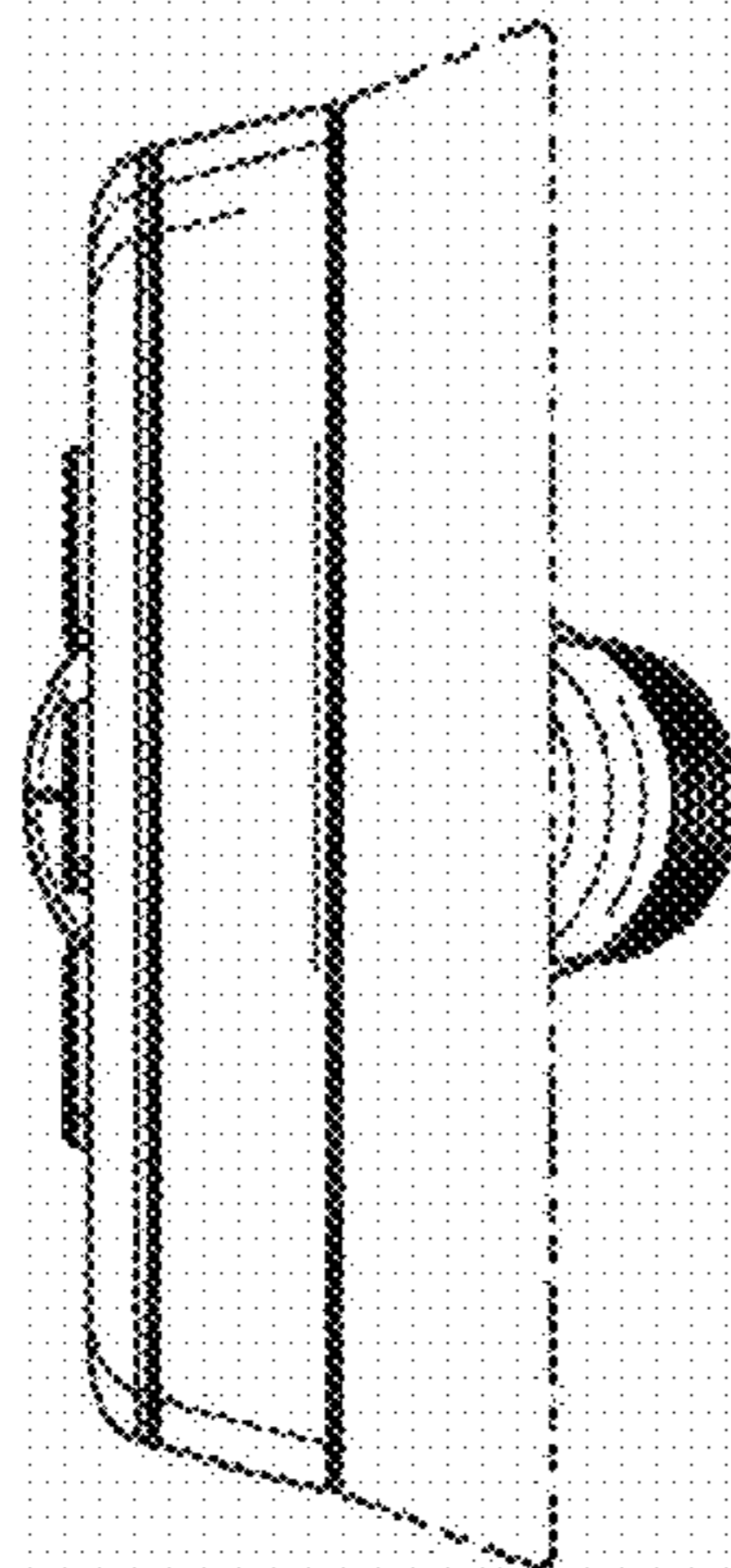

Fig-2

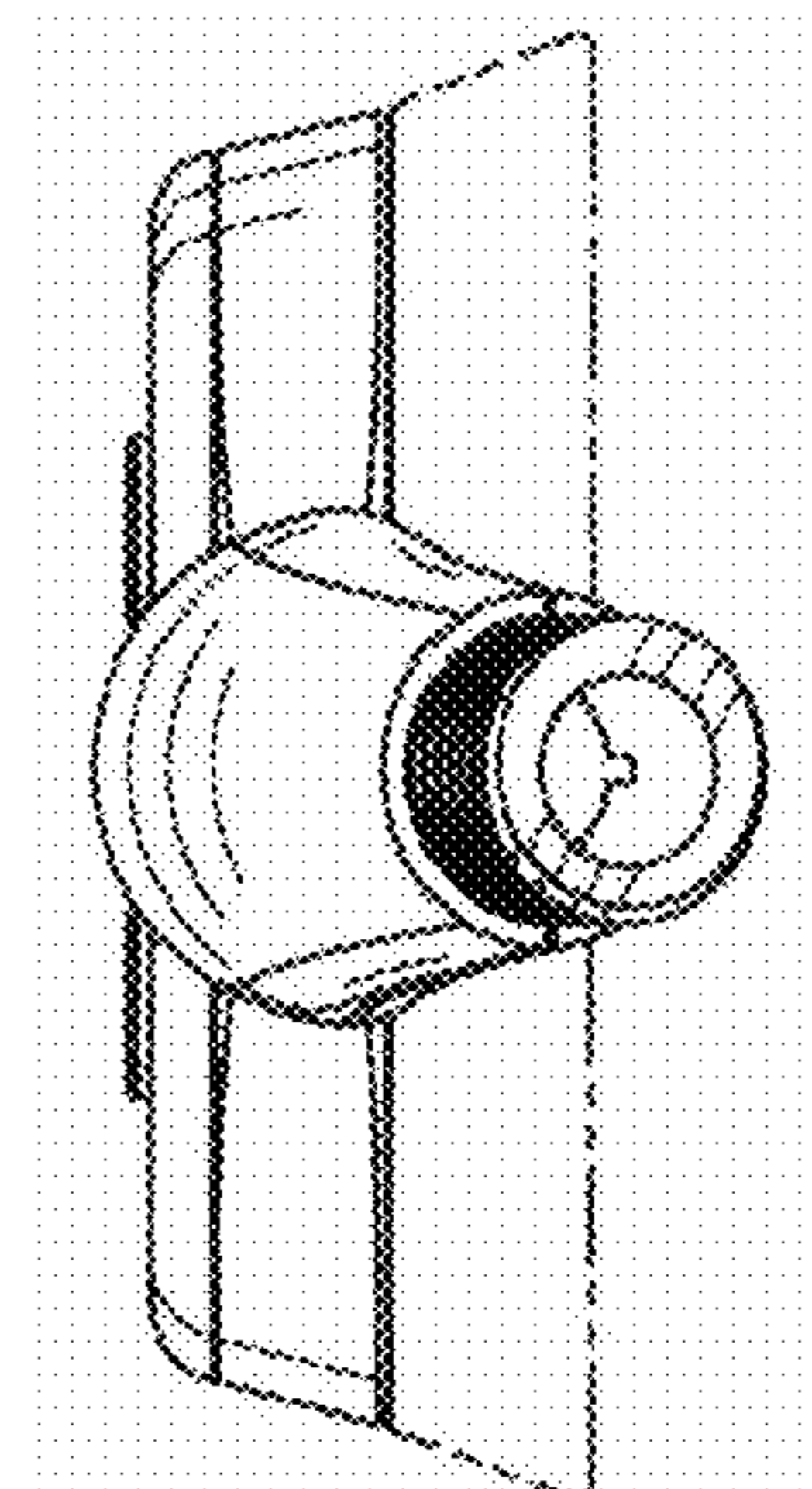

Fig-3

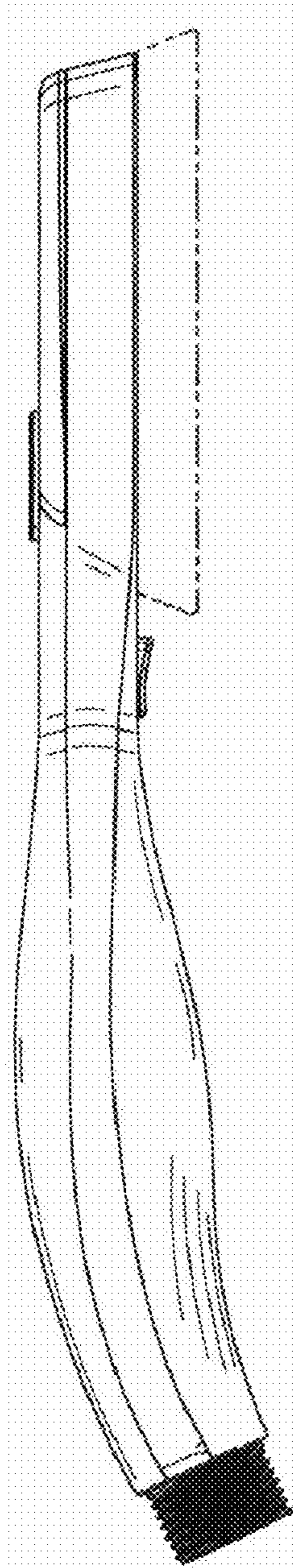

Fig-4

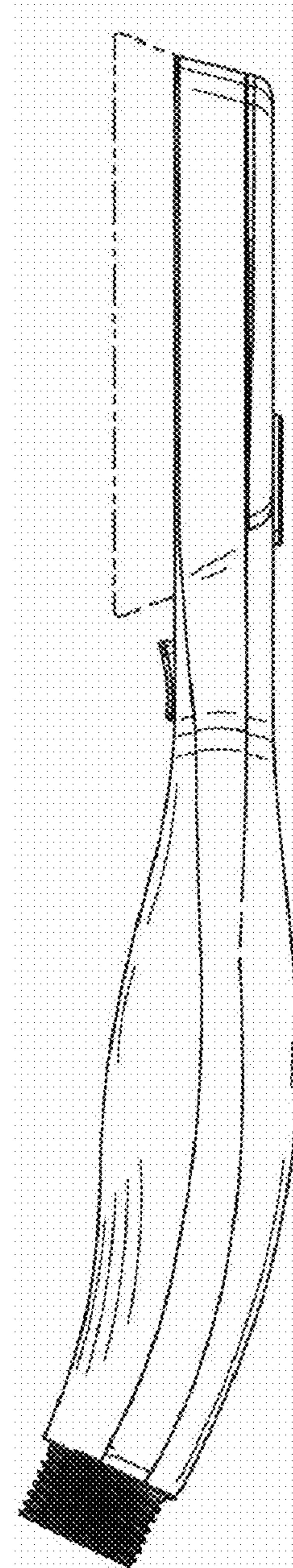

Fig-5

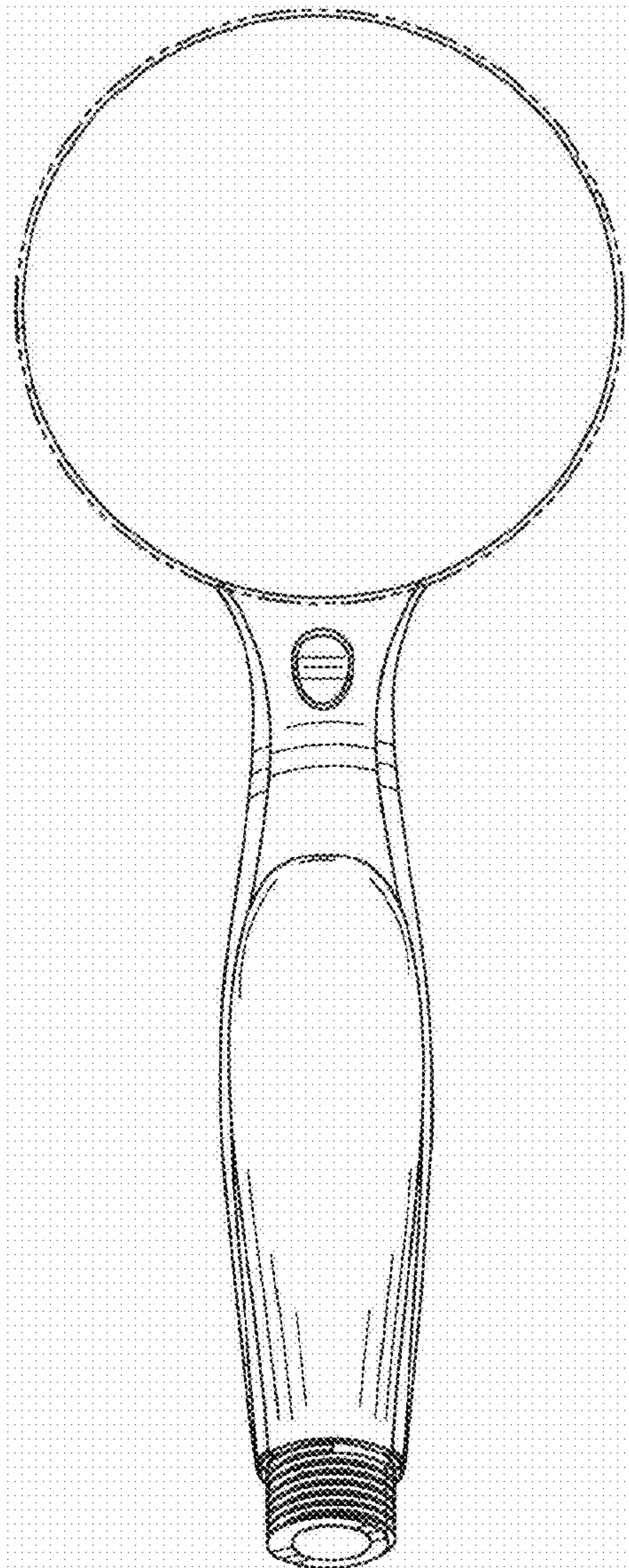

Fig-6

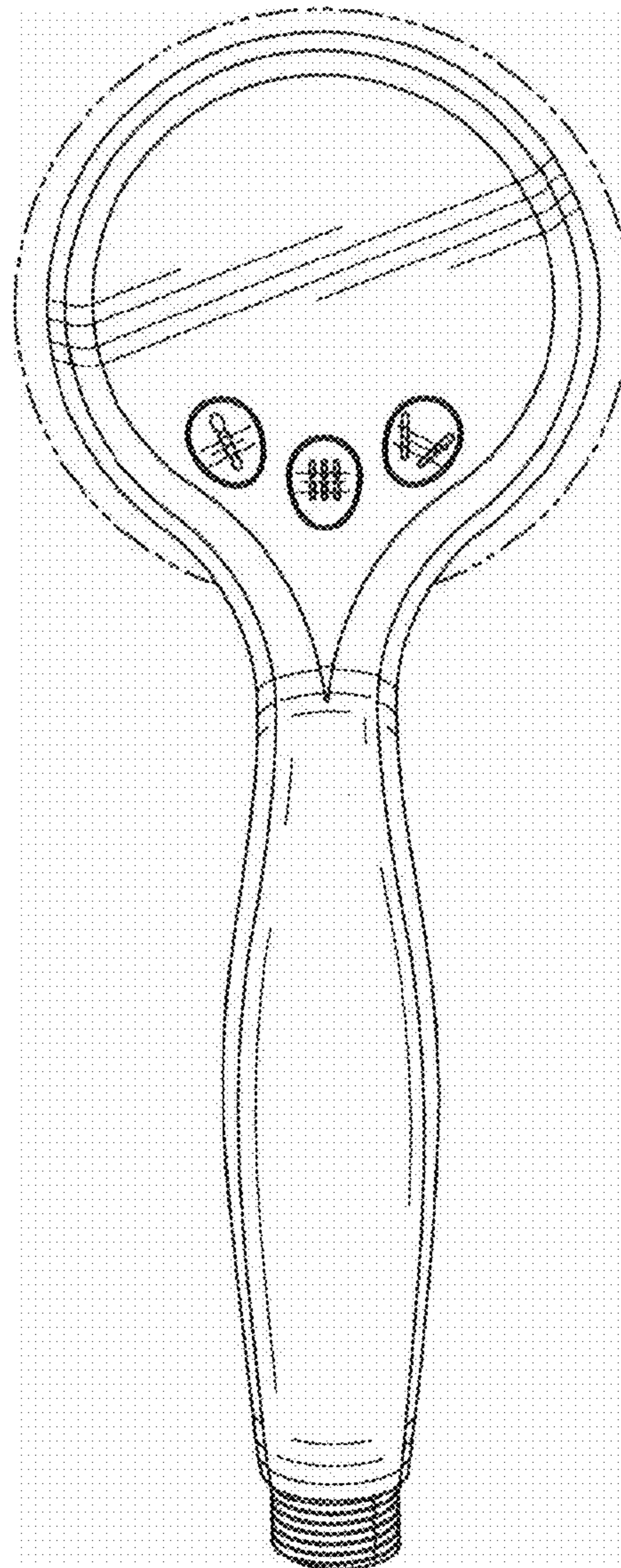

Fig-7