



US00D603925S

(12) **United States Design Patent**
Hafdal

(10) **Patent No.:** **US D603,925 S**

(45) **Date of Patent:** **** Nov. 10, 2009**

(54) **CLIP-ON GOLF BALL CLEANER AND DIVOT REPAIR TOOL**

(76) **Inventor:** **Bill Hafdal**, 555 E. Lake Geneva Rd.
North East, Alexandria, MN (US) 56308

(**) **Term:** **14 Years**

(21) **Appl. No.:** **29/313,303**

(22) **Filed:** **Dec. 24, 2008**

(51) **LOC (9) Cl.** **21-02**

(52) **U.S. Cl.** **D21/793**

(58) **Field of Classification Search** D21/789,
D21/793-794; 473/285, 286, 406, 408
See application file for complete search history.

(56) **References Cited**

U.S. PATENT DOCUMENTS

3,453,675	A	7/1969	Barton et al.	
3,750,219	A	8/1973	MacConnell	
3,981,039	A	9/1976	Rumph	
4,084,287	A	4/1978	Ingram et al.	
4,344,203	A	8/1982	Gerrick	
4,627,621	A *	12/1986	Tate	473/286
4,683,603	A	8/1987	Purlia et al.	
5,305,999	A *	4/1994	Tate	473/406
D348,402	S *	7/1994	McDonald	D10/31
5,788,197	A *	8/1998	Tutela	248/156
5,900,069	A	5/1999	Llerena	
6,022,280	A *	2/2000	Arenburg et al.	473/408
D424,124	S	5/2000	Diaz	
D425,164	S *	5/2000	Tate	D21/793

D432,198	S *	10/2000	Adam	D21/793
6,148,464	A	11/2000	Shioda	
6,550,093	B1	4/2003	Shioda	
6,594,851	B2	7/2003	Sprague	
D493,502	S	7/2004	Shioda	
D522,080	S	5/2006	Shioda	

* cited by examiner

Primary Examiner—Mitchell I Siegel

(74) *Attorney, Agent, or Firm*—Robert C. Montgomery;
Joseph T. Yakisich

(57) **CLAIM**

The ornamental design for a clip-on golf ball cleaner and divot repair tool.

DESCRIPTION

FIG. 1 is an isometric view of a clip-on golf ball cleaner and divot repair tool, as shown and described;

FIG. 2 is an exploded isometric view thereof;

FIG. 3 is an exploded front view thereof;

FIG. 4 is an exploded rear view thereof;

FIG. 5 is an exploded right side view with a left side view being a mirror image thereof;

FIG. 6 is an exploded top view thereof; and,

FIG. 7 is an exploded bottom view thereof.

The broken line showing of the word “INDICIA” is included for the purpose of illustrating and forms no part of the claimed design.

1 Claim, 7 Drawing Sheets

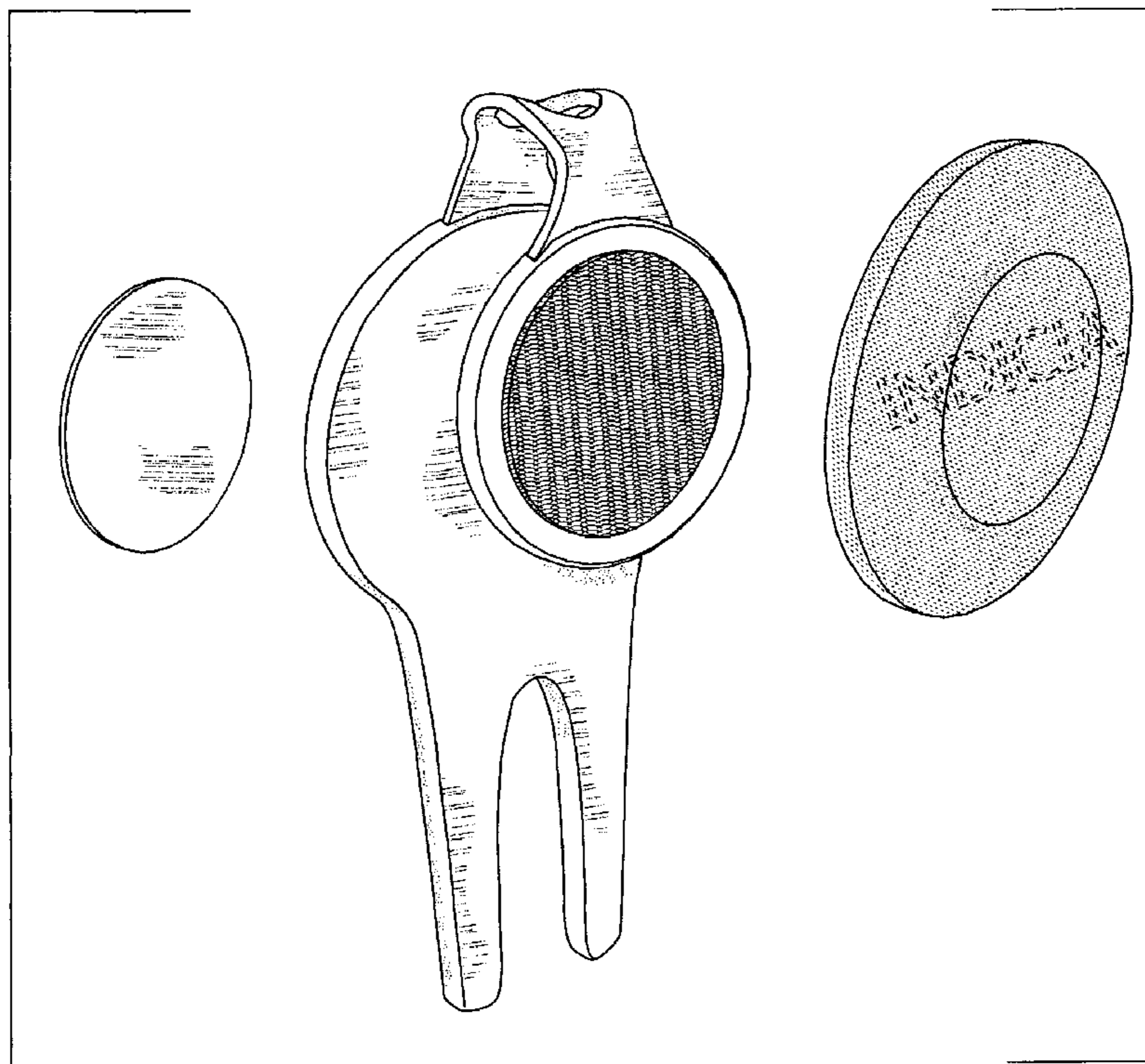

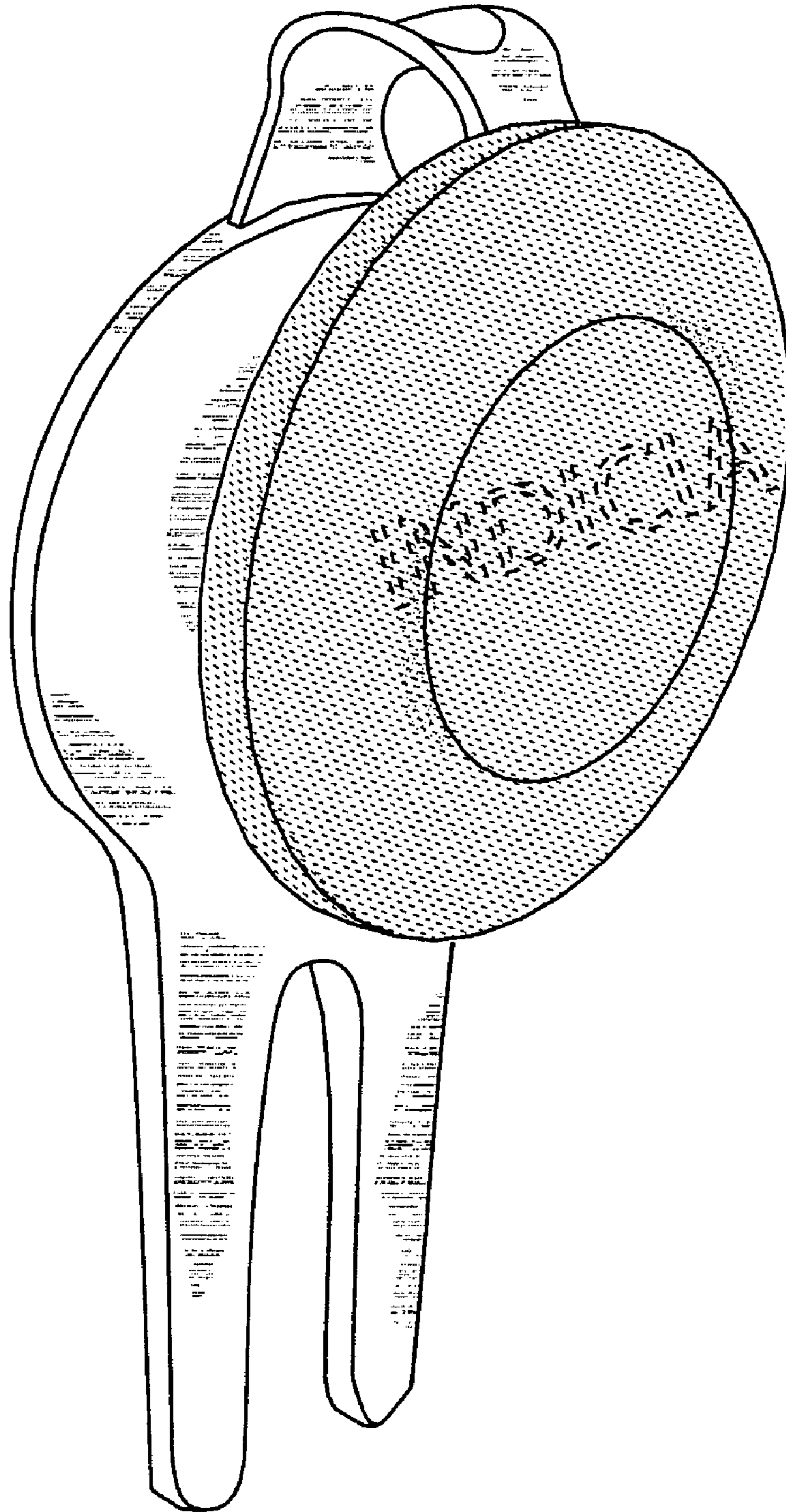

Fig. 1

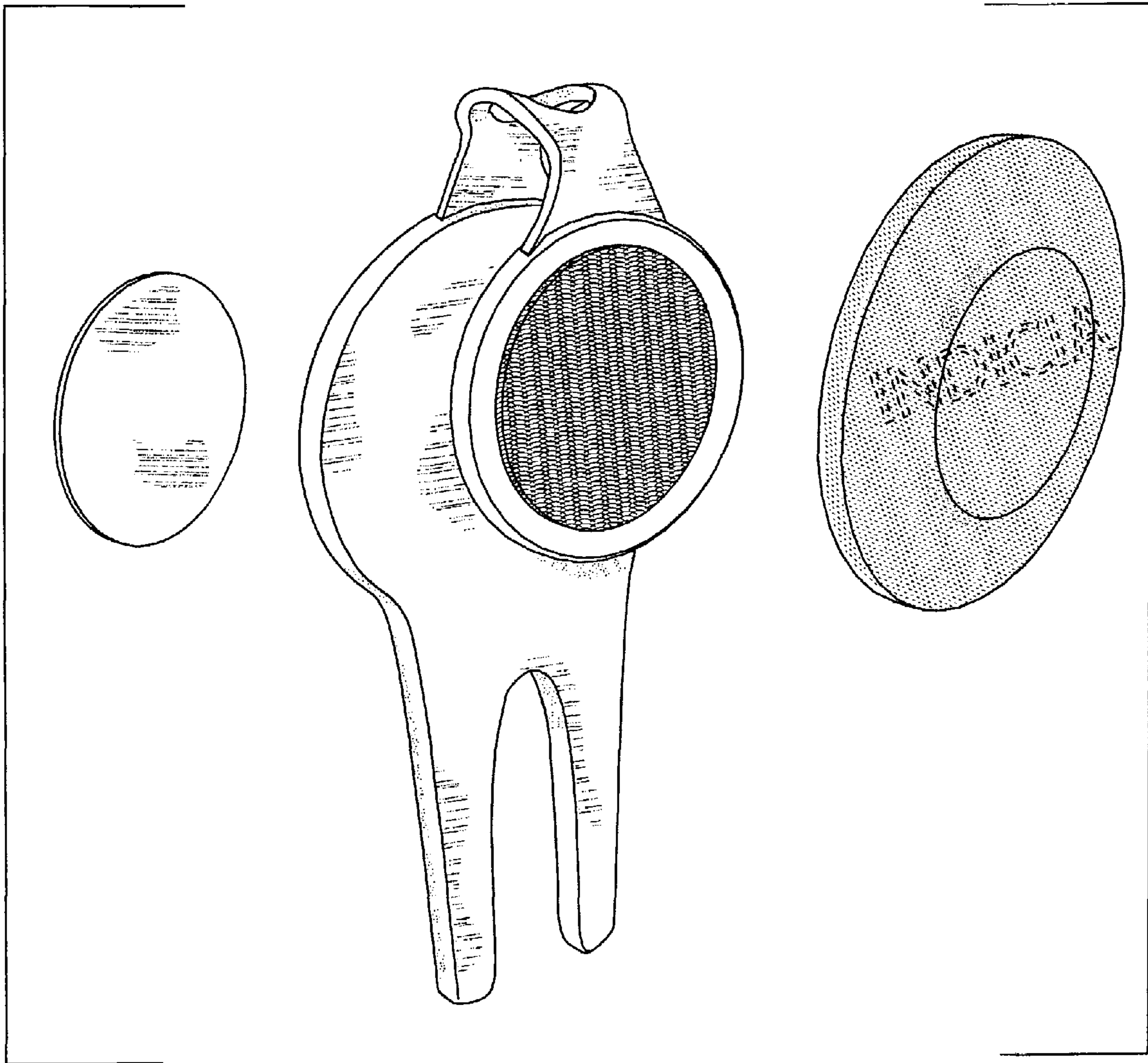

Fig. 2

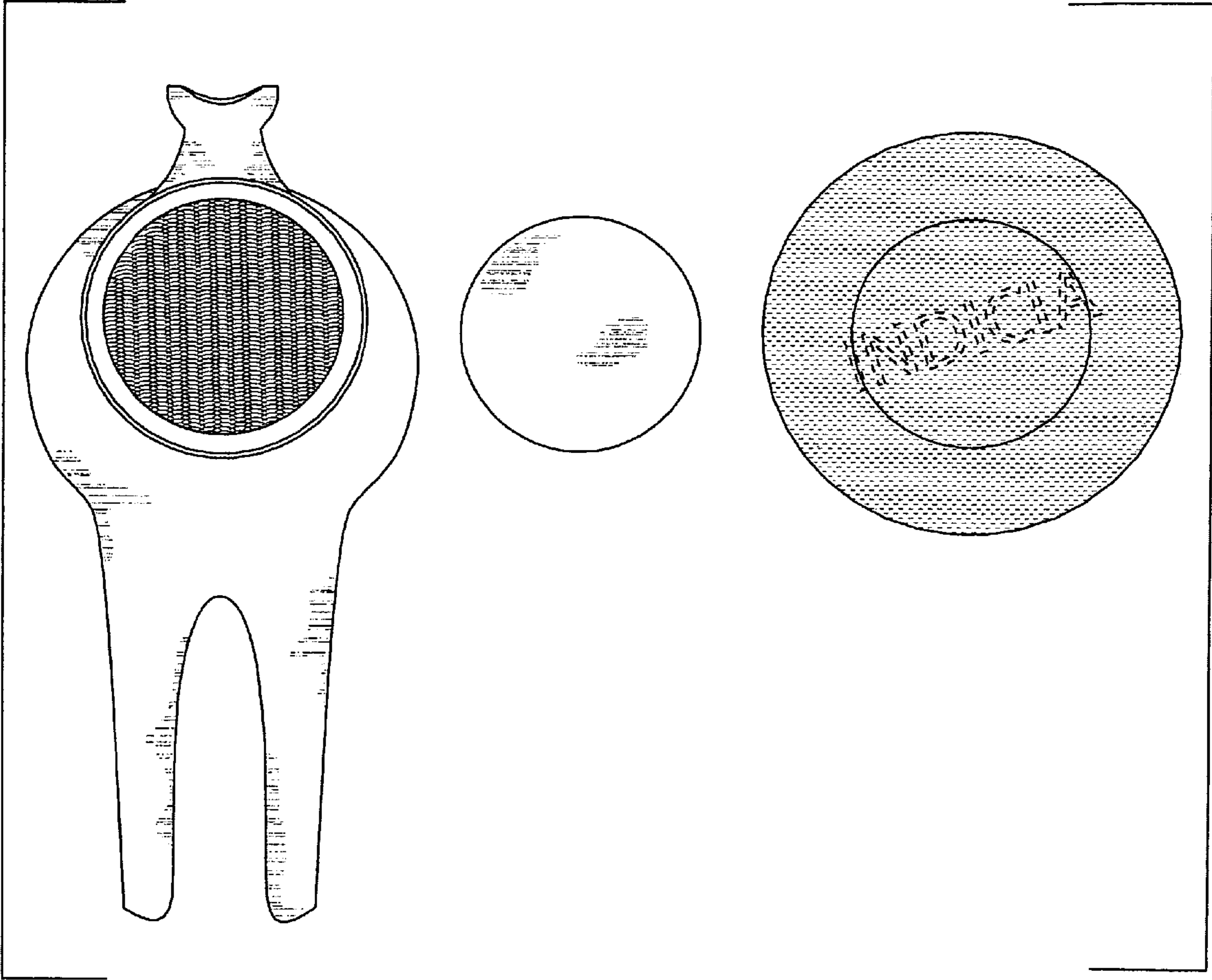

Fig. 3

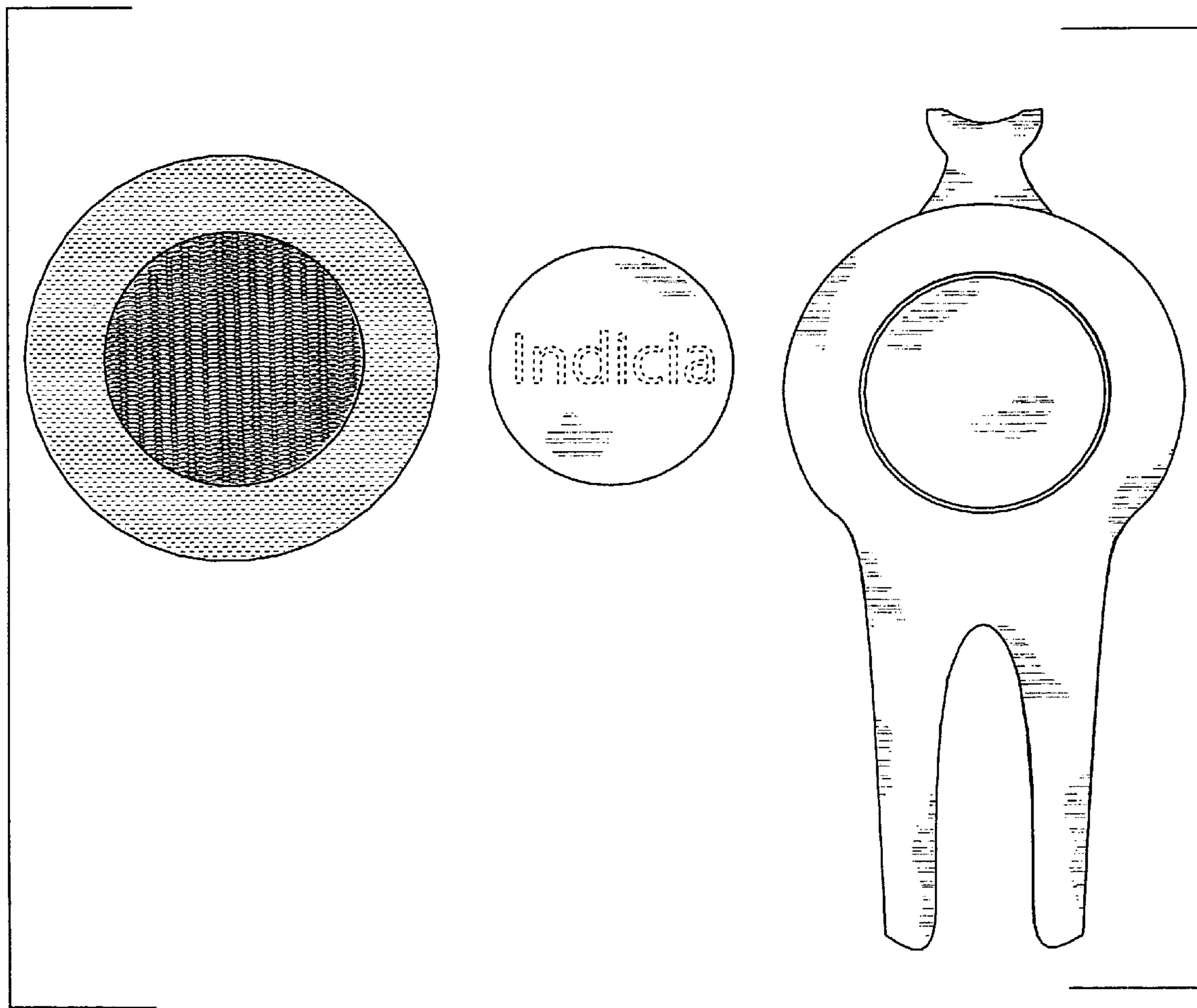

Fig. 4

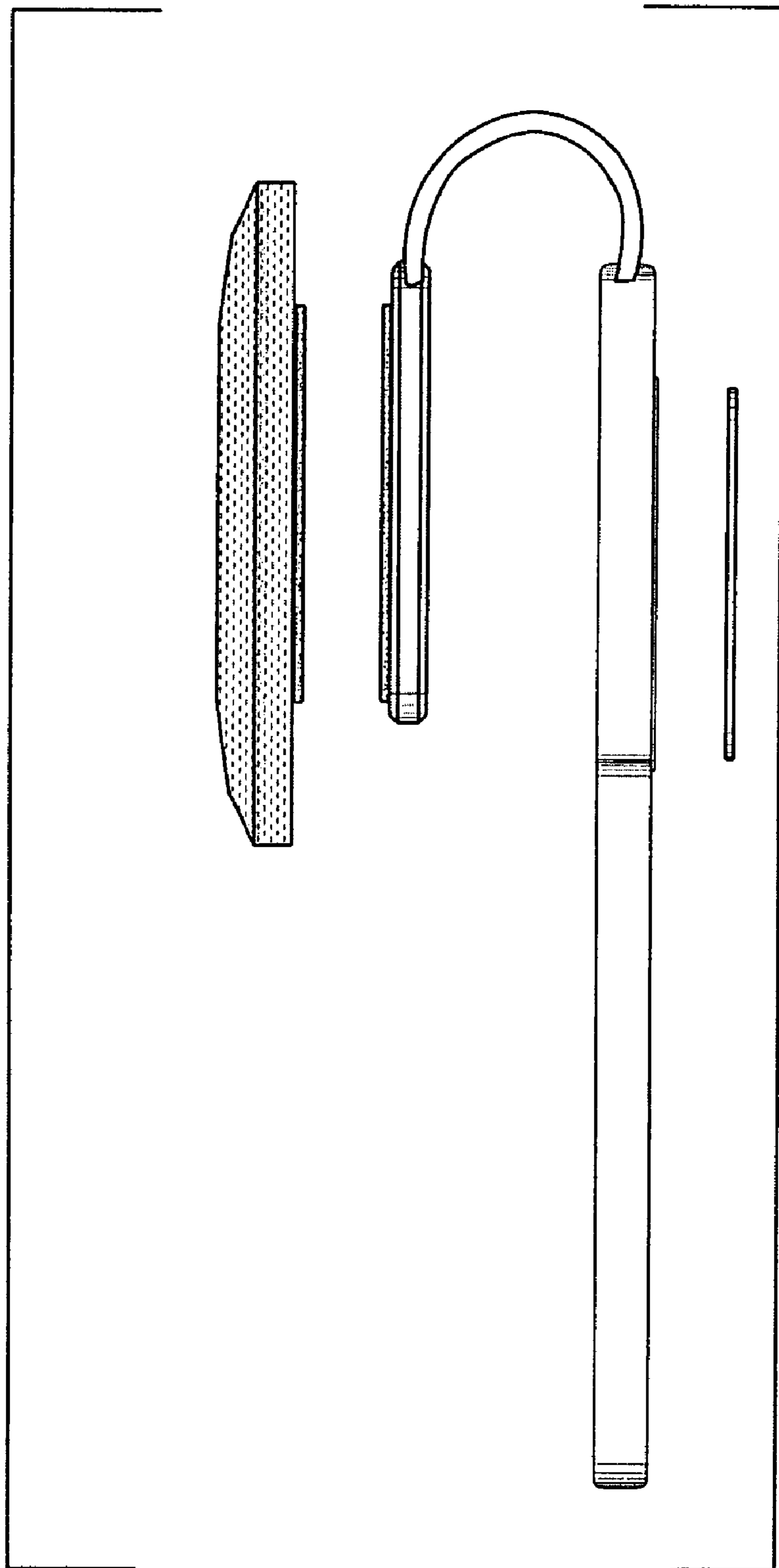

Fig. 5

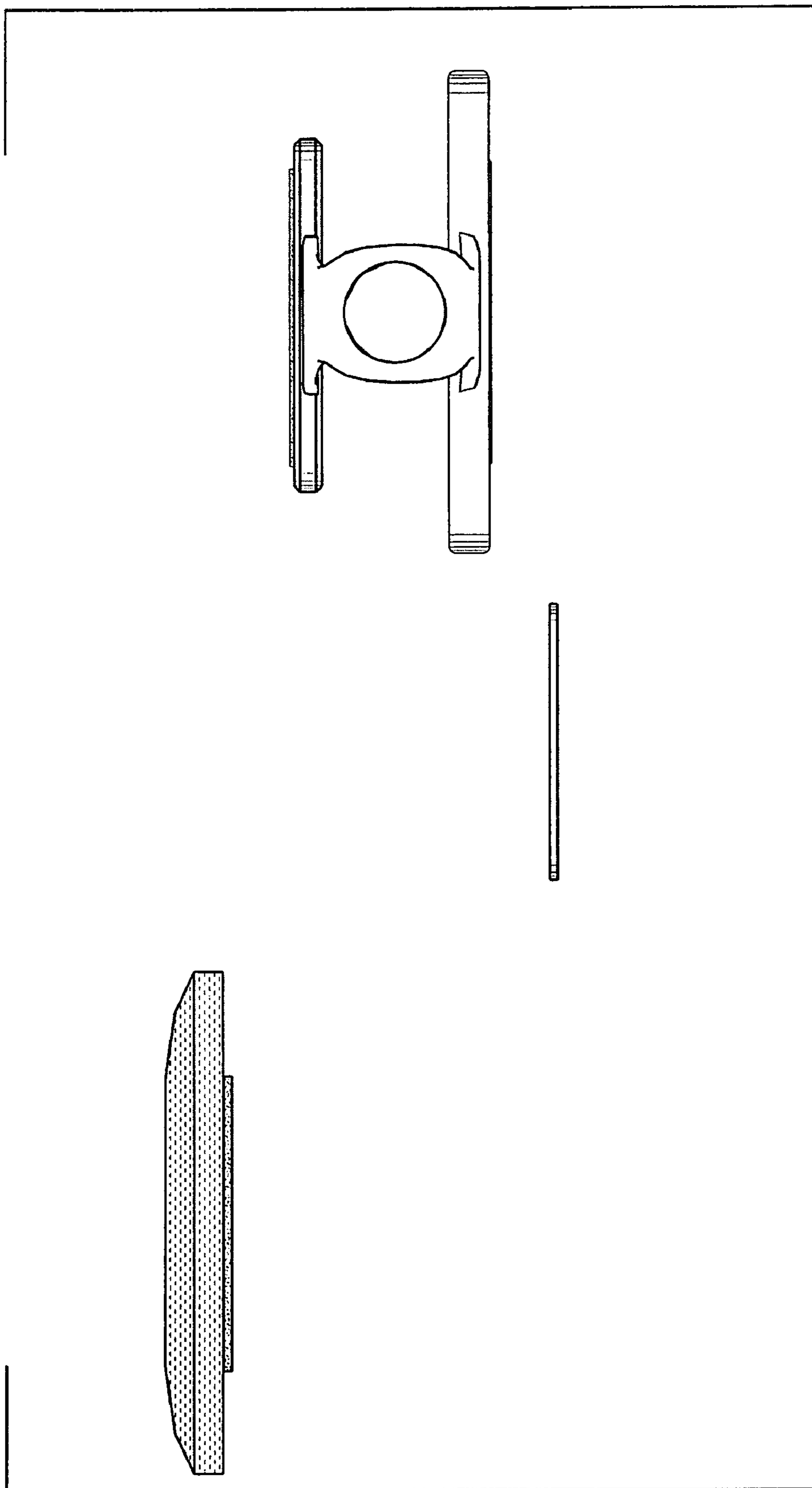

Fig. 6

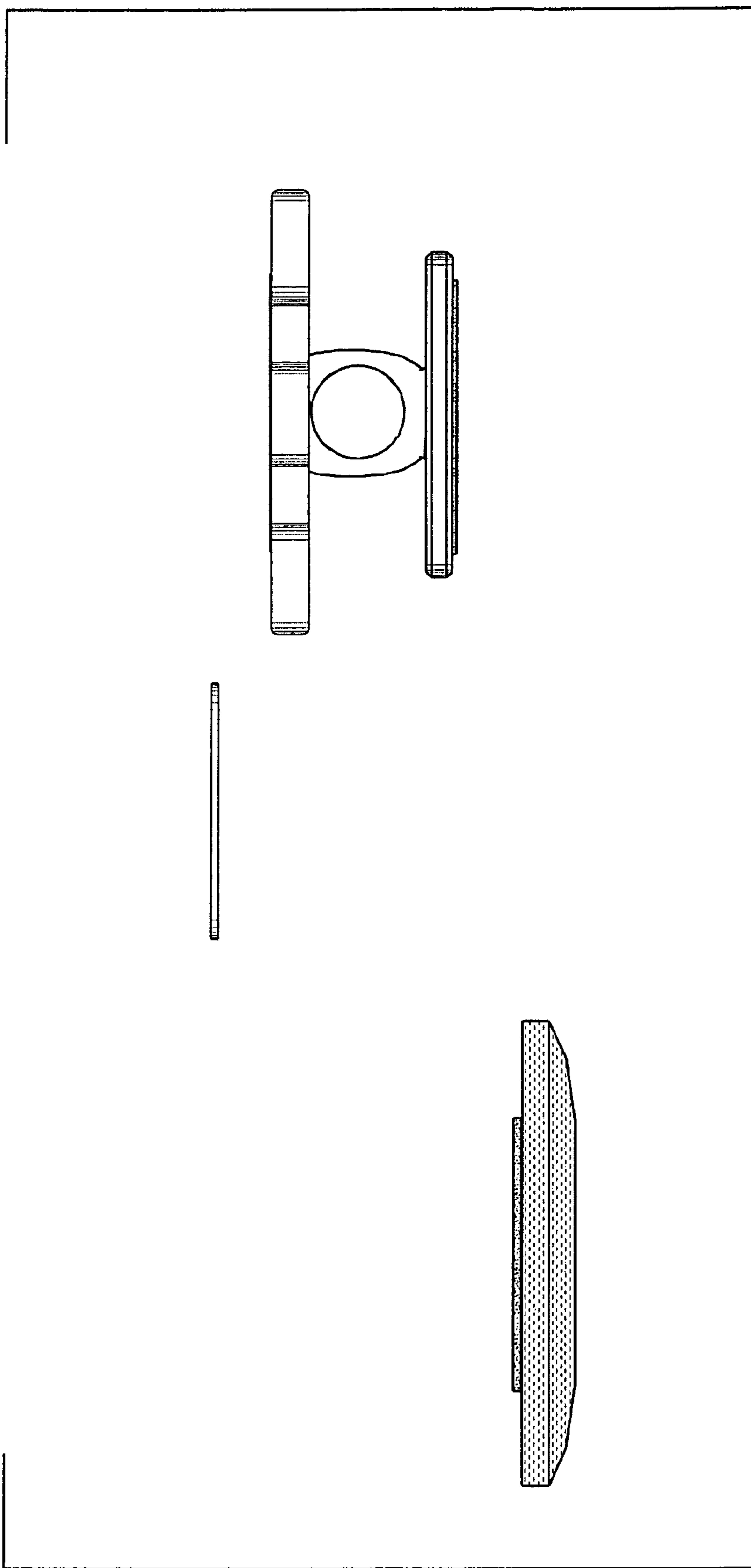

Fig. 7