



US00D603759S

(12) **United States Design Patent**
Nakazawa et al.

(10) **Patent No.:** **US D603,759 S**
(45) **Date of Patent:** **** Nov. 10, 2009**

(54) **MOTORCYCLE OR MOTORCYCLE
REPLICA**

D456,748 S * 5/2002 Keating et al. D12/110
D460,931 S * 7/2002 Nakazawa et al. D12/110
D482,640 S * 11/2003 TaMuRa et al. D12/110

(75) Inventors: **Tetsuya Nakazawa**, Saitama-ken (JP);
Mike Chan, Torrance, CA (US)

* cited by examiner

(73) Assignee: **Honda Motor Co., Ltd.**, Tokyo (JP)

Primary Examiner—Cathron C Brooks

Assistant Examiner—Linda Brooks

(**) Term: **14 Years**

(74) *Attorney, Agent, or Firm*—Westerman, Hattori, Daniels
& Adrian, LLP.

(21) Appl. No.: **29/304,559**

(57) **CLAIM**

(22) Filed: **Mar. 4, 2008**

The ornamental design for a motorcycle or motorcycle replica, thereof as shown and described.

(30) **Foreign Application Priority Data**

DESCRIPTION

Sep. 5, 2007 (JP) 2007-024212

FIG. 1 is a perspective view from the left side of a motorcycle or motorcycle replica thereof.

(51) **LOC (9) Cl.** **12-11**

FIG. 2 is a perspective view from the right side thereof.

(52) **U.S. Cl.** **D12/110**

FIG. 3 is a perspective view from the left side thereof.

(58) **Field of Classification Search** D12/110;
180/219, 220, 225, 229

FIG. 4 is a perspective view from the right side thereof.

See application file for complete search history.

FIG. 5 is a front elevation view thereof.

(56) **References Cited**

FIG. 6 is a rear elevation view thereof.

U.S. PATENT DOCUMENTS

FIG. 7 is a left side elevation view thereof.

D375,281 S * 11/1996 Kitagawa et al. D12/110

FIG. 8 is a right side elevation view thereof.

D417,173 S * 11/1999 Yamaguchi et al. D12/110

FIG. 9 is a top plan view thereof; and,

D426,174 S * 6/2000 Sofue et al. D12/110

FIG. 10 is a bottom plan view thereof.

D442,892 S * 5/2001 Timmermann D12/110

D453,126 S * 1/2002 Nakazawa et al. D12/110

D454,094 S * 3/2002 Miwa et al. D12/110

1 Claim, 10 Drawing Sheets

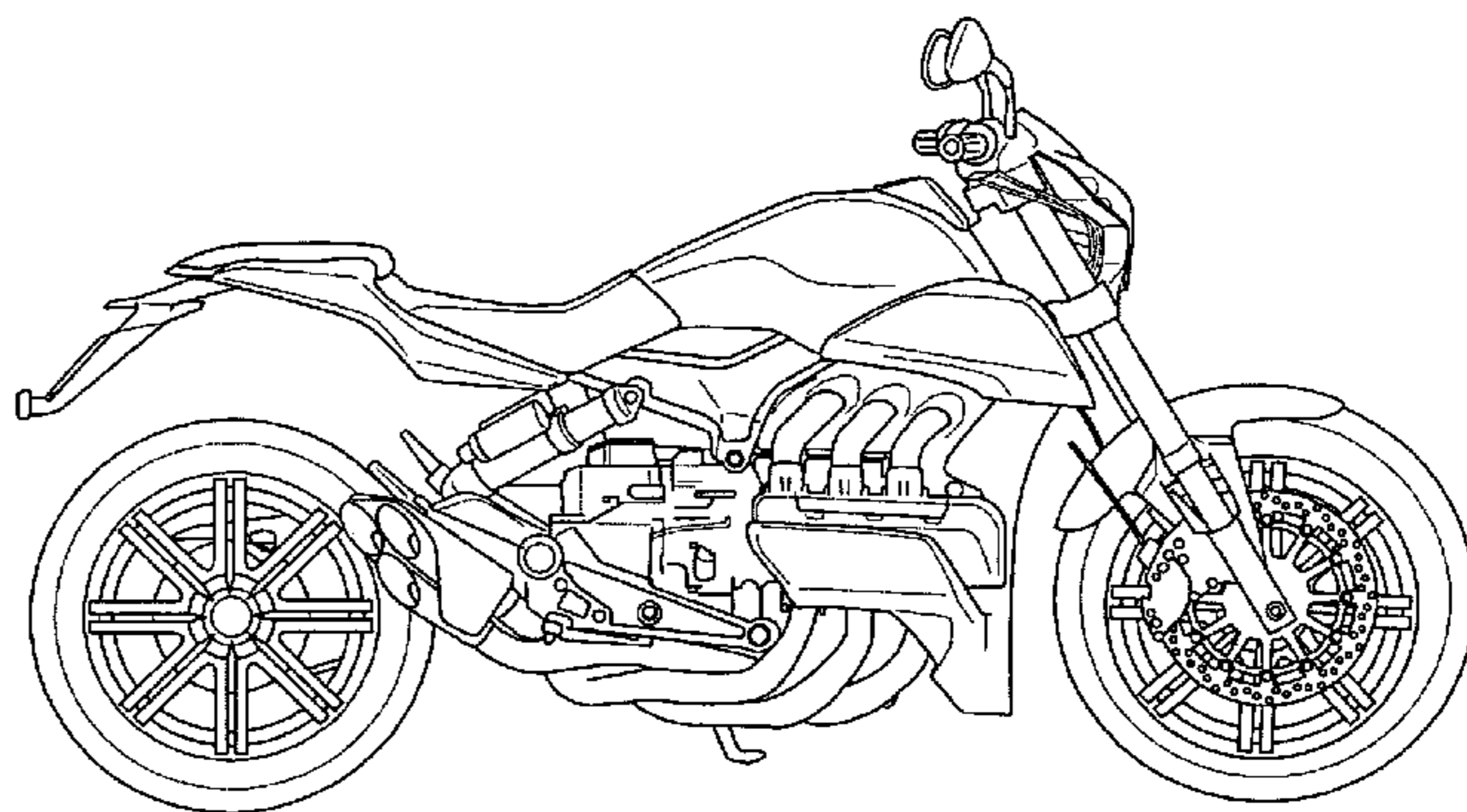
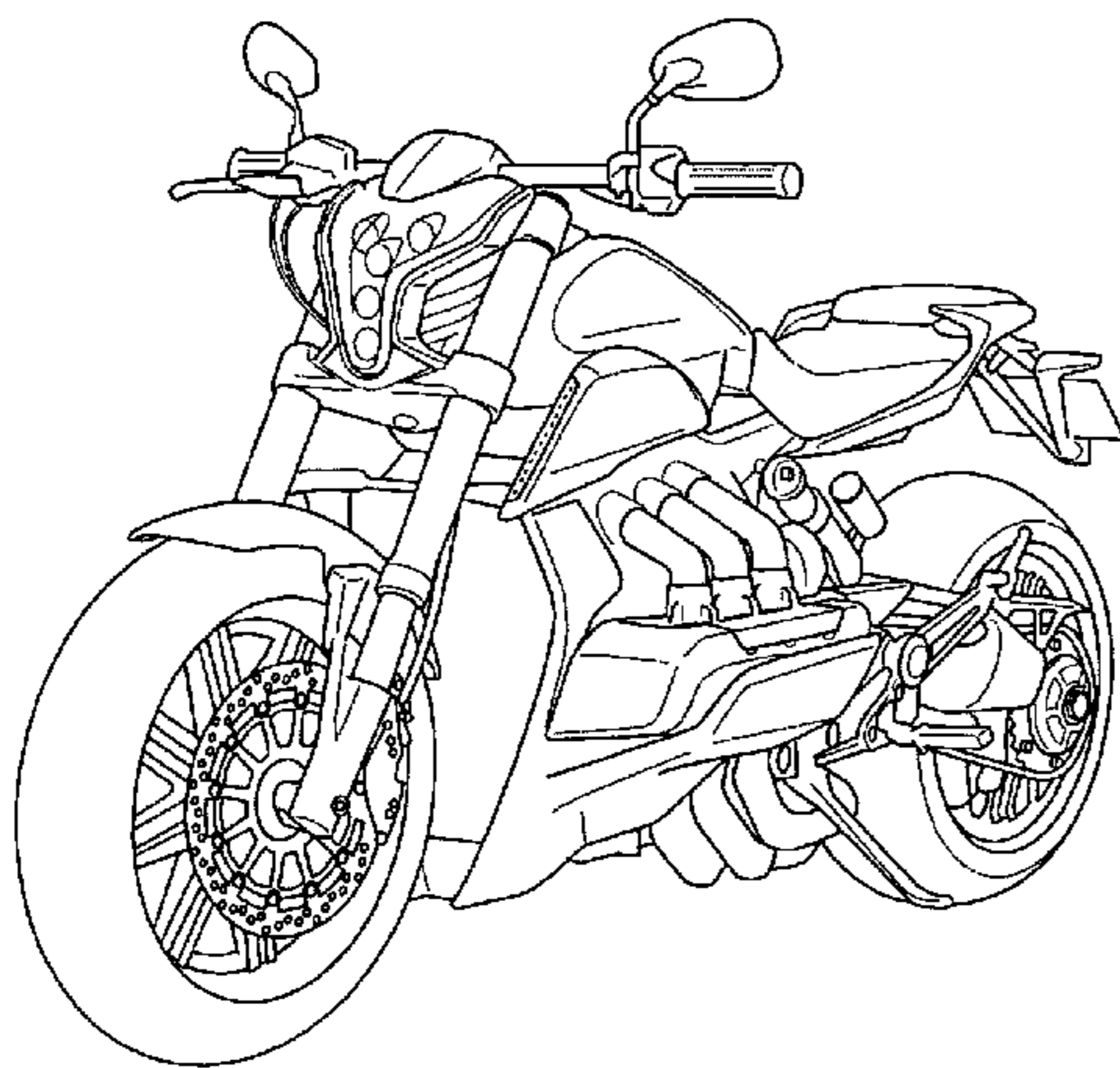

FIG. 1

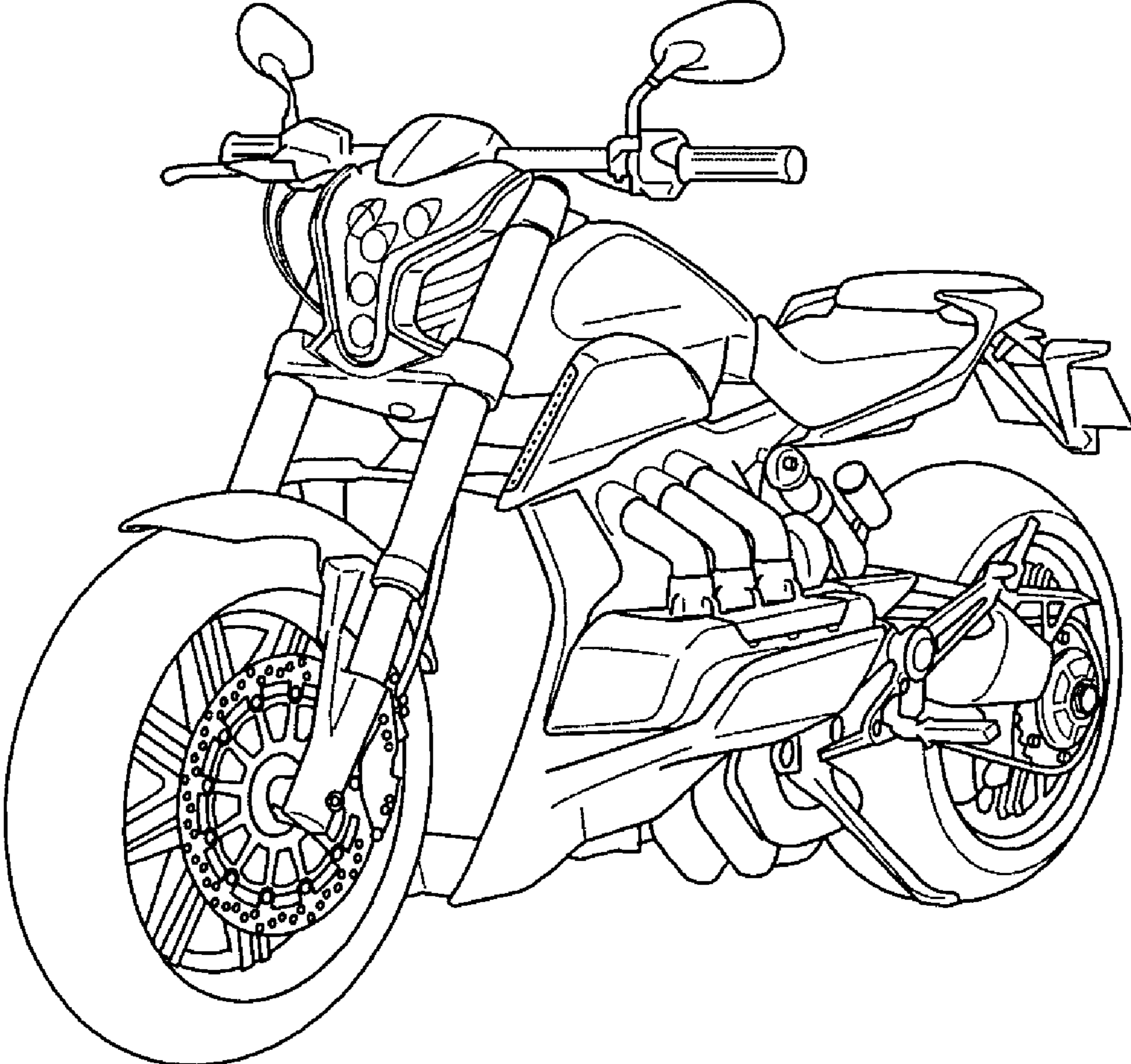

FIG. 2

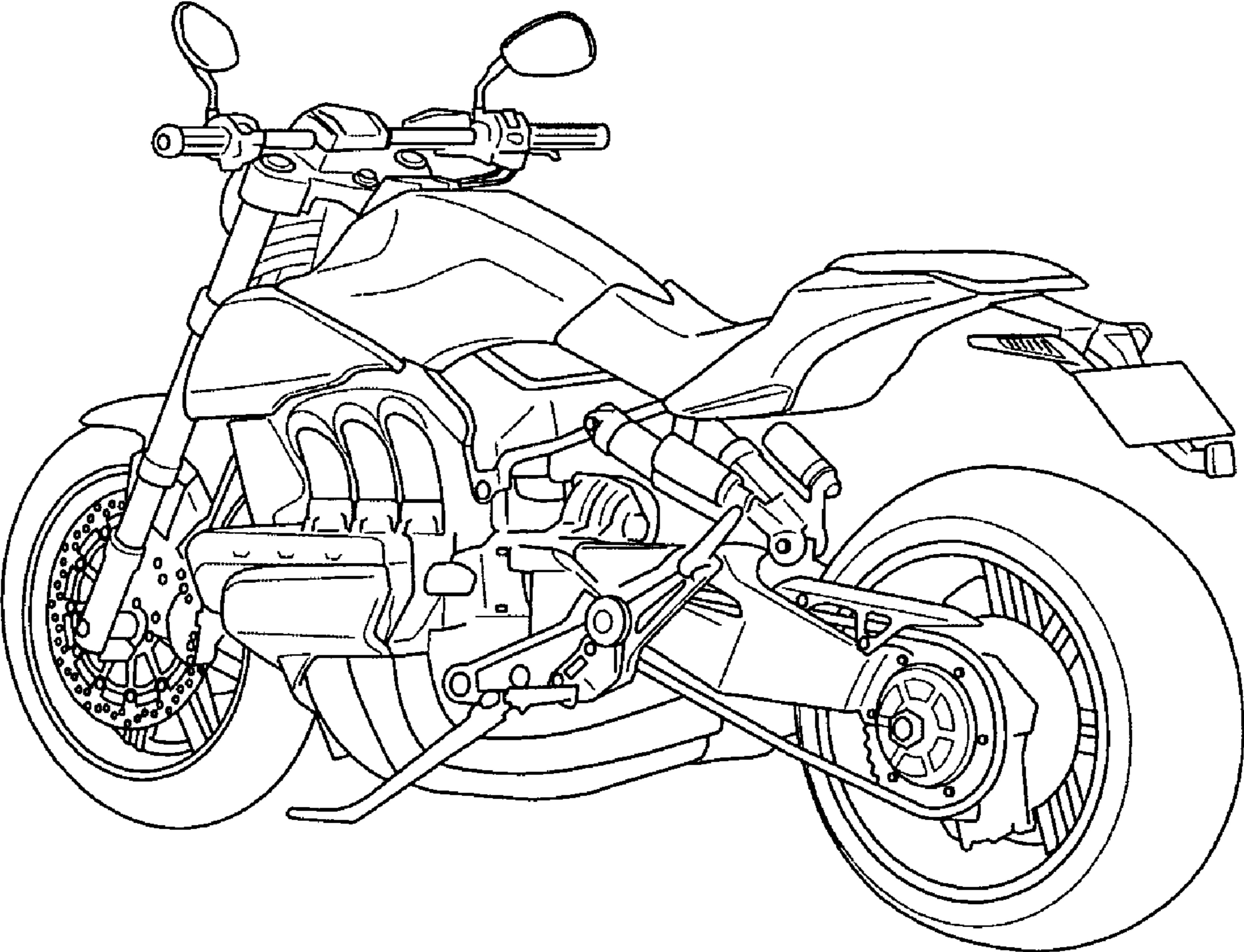

FIG. 3

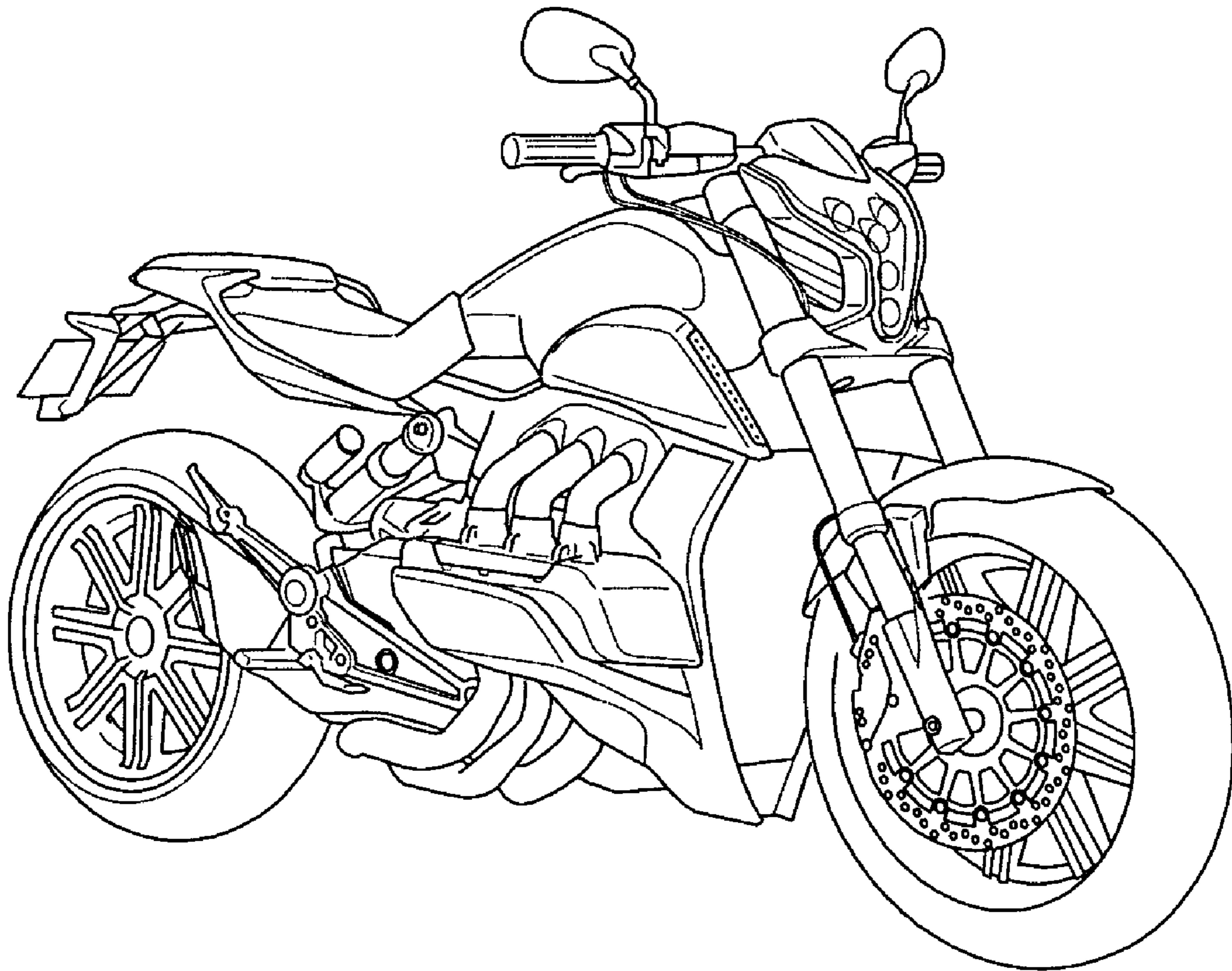

FIG. 4

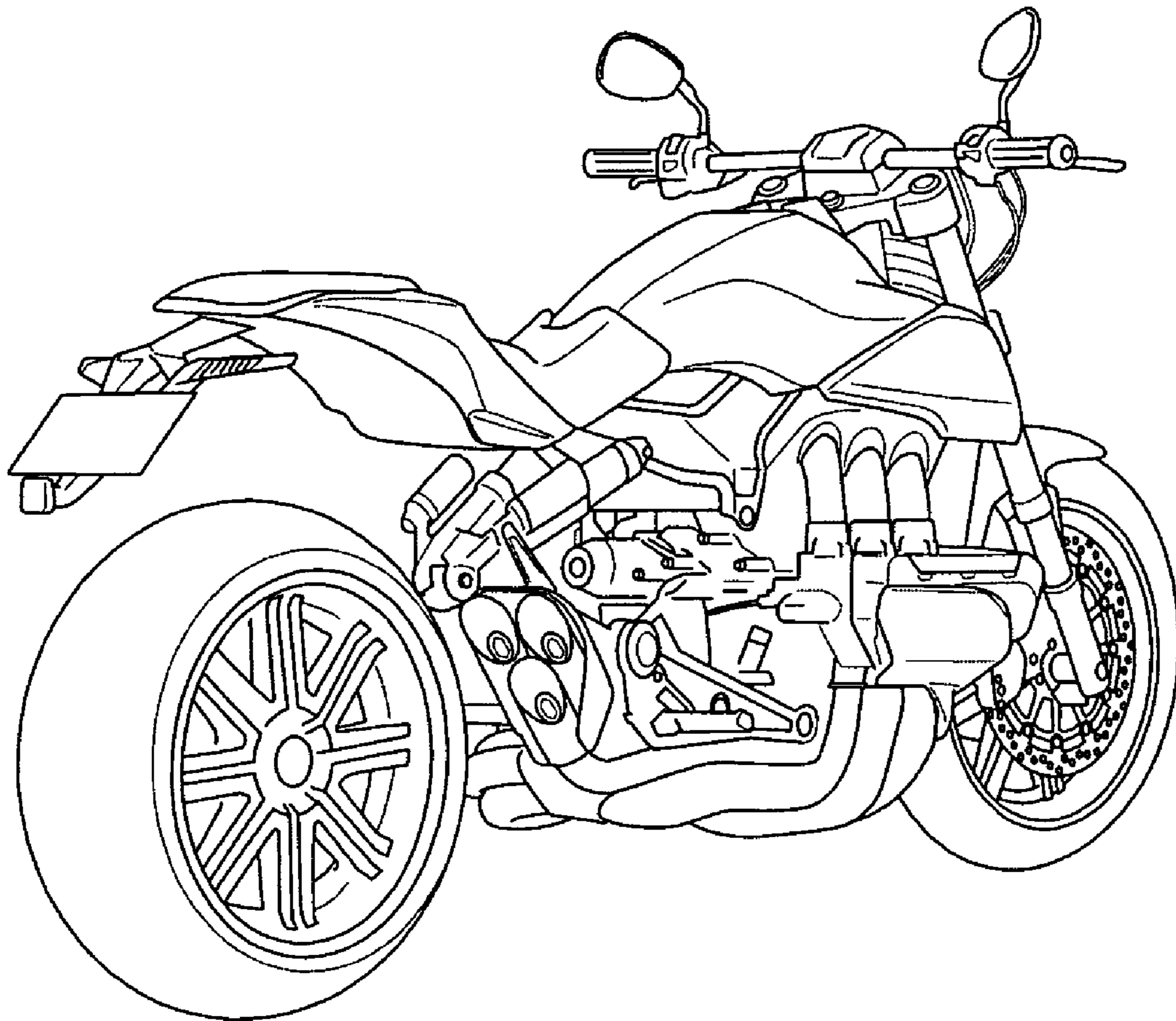

FIG. 5

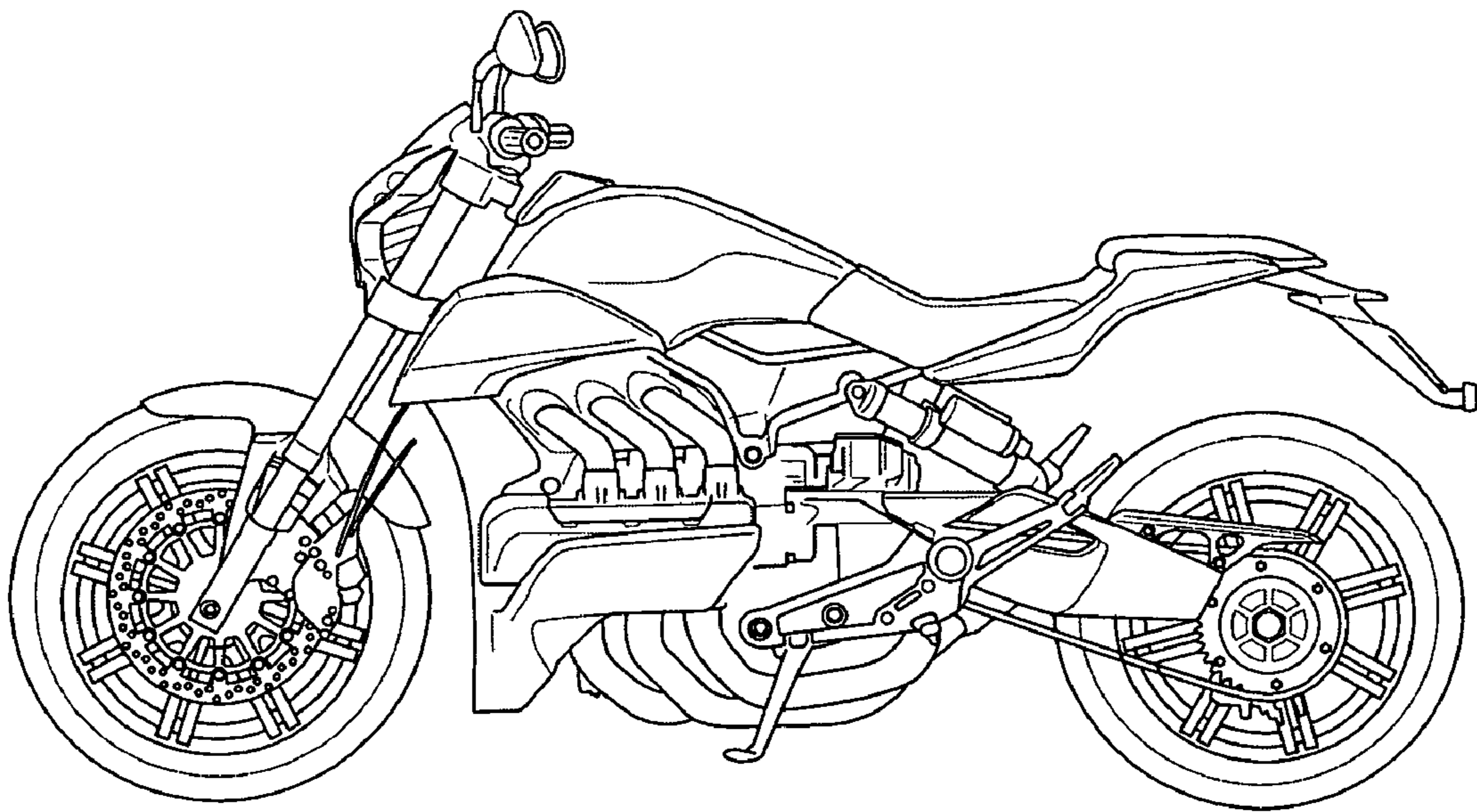

FIG. 6

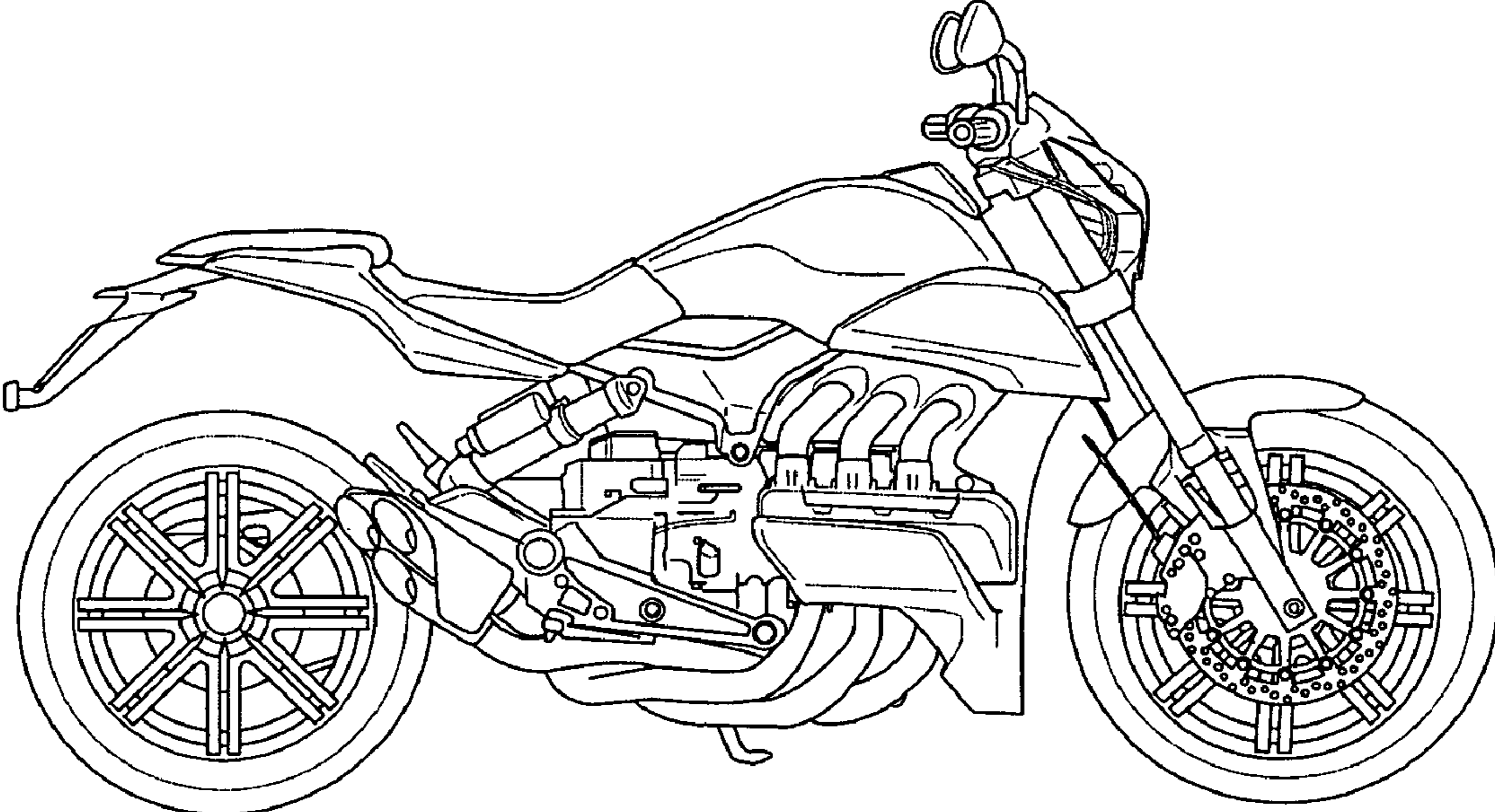

FIG. 7

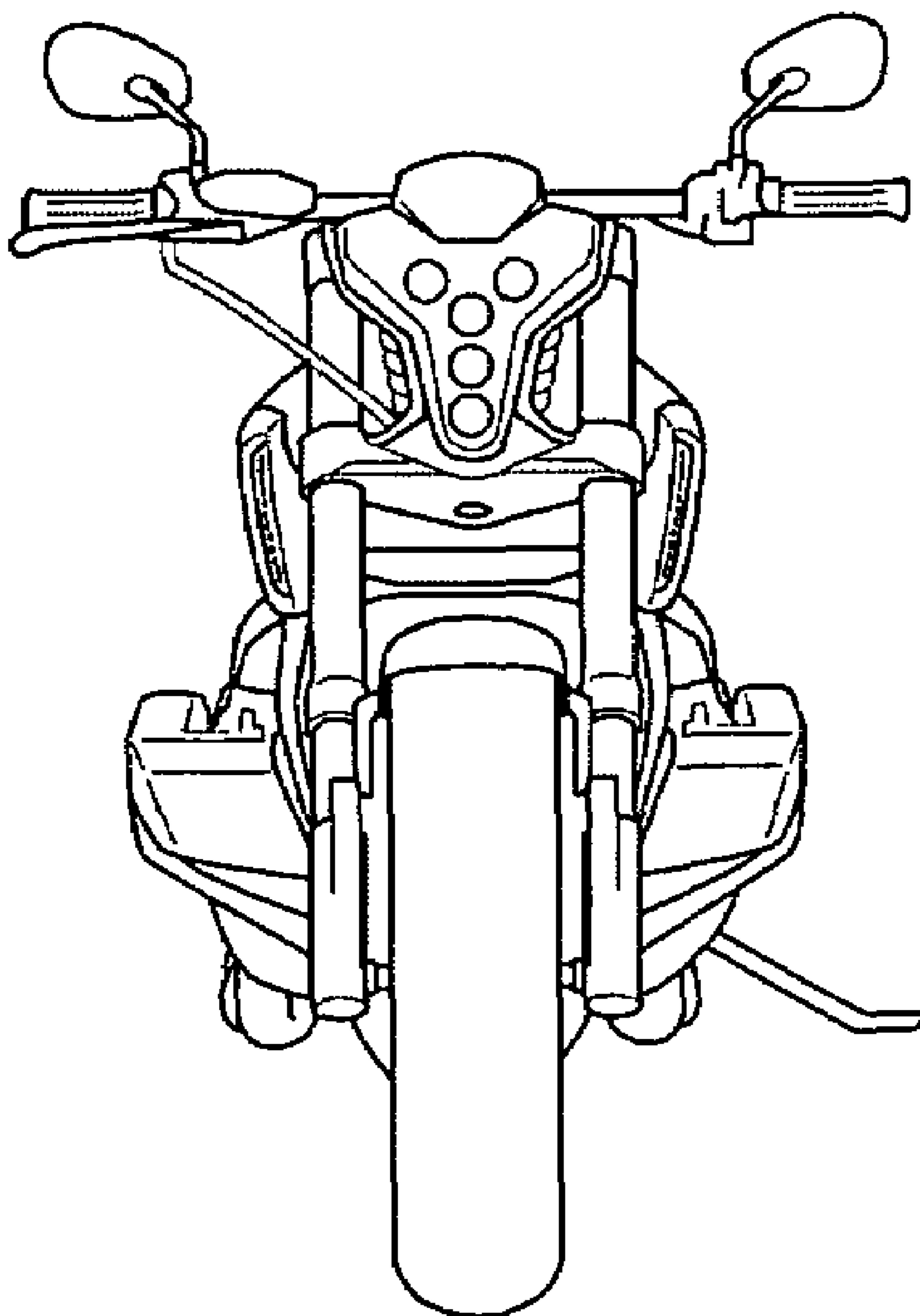

FIG. 8

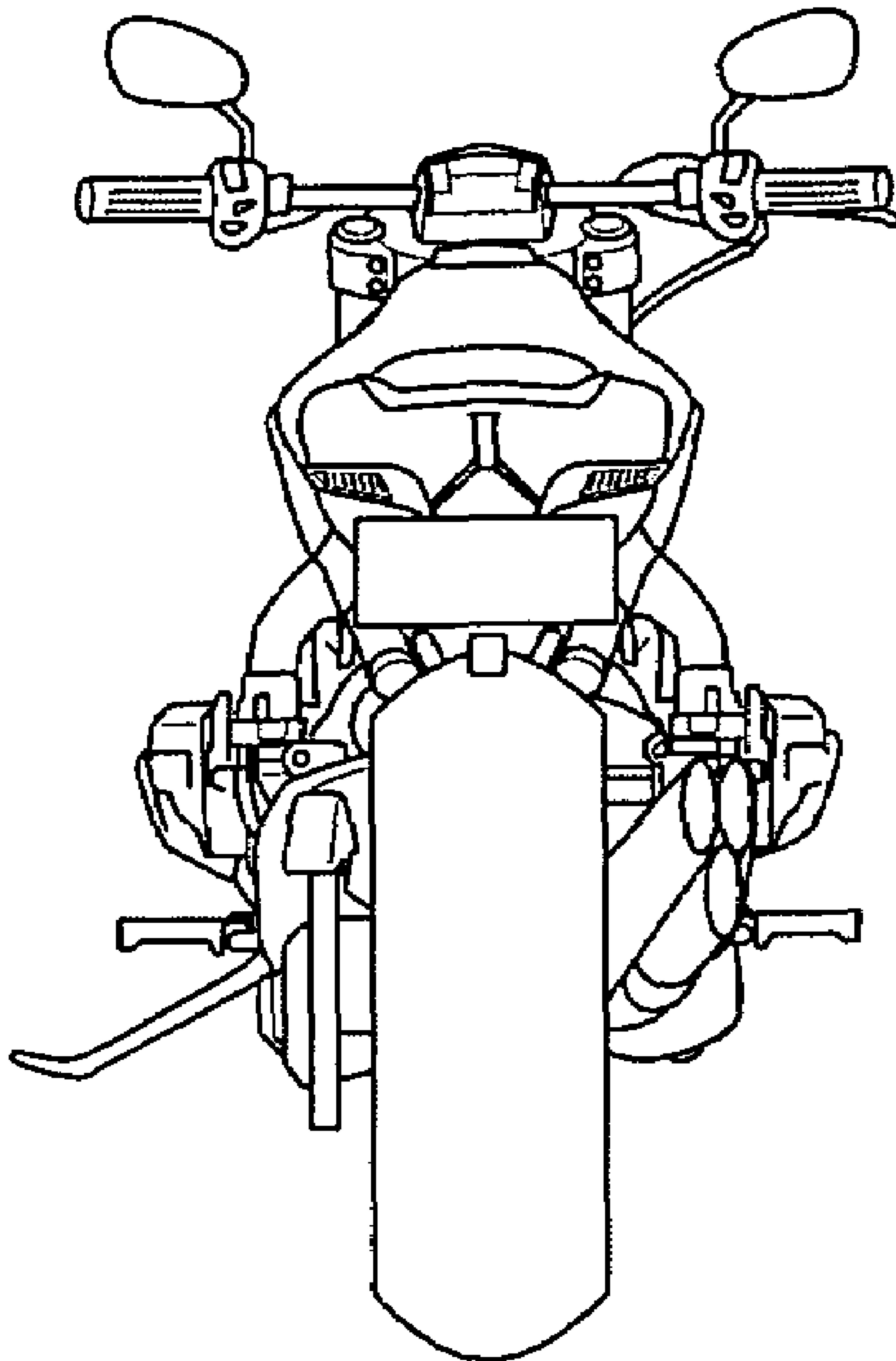

FIG. 9

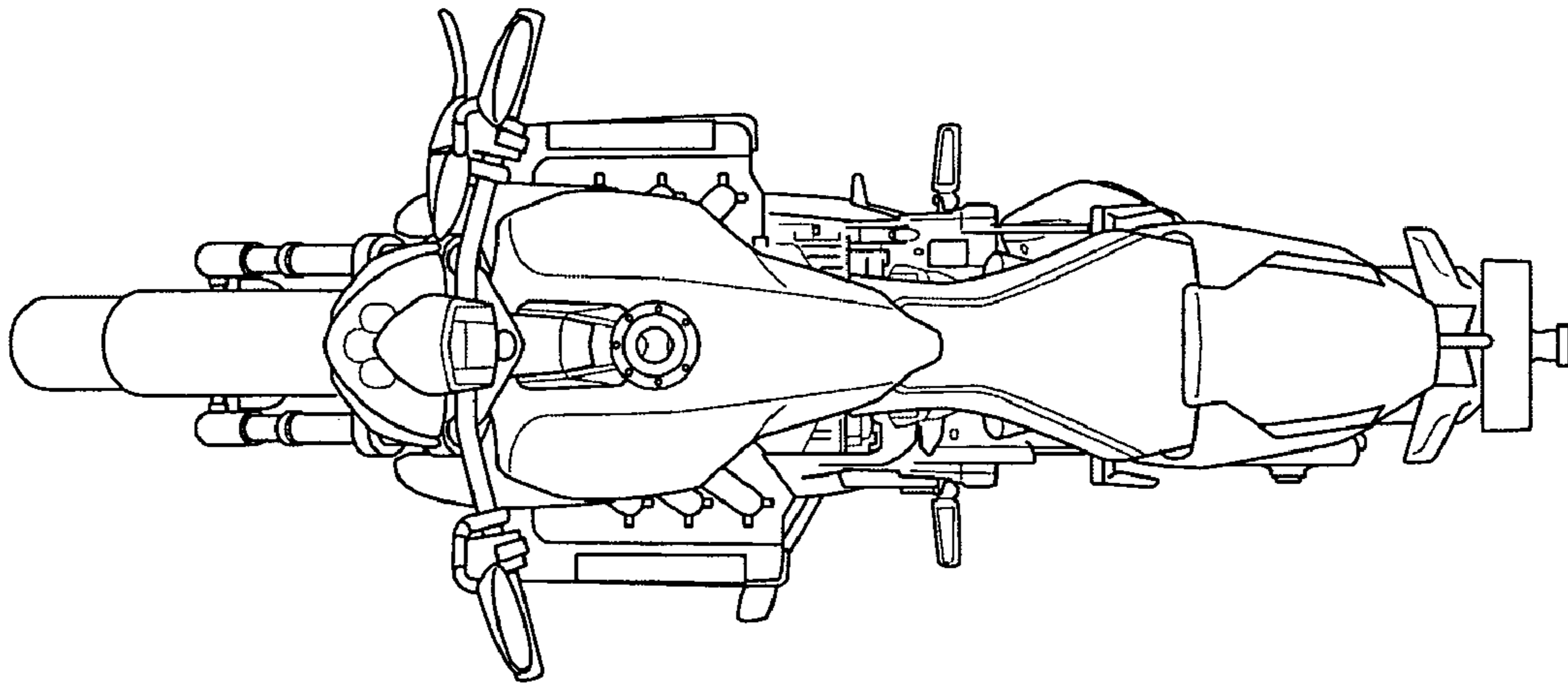

FIG. 10

