

US00D603735S

(12) **United States Design Patent**
Daniels et al.

(10) **Patent No.:** **US D603,735 S**

(45) **Date of Patent:** **** Nov. 10, 2009**

(54) **ZERO SCALE**

D547,682 S * 7/2007 Barmes et al. D10/92
D563,813 S * 3/2008 Tomita et al. D10/92

(76) Inventors: **Donald Wayne Daniels**, 4122 S.
Demaree, Visalia, CA (US) 93227;
James Greg Nunley, 743 Kirk Ct.,
Tulare, CA (US) 93274

* cited by examiner

Primary Examiner—Antoine D Davis
(74) *Attorney, Agent, or Firm*—Thomas, Kayden,
Horstemeyer & Risley, LLP

(**) Term: **14 Years**

(21) Appl. No.: **29/330,881**

(57) **CLAIM**

(22) Filed: **Jan. 15, 2009**

The ornamental design for a zero scale, as shown and described.

(51) **LOC (9) Cl.** **10-04**

(52) **U.S. Cl.** **D10/92**

(58) **Field of Classification Search** D10/92,
D10/93; 177/4, 25.12–25.16, 177, 199, 210 R,
177/238–245, DIG. 3, 262, 210 C, 30, 126–127;
324/692, 512, 515, 806; 600/506, 547
See application file for complete search history.

DESCRIPTION

FIG. 1 is a perspective view showing our new zero scale;
FIG. 2 is a right side view thereof,
FIG. 3 is a left side view thereof,
FIG. 4 is a front view thereof;
FIG. 5 is a back view thereof;
FIG. 6 is a top view thereof; and,
FIG. 7 is a bottom view thereof.

(56) **References Cited**

U.S. PATENT DOCUMENTS

D415,051 S * 10/1999 Fabian D10/92
D475,310 S * 6/2003 Stephens D10/92

1 Claim, 5 Drawing Sheets

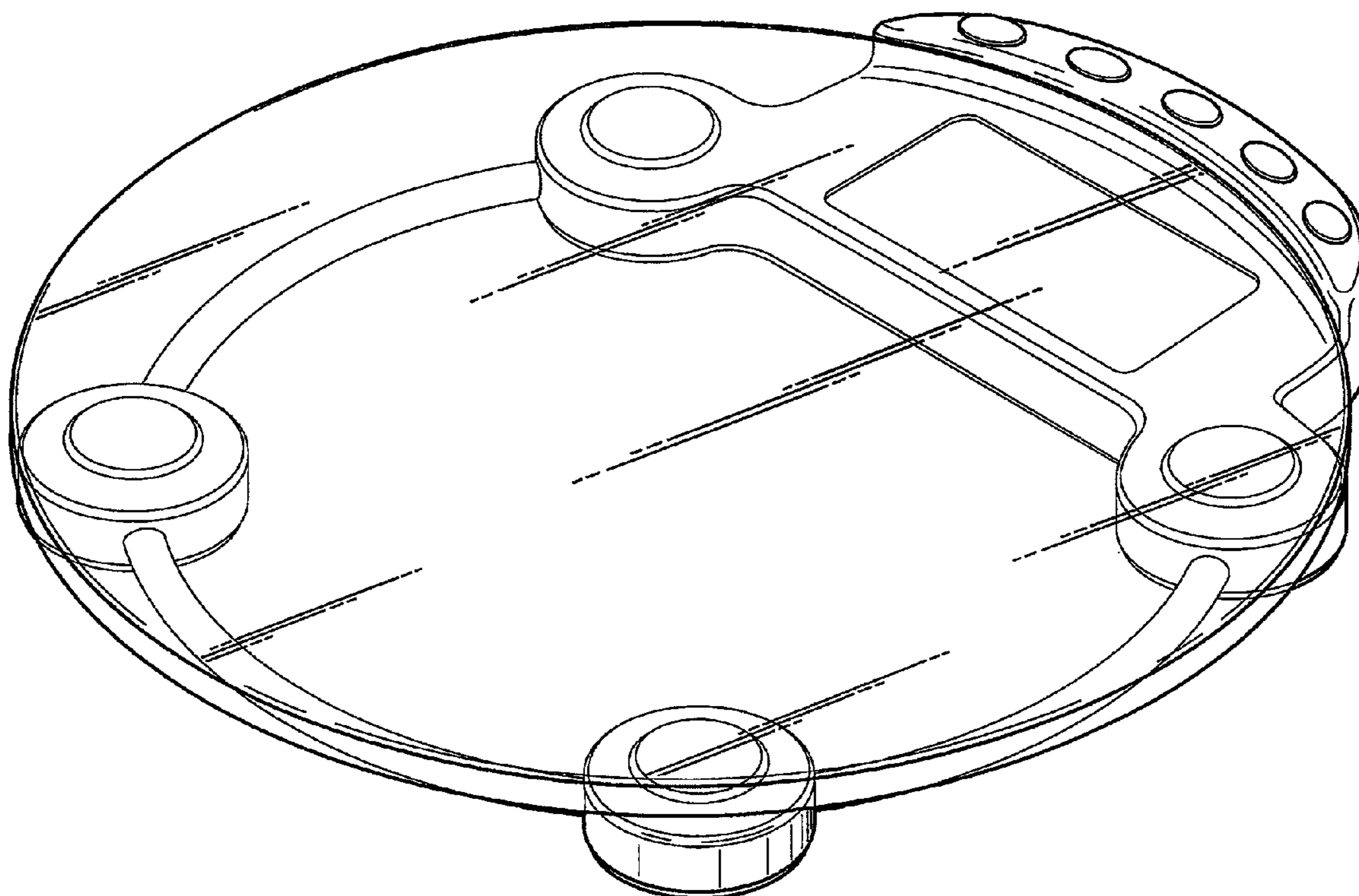

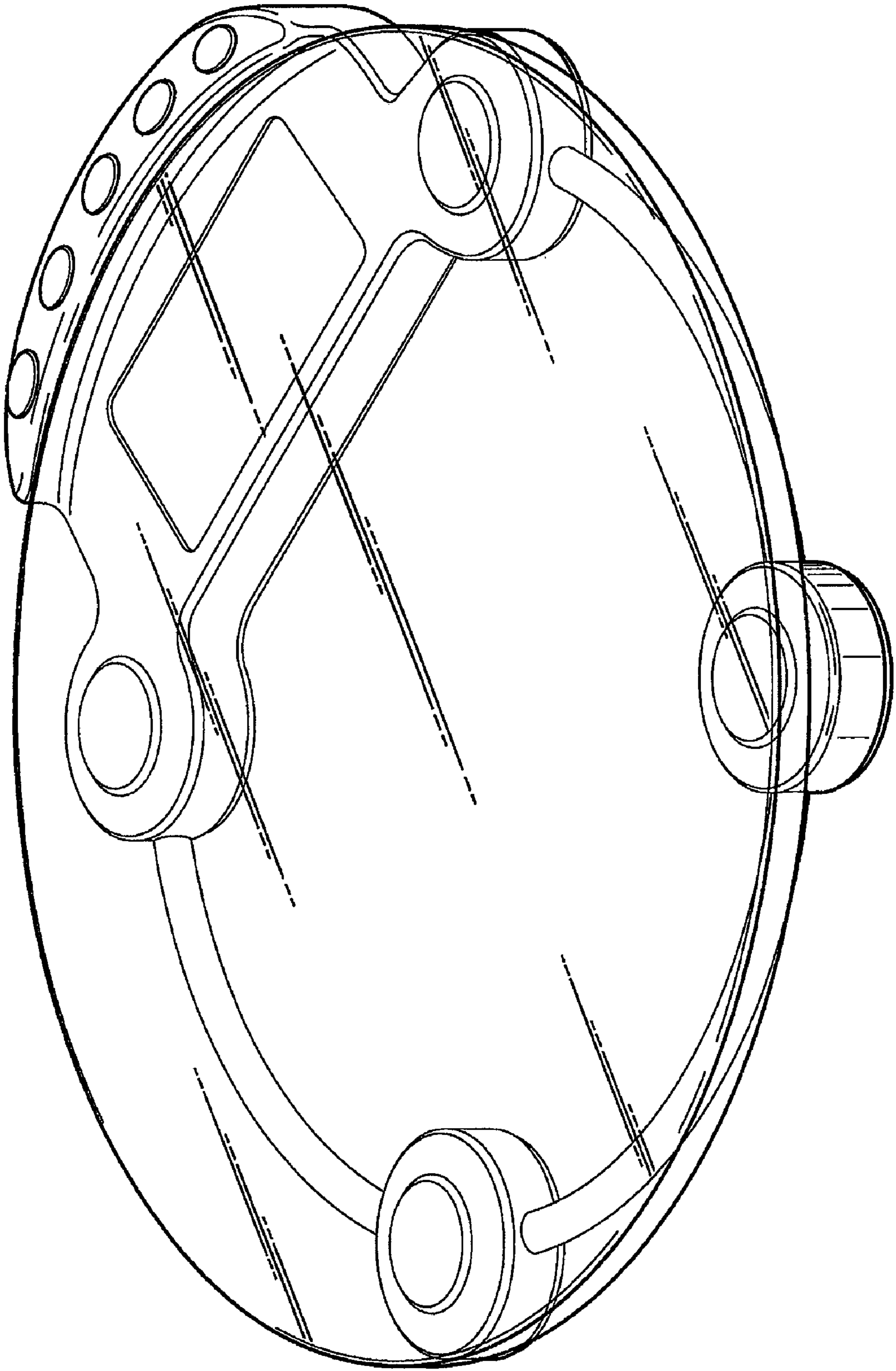

Fig. 1

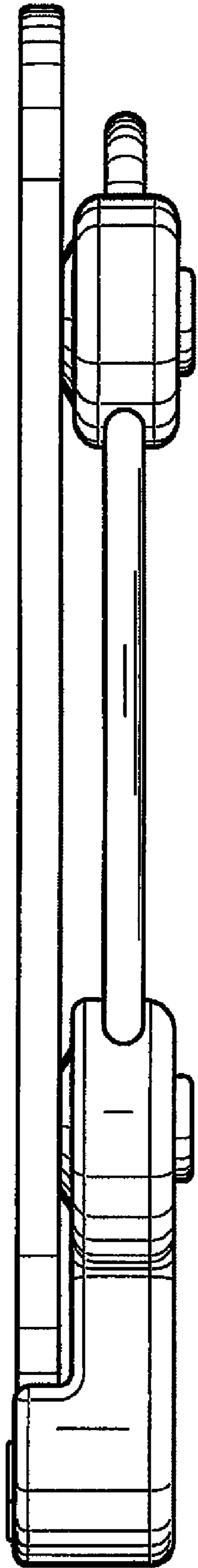

Fig. 2

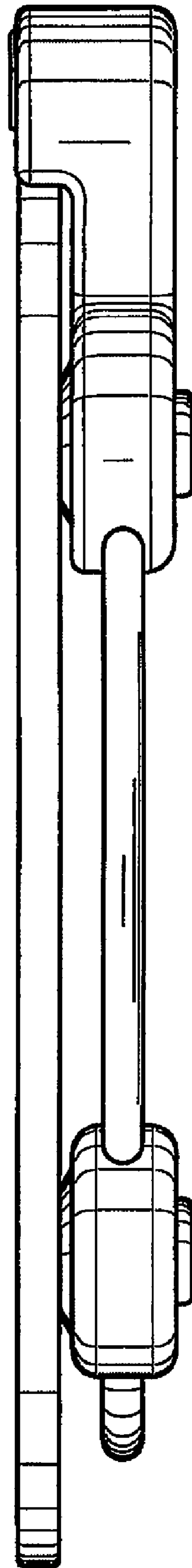

Fig. 3

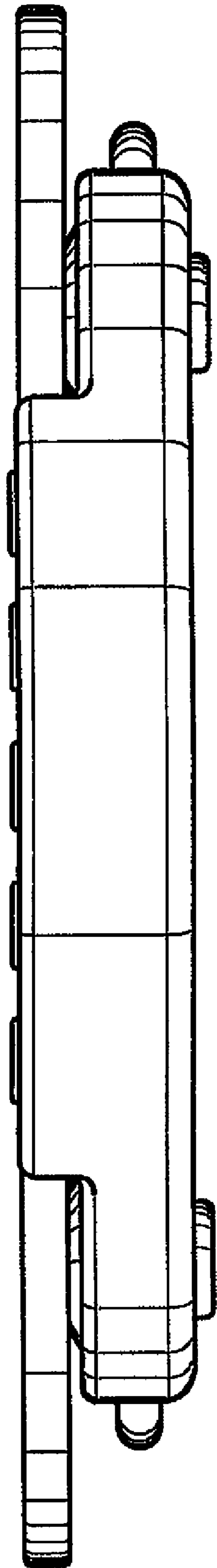

Fig. 4

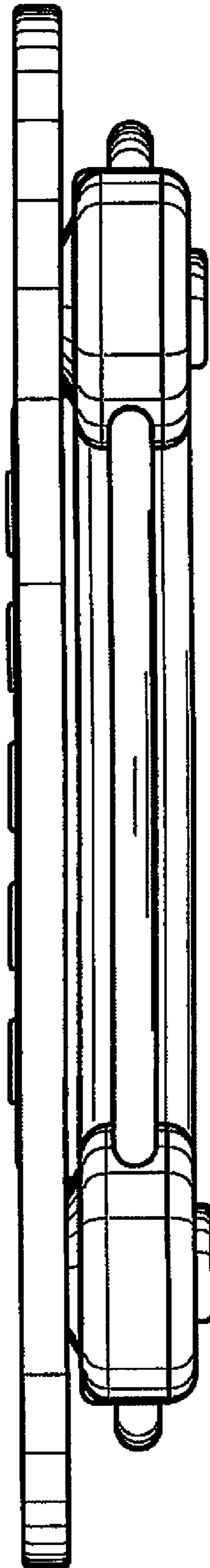

Fig. 5

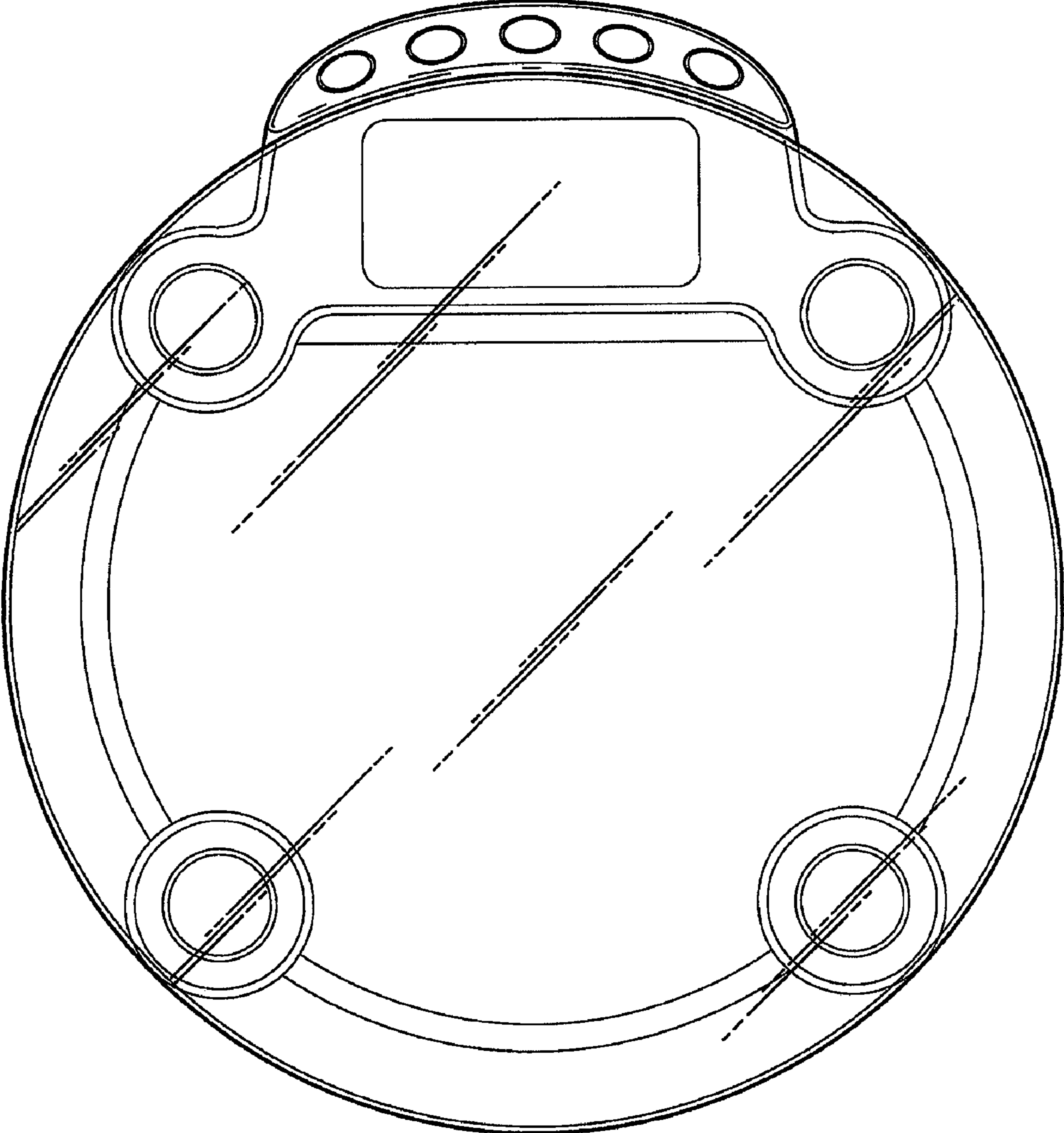

Fig. 6

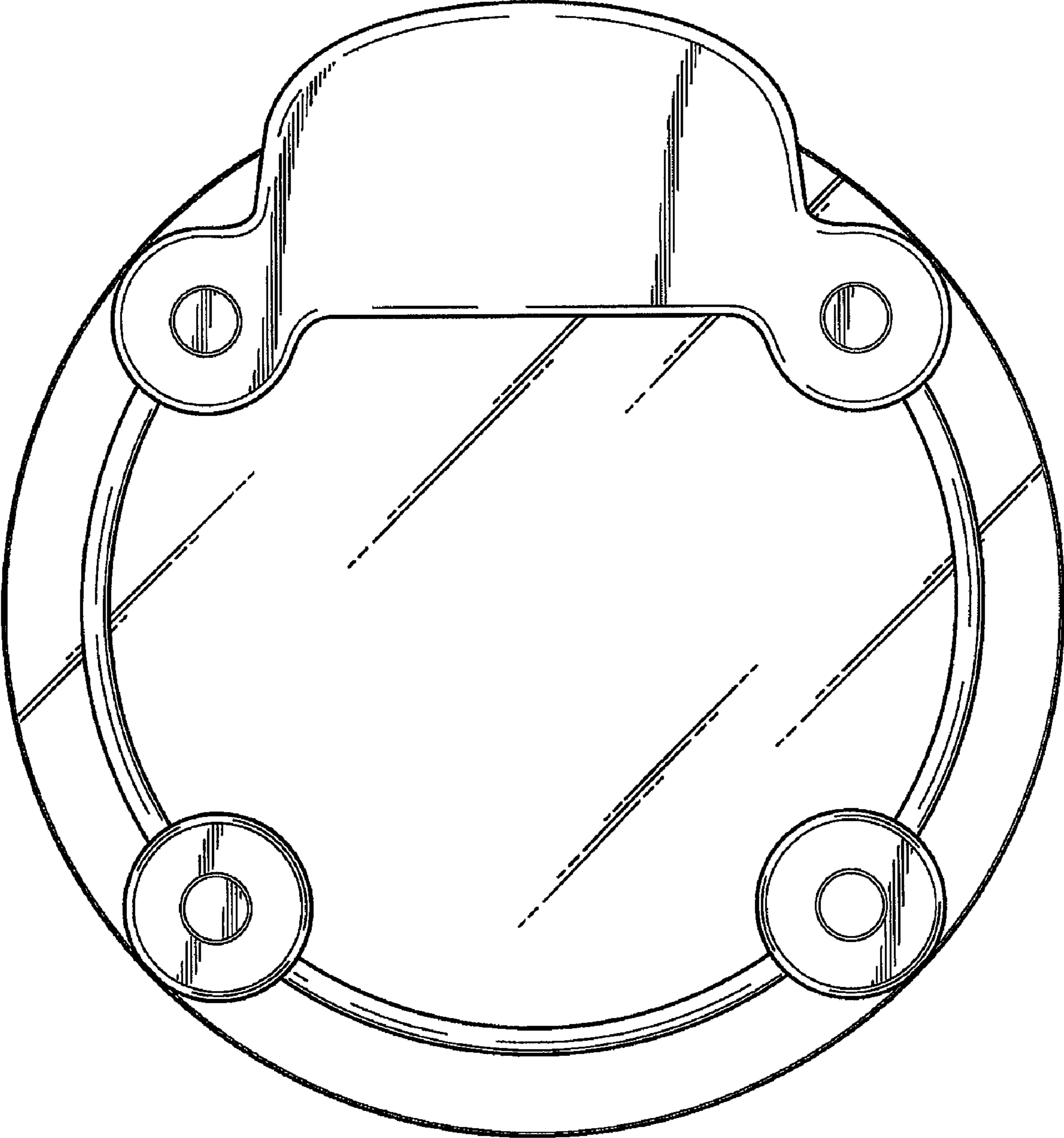

Fig. 7