



US00D603627S

(12) **United States Design Patent**
Wen

(10) **Patent No.:** **US D603,627 S**

(45) **Date of Patent:** **** Nov. 10, 2009**

(54) **DESK**

(75) Inventor: **James Wen**, Irvine, CA (US)

(73) Assignee: **Elite Manufacturing Corporation**,
Santa Fe Springs, CA (US)

(**) Term: **14 Years**

(21) Appl. No.: **29/324,917**

(22) Filed: **Sep. 23, 2008**

(51) **LOC (9) Cl.** **06-03**

(52) **U.S. Cl.** **D6/484; D6/487**

(58) **Field of Classification Search** D6/480-489,
D6/495-499, 429-431; 108/153.1, 155,
108/156, 161, 150, 50.01, 50.02; 248/188,
248/188.1, 188.8, 188.9

See application file for complete search history.

(56) **References Cited**

U.S. PATENT DOCUMENTS

D220,704 S * 5/1971 Kramer D6/484

D242,102 S 11/1976 Stirling

D244,114 S * 4/1977 Neff D6/484

D267,458 S 1/1983 McKinnon

D401,790 S 12/1998 Buell

D489,200 S 5/2004 Antonioni

D538,068 S * 3/2007 Newhouse et al. D6/484

* cited by examiner

Primary Examiner—Janice E Seeger

(74) *Attorney, Agent, or Firm*—Stetina Brunda Garred &
Brucker

(57) **CLAIM**

The ornamental design for a desk, as shown and described.

DESCRIPTION

FIG. 1 is a front perspective view of the desk of the present inventions showing my new designs;

FIG. 2 is a rear perspective view thereof;

FIG. 3 is a top plan view thereof;

FIG. 4 is a front elevational view thereof;

FIG. 5 is a bottom plan view thereof;

FIG. 6 is an end elevational view thereof; and,

FIG. 7 is a rear elevational view thereof.

1 Claim, 3 Drawing Sheets

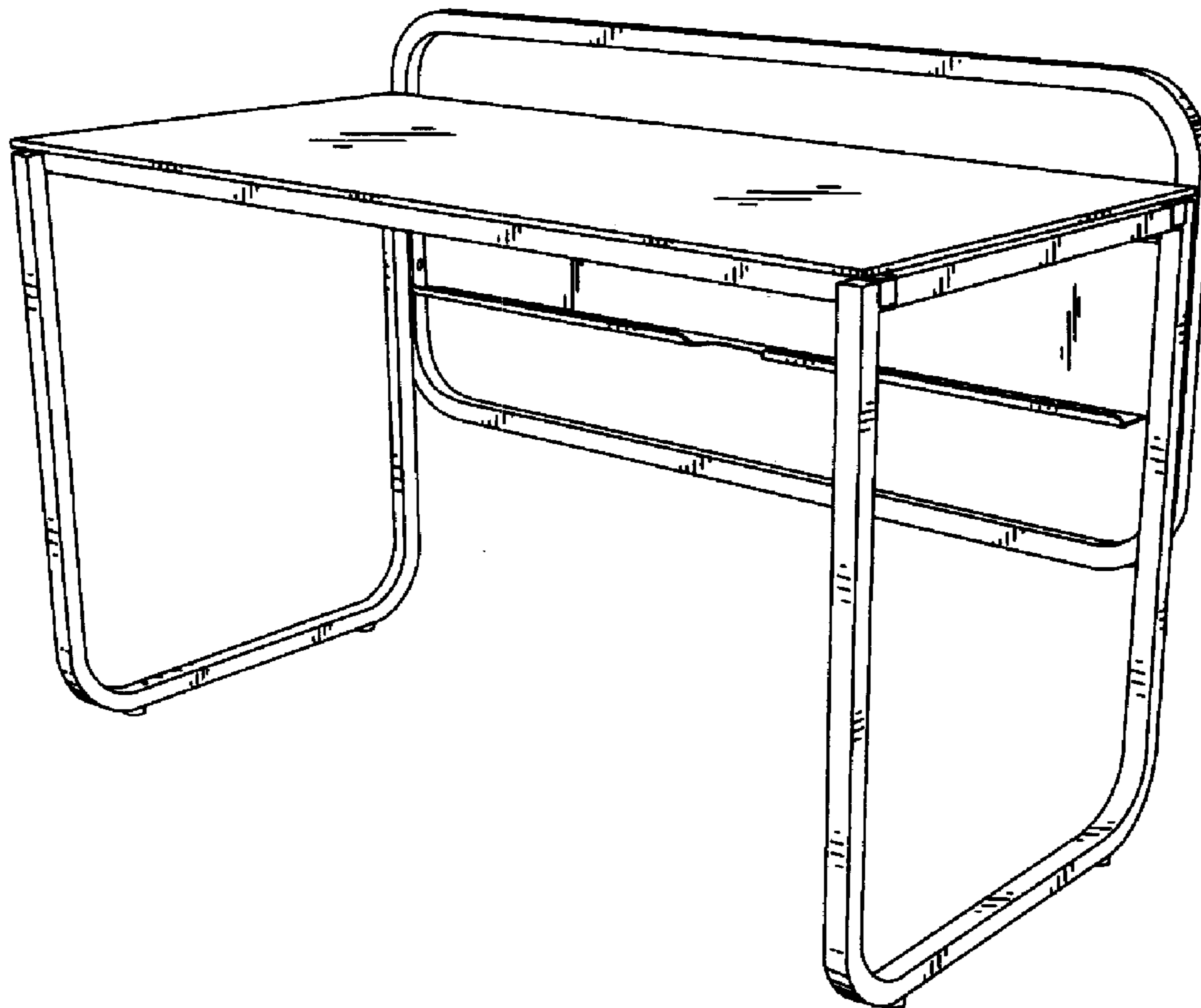

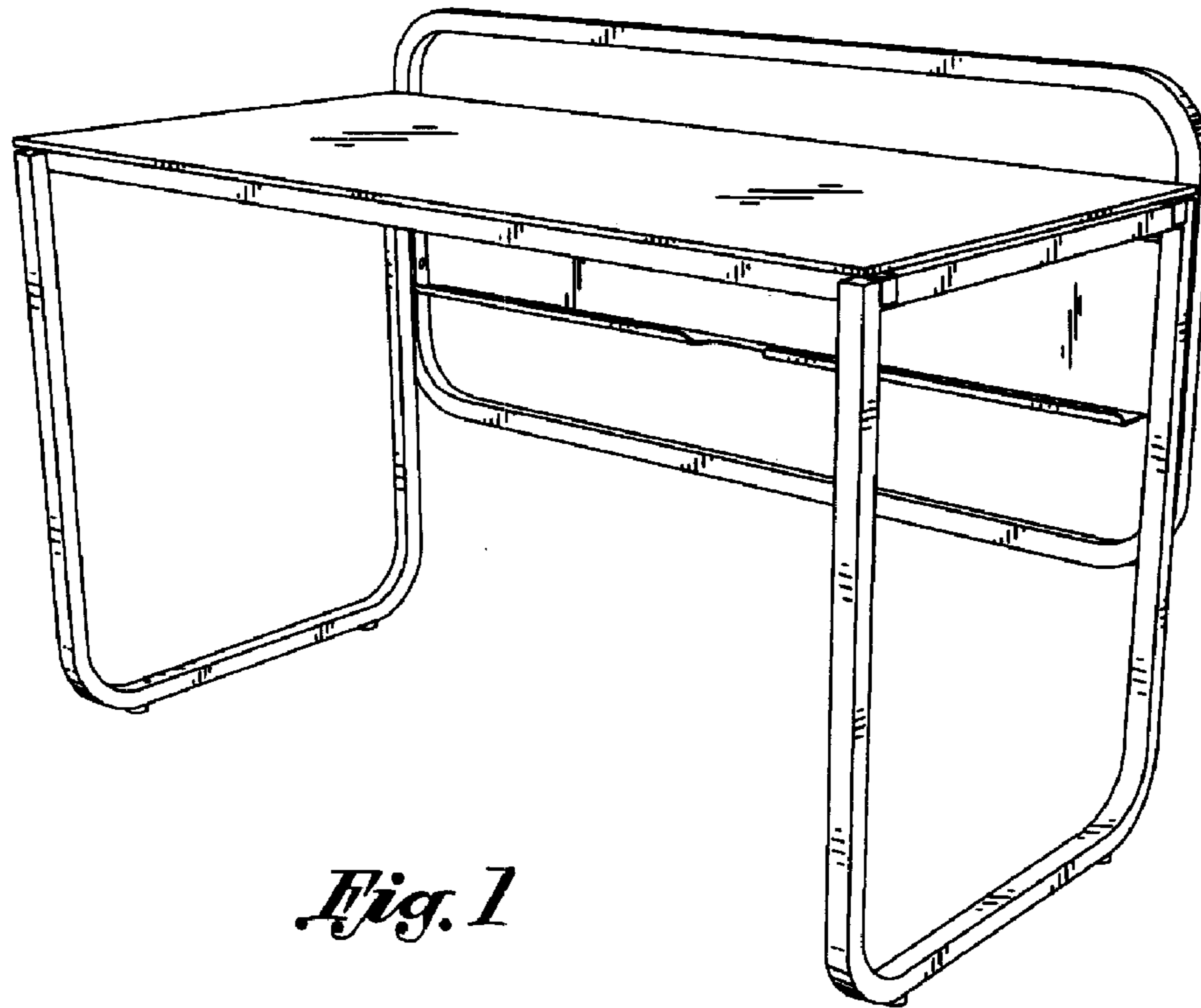

Fig. 1

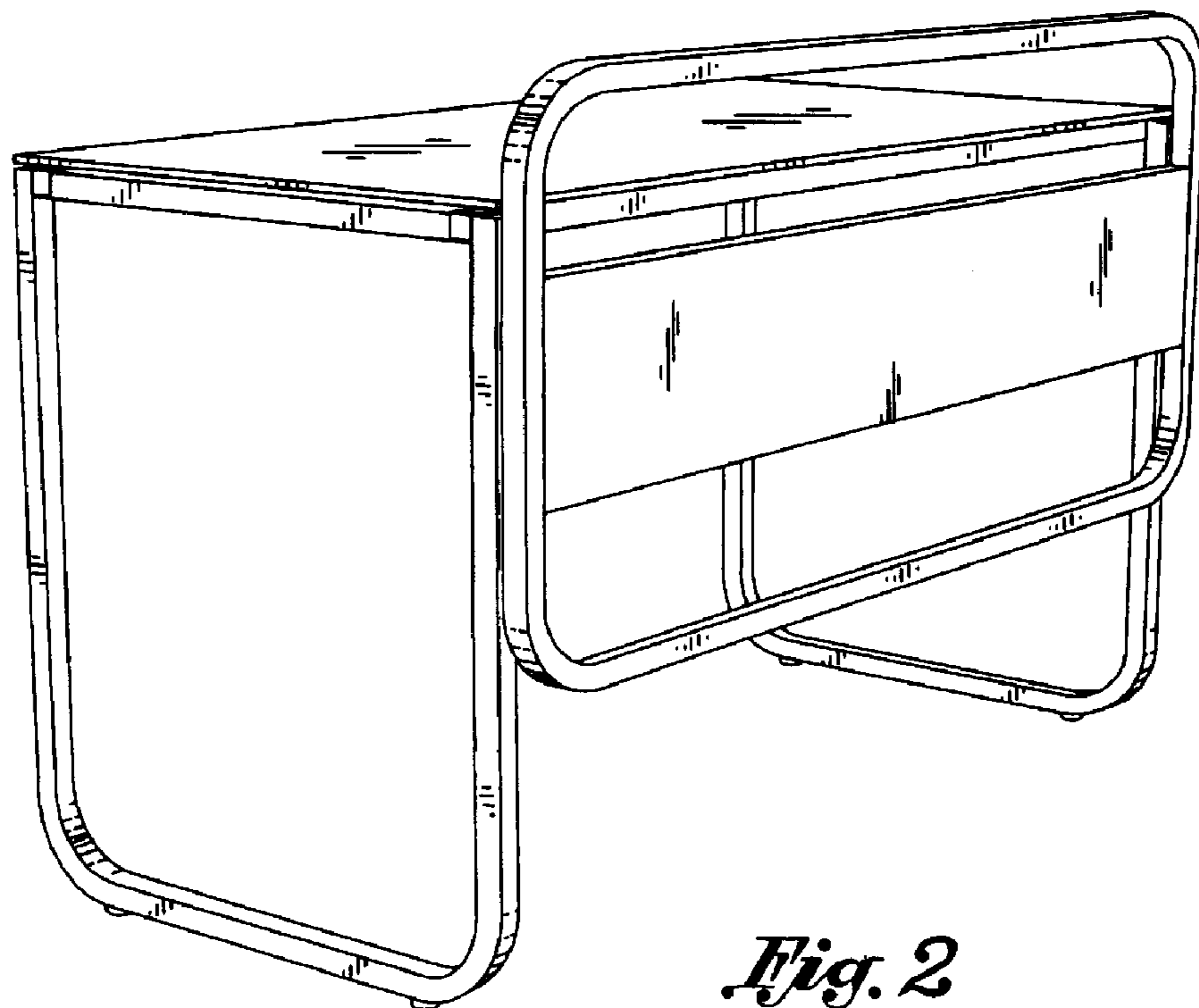

Fig. 2

Fig. 3

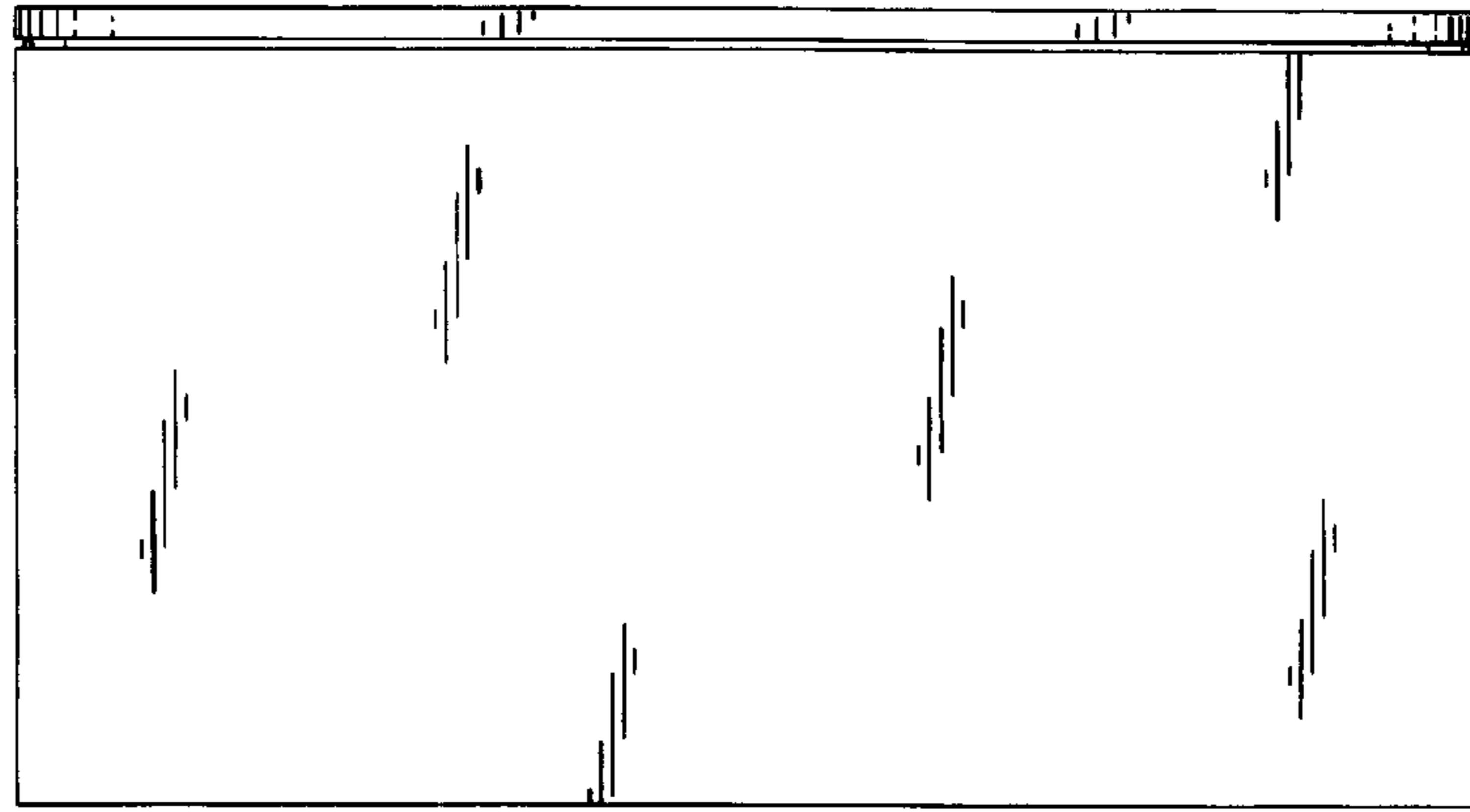

Fig. 4

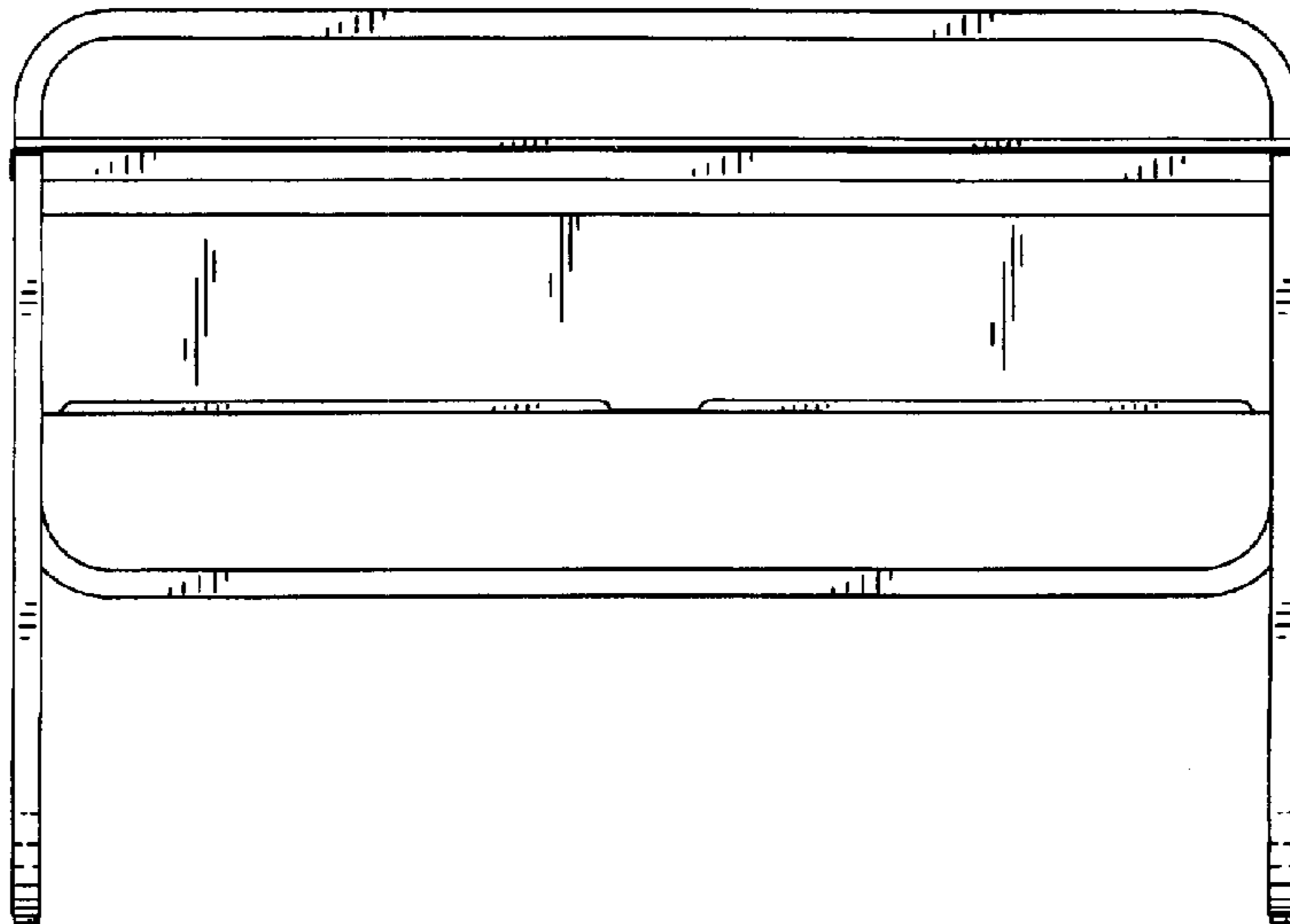
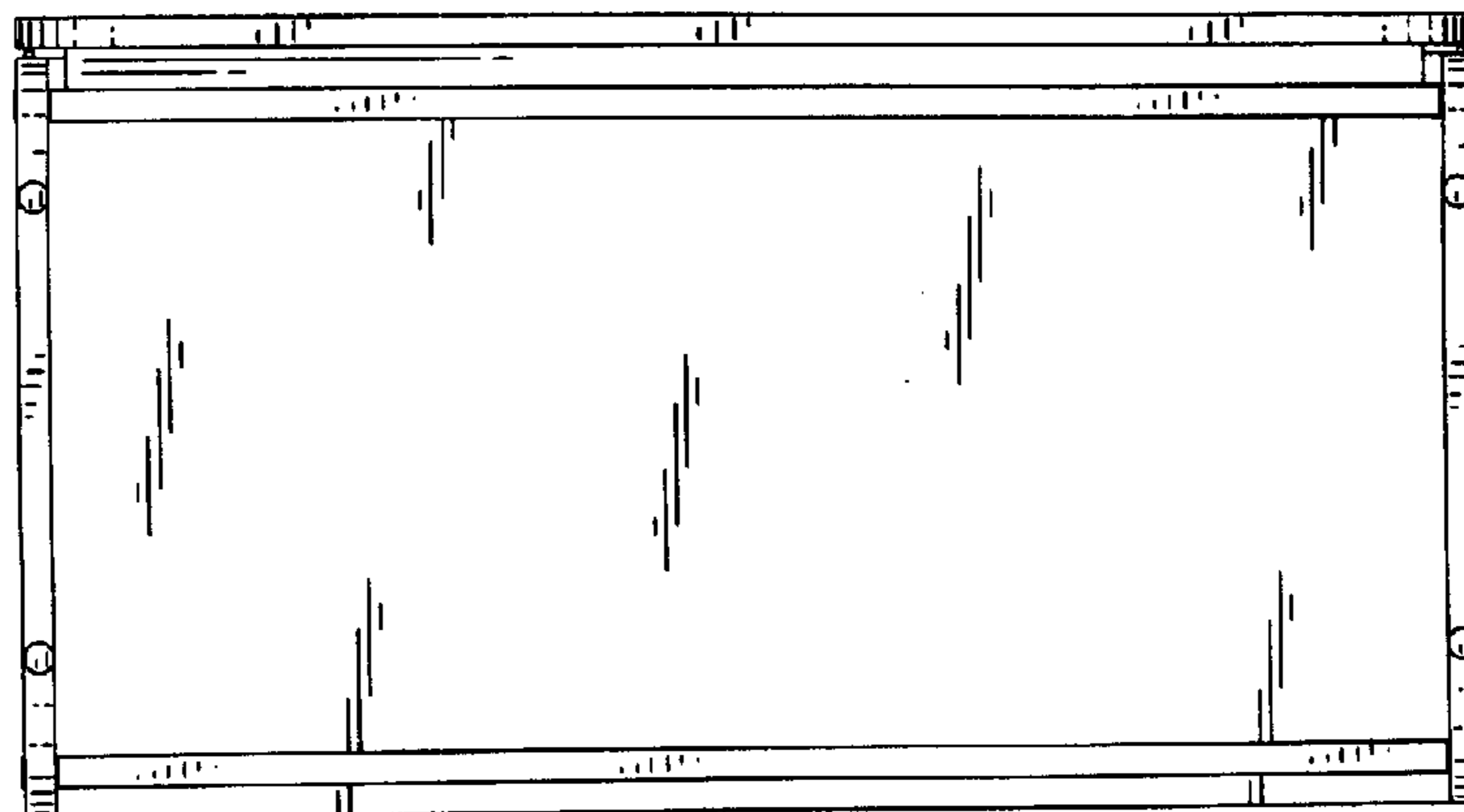

Fig. 5



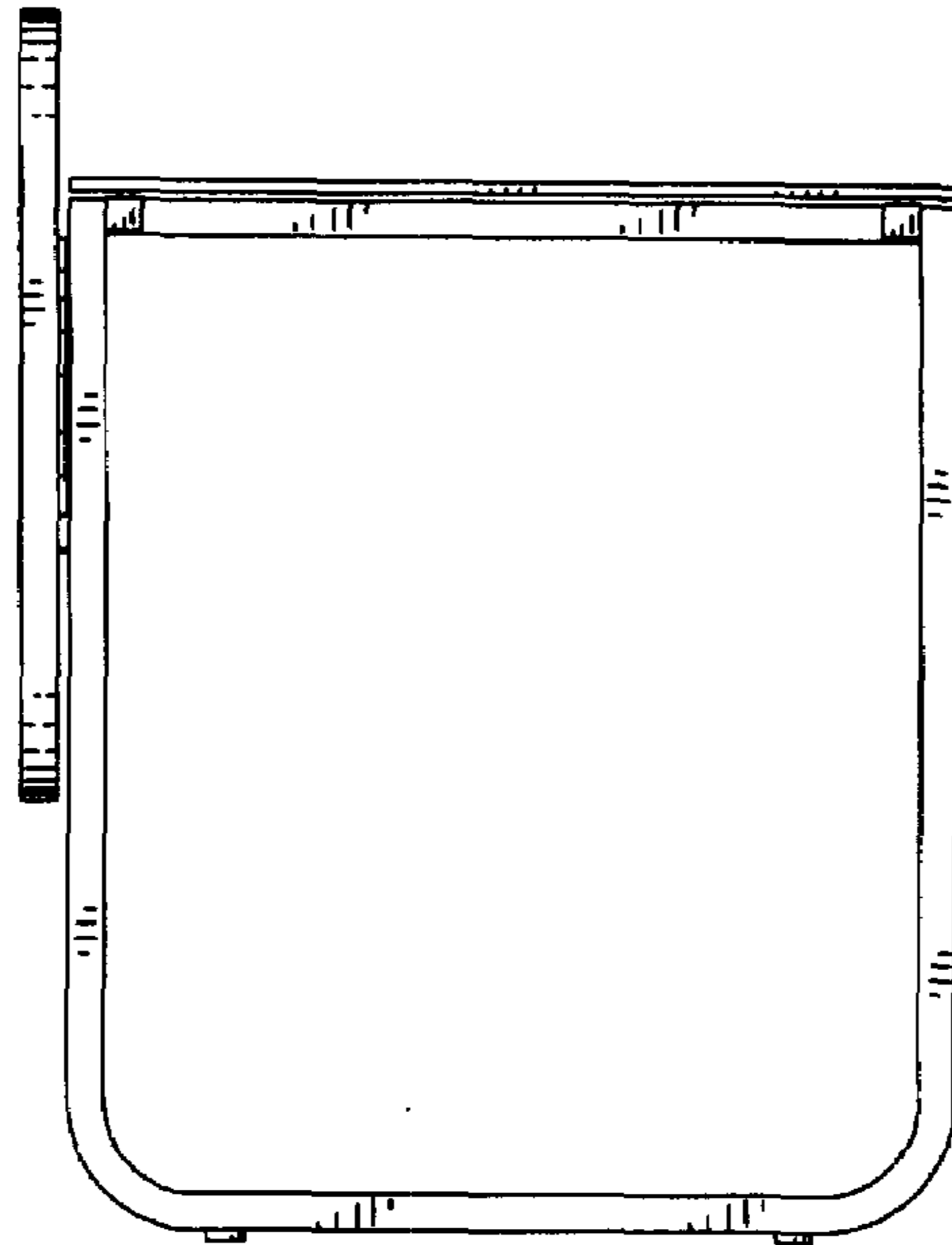

Fig. 6

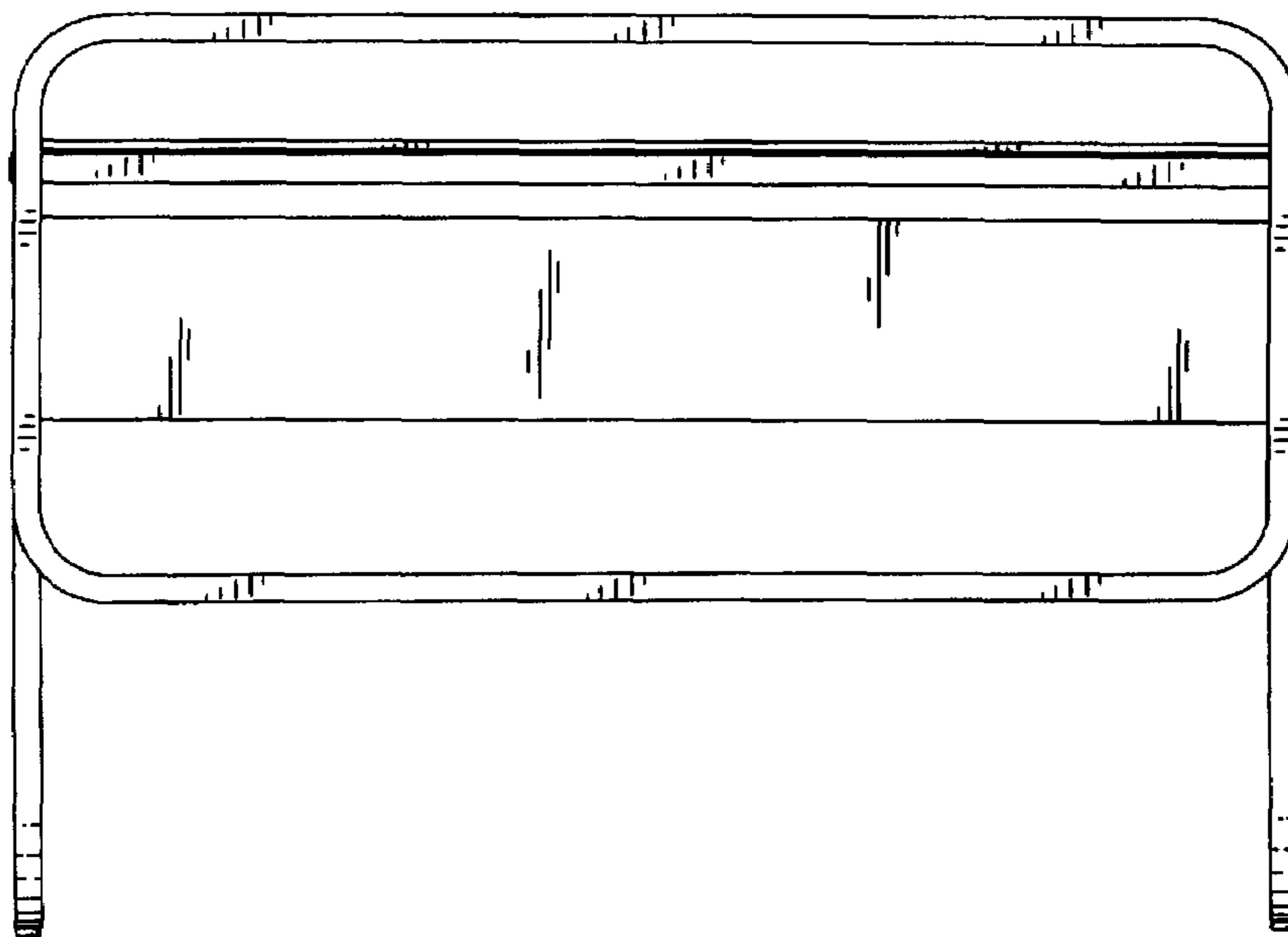

Fig. 7