



US00D603523S

(12) **United States Design Patent**
Nan et al.

(10) **Patent No.:** **US D603,523 S**

(45) **Date of Patent:** **** Nov. 3, 2009**

(54) **VIBRATOR**

D536,458 S * 2/2007 Nan D24/215

(75) Inventors: **Simon Siu Man Nan**, Ontario (CA);
Michel Millot, Ivry sur Seine (FR)

(73) Assignee: **Nanma Manufacturing Co., Ltd.**, Hong
Kong (HK)

(**) Term: **14 Years**

(21) Appl. No.: **29/336,720**

(22) Filed: **May 7, 2009**

(51) **LOC (9) Cl.** **28-03**

(52) **U.S. Cl.** **D24/215**

(58) **Field of Classification Search** D24/200,
D24/214, 211, 215; 600/38, 39; 601/46,
601/101, 87, 84, 80, 70, 67, 78, 85
See application file for complete search history.

(56) **References Cited**

U.S. PATENT DOCUMENTS

D384,156 S *	9/1997	Kain	D24/200
D515,219 S *	2/2006	Nan	D24/215
D515,704 S *	2/2006	Nan	D24/215
D527,109 S *	8/2006	Nan	D24/215
D536,097 S *	1/2007	Nan	D24/215

OTHER PUBLICATIONS

Krystal Wabbit Vibrator. http://images.allegrocentral.com/43/6A/Krystal-Wabbit-Vibrator-216704-prodct-medium_image.jpg.
Accessed Jul. 15, 2009.*

* cited by examiner

Primary Examiner—Cathron C Brooks

Assistant Examiner—Melanie Levy

(74) *Attorney, Agent, or Firm*—Polsinelli Shughart PC

(57) **CLAIM**

The ornamental design for a vibrator, as shown and described.

DESCRIPTION

FIG. 1 is a perspective view of the vibrator, showing my design;

FIG. 2 is a front view of the vibrator;

FIG. 3 is an opposing rear side view of the vibrator;

FIG. 4 is a left side view of the vibrator;

FIG. 5 is an opposing right side view of the vibrator;

FIG. 6 is a top view of the vibrator; and,

FIG. 7 is an opposing bottom view of the vibrator.

1 Claim, 2 Drawing Sheets

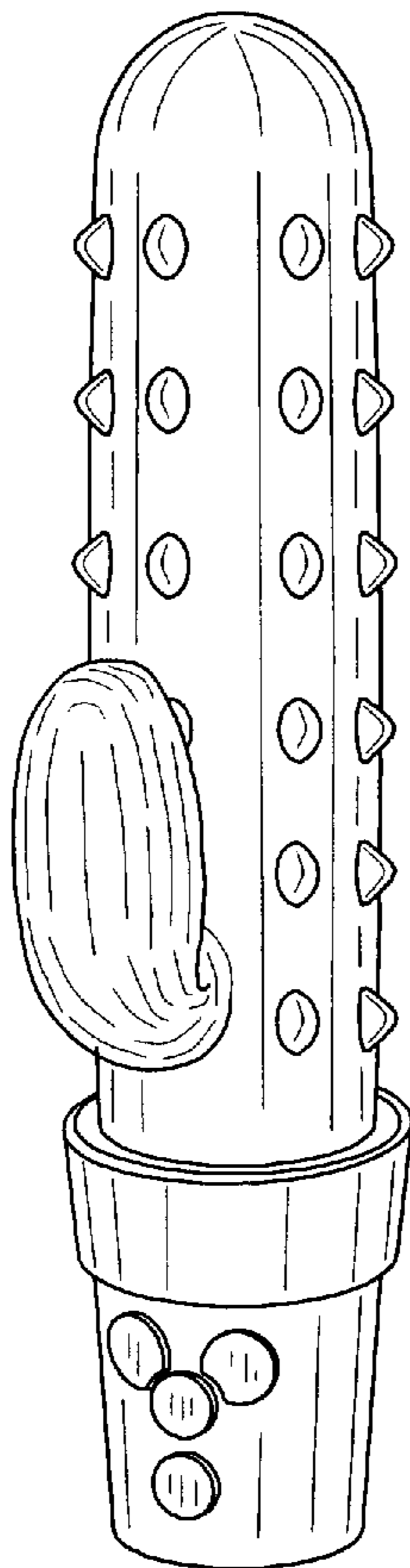

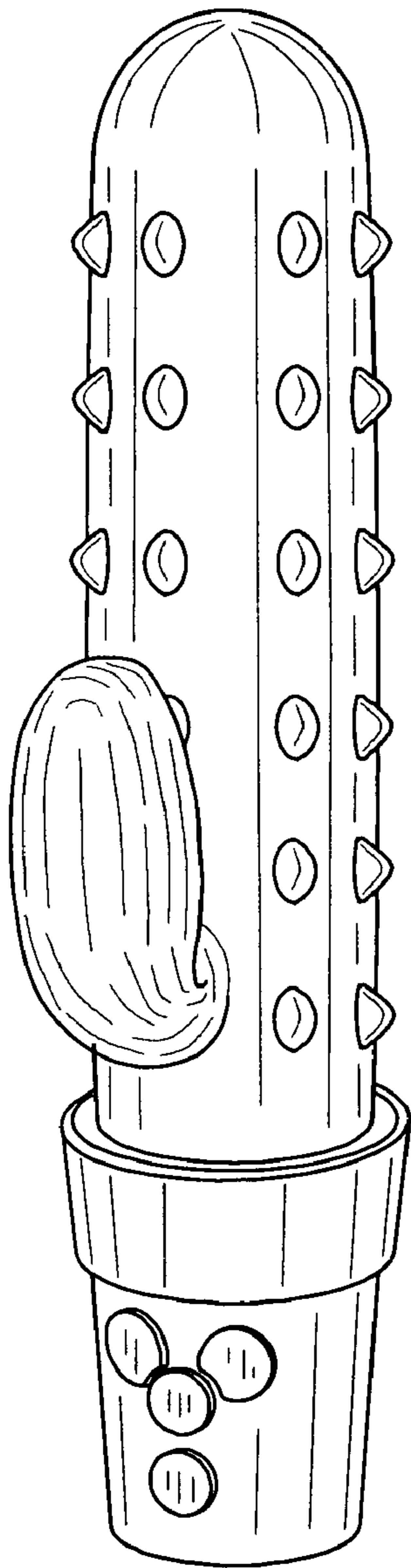

FIG. 1

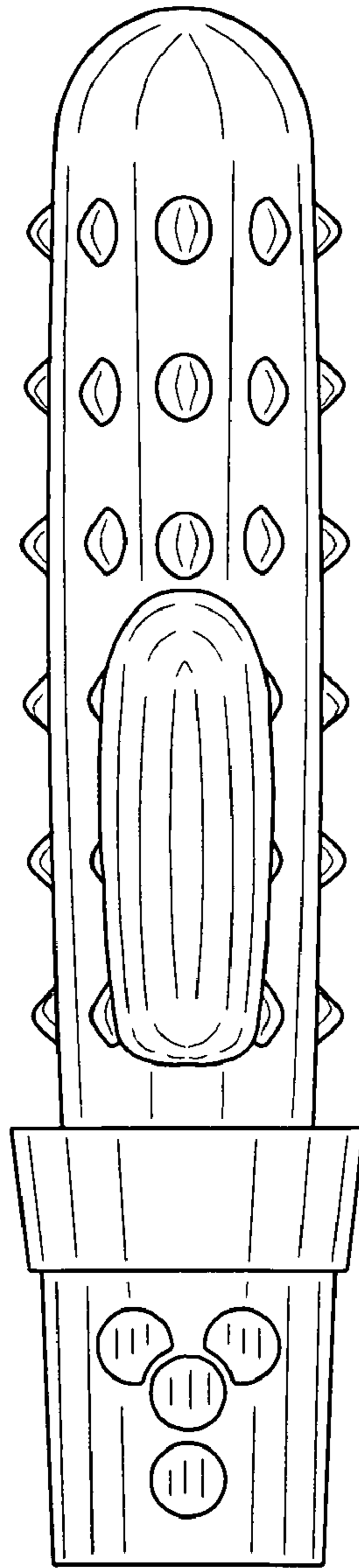

FIG. 2

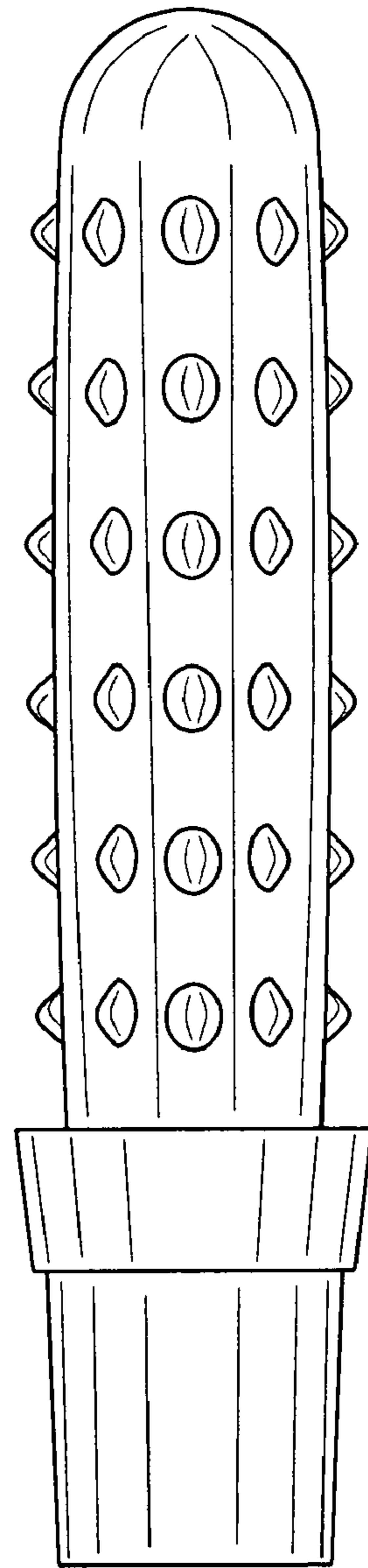

FIG. 3

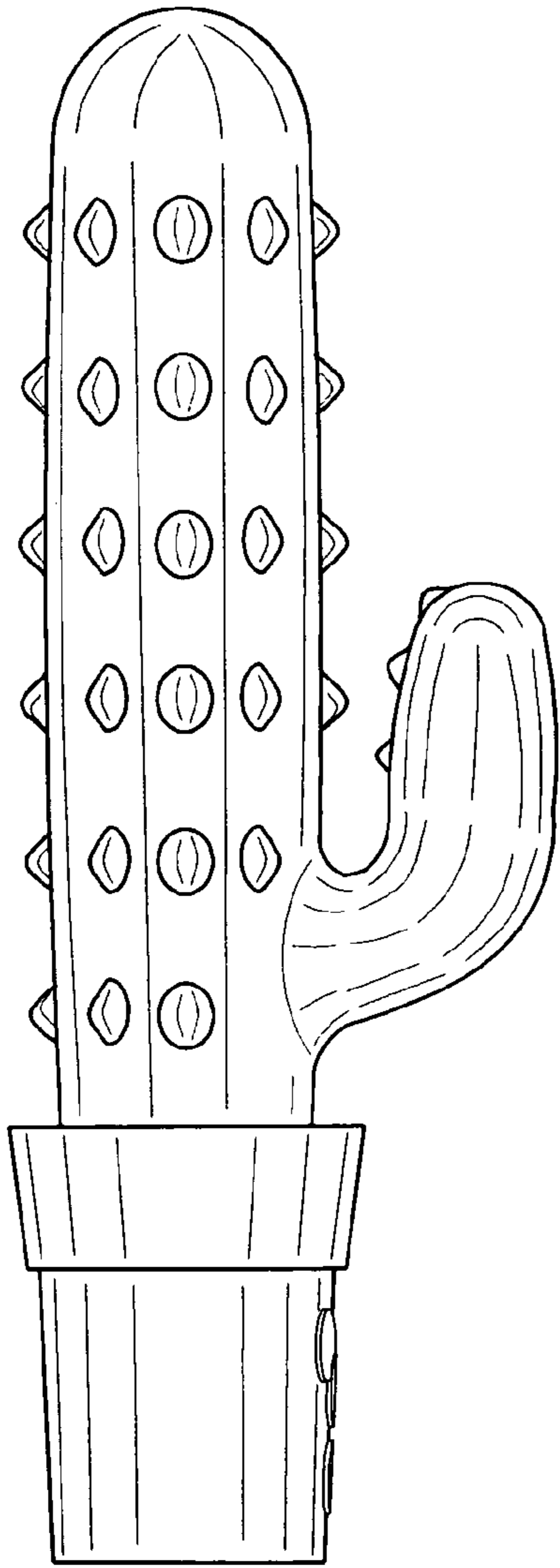

FIG. 4

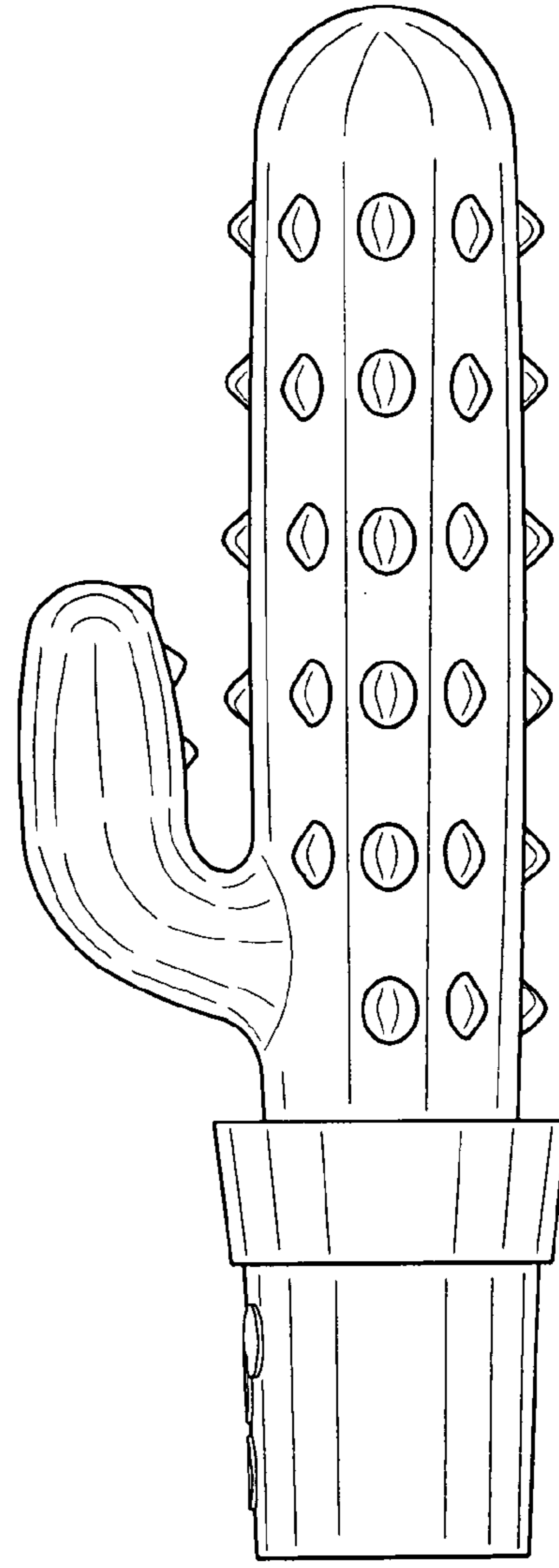

FIG. 5

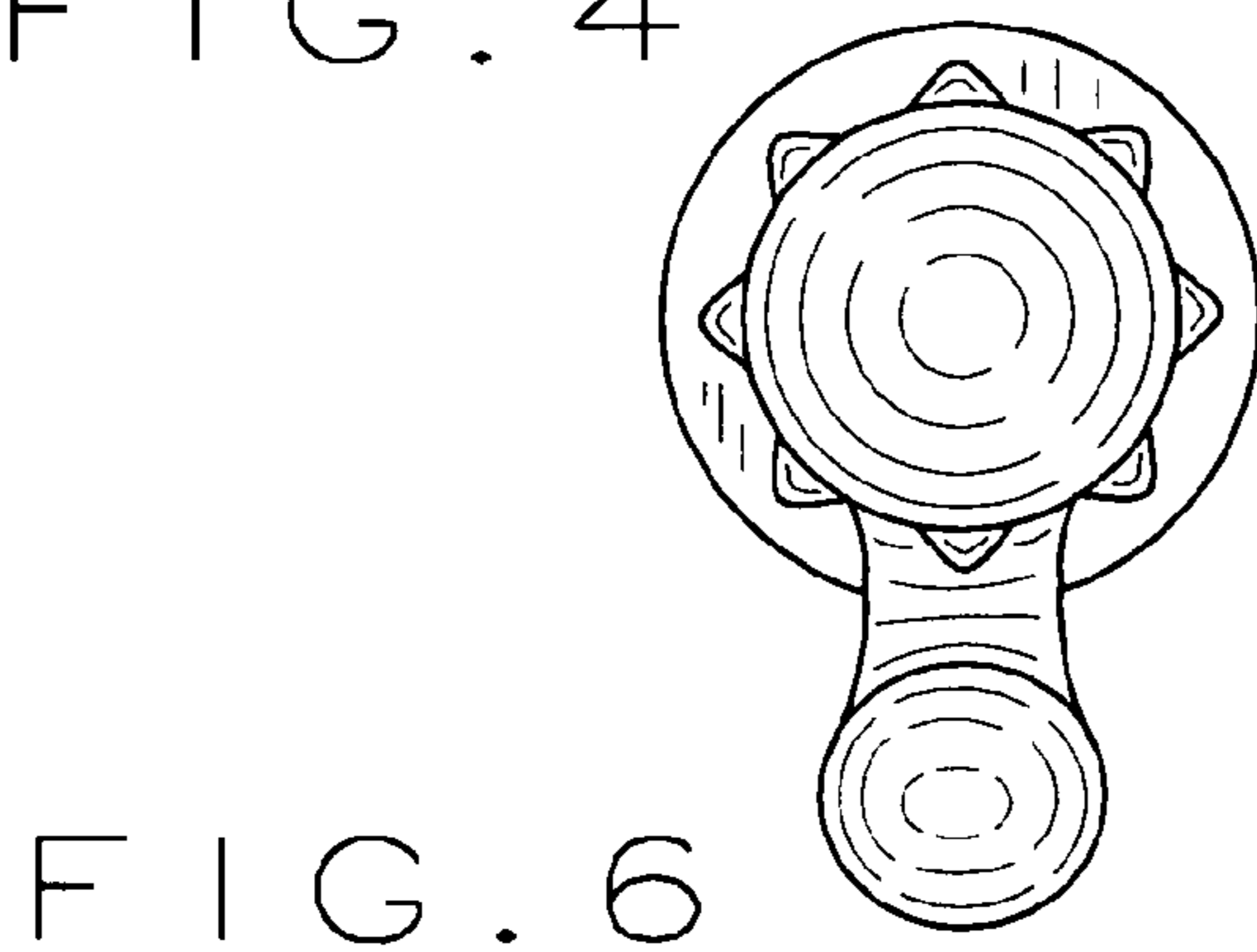

FIG. 6

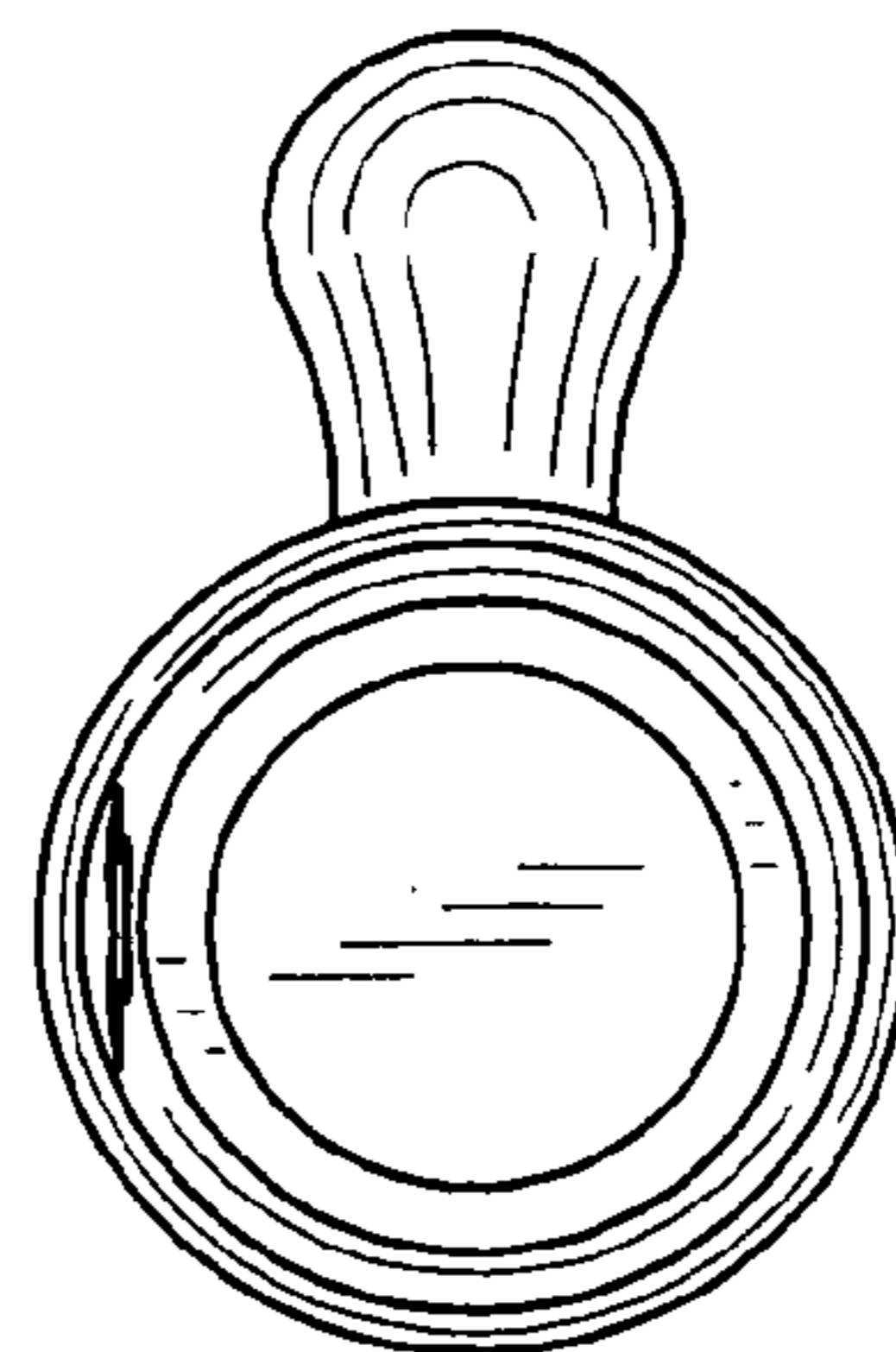

FIG. 7