



US00D603363S

(12) **United States Design Patent**
Choi et al.

(10) **Patent No.:** **US D603,363 S**

(45) **Date of Patent:** **** Nov. 3, 2009**

(54) **MOBILE PHONE**

(75) Inventors: **Jung-Hyun Choi**, Seoul (KR);
Seung-Min Park, Seoul (KR);
Seog-Guen Kim, Seoul (KR)

(73) Assignee: **Samsung Electronics, Ltd.**, Suwon-Si (KR)

(**) Term: **14 Years**

(21) Appl. No.: **29/328,497**

(22) Filed: **Nov. 25, 2008**

(30) **Foreign Application Priority Data**

Aug. 18, 2008 (KR) 30-2008-0035621

(51) **LOC (9) Cl.** **14-03**

(52) **U.S. Cl.** **D14/138 AB; D21/330**

(58) **Field of Classification Search** D14/138 AB,
D14/496, 345, 346, 203.3, 203.4, 203.7, 138 AD,
D14/327; 455/575.3; D21/329-331

See application file for complete search history.

(56) **References Cited**

U.S. PATENT DOCUMENTS

D275,971	S *	10/1984	Yokoi	D21/330
D390,541	S *	2/1998	Chiba	D14/345
D391,987	S *	3/1998	Jambhekar et al.	D14/345
5,896,575	A *	4/1999	Higginbotham et al.	455/566
D424,537	S *	5/2000	Arai et al.	D14/318
D445,787	S *	7/2001	Francis	D14/345
D491,934	S *	6/2004	Shimano et al.	D14/318
D494,968	S *	8/2004	Yonekawa et al.	D14/345
D524,870	S *	7/2006	Sugino et al.	D21/330
D532,051	S *	11/2006	Sugino et al.	D21/330
D537,064	S *	2/2007	Kim et al.	D14/138 AA
7,181,256	B2 *	2/2007	Hyun et al.	455/575.3
D547,295	S *	7/2007	Park	D14/138 AB
D554,194	S *	10/2007	Ehara et al.	D21/330
D557,674	S *	12/2007	Lee et al.	D14/138 AB
D558,719	S *	1/2008	Choi et al.	D14/138 AA
D560,194	S *	1/2008	Song et al.	D14/138 AB
D563,371	S *	3/2008	Kim et al.	D14/138 AA

D567,207	S *	4/2008	Kim et al.	D14/138 AB
D577,018	S *	9/2008	Lin	D14/346
D591,254	S *	4/2009	Lim et al.	D14/138 AA
D591,255	S *	4/2009	Lee et al.	D14/138 AA
D592,211	S *	5/2009	Ichise et al.	D14/346
D593,987	S *	6/2009	Lin	D14/138 AB
2006/0135225	A1 *	6/2006	Lin et al.	455/575.3
2007/0072657	A1 *	3/2007	Hyun et al.	455/575.3

OTHER PUBLICATIONS

Toshiba G910/G920 telephone, announced Jan. 2008, [online], [site visited Jun. 16, 2009]. Available from Internet ,<URL: <http://www.gsmarena.com>>.*

LG KT610 telephone, announced Feb. 2008, [online], [site visited Jun. 16, 2009]. Available from Internet ,<URL: <http://www.gsmarena.com>>.*

i-mate JASJAR telephone, announced Aug. 2005, [online], [site visited Jun. 16, 2009]. Available from Internet ,<URL: <http://www.gsmarena.com>>.*

* cited by examiner

Primary Examiner—Jeffrey D Asch

(74) *Attorney, Agent, or Firm*—Staas & Halsey LLP

(57) **CLAIM**

The ornamental design for a mobile phone, as shown and described.

DESCRIPTION

FIG. 1 is a front perspective view of a mobile phone;
FIG. 2 is a front view of the mobile phone of FIG. 1;
FIG. 3 is a rear view of the mobile phone of FIG. 1;
FIG. 4 is a left-side view of the mobile phone of FIG. 1;
FIG. 5 is a right-side view of the mobile phone of FIG. 1;
FIG. 6 is a top plan view of the mobile phone of FIG. 1;
FIG. 7 is a bottom plan view of the mobile phone of FIG. 1;
FIG. 8 is an open view of the mobile phone of FIG. 1; and,
FIG. 9 is an open perspective view of the portable phone of FIG. 1.

1 Claim, 6 Drawing Sheets

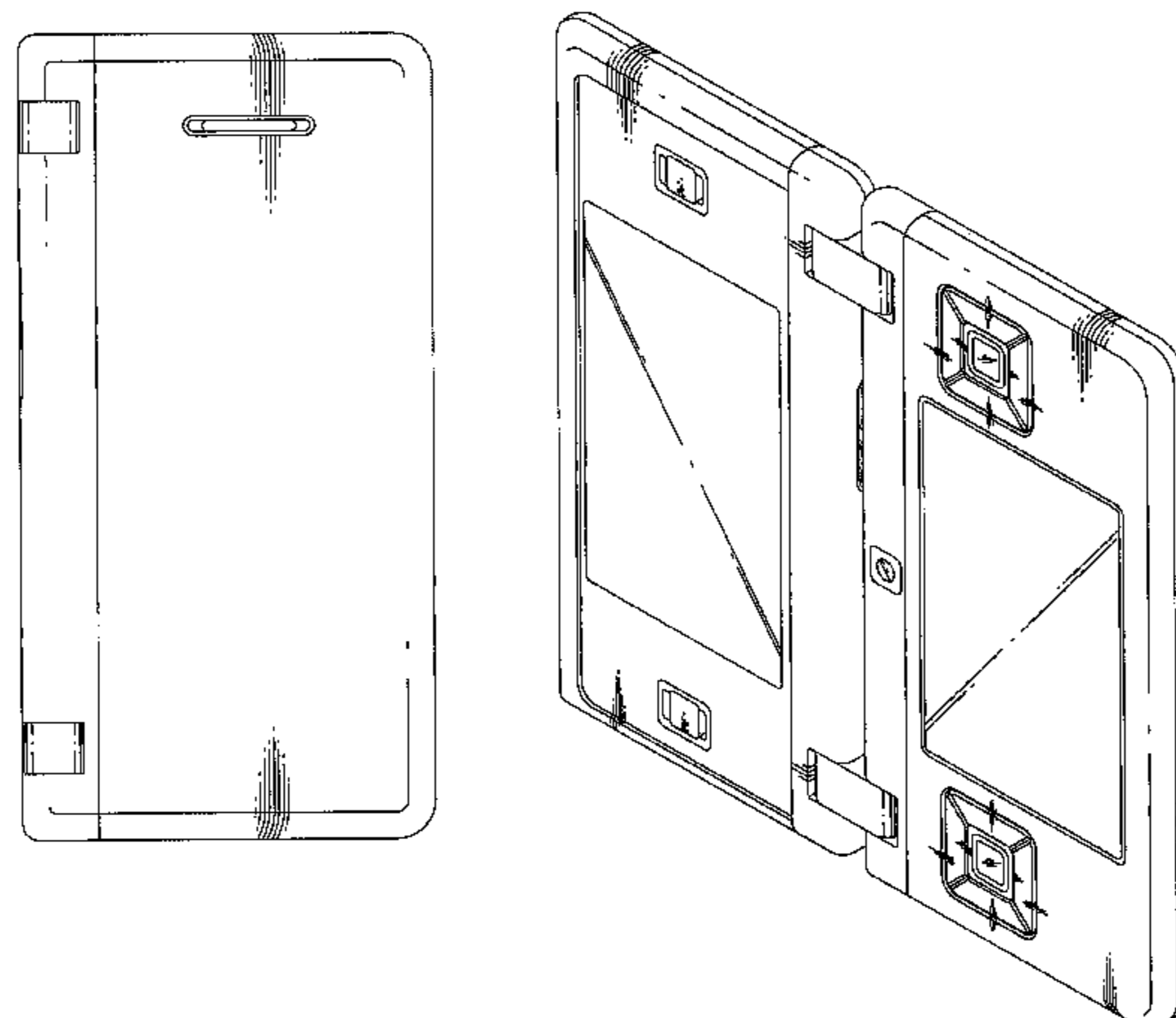

FIG. 1

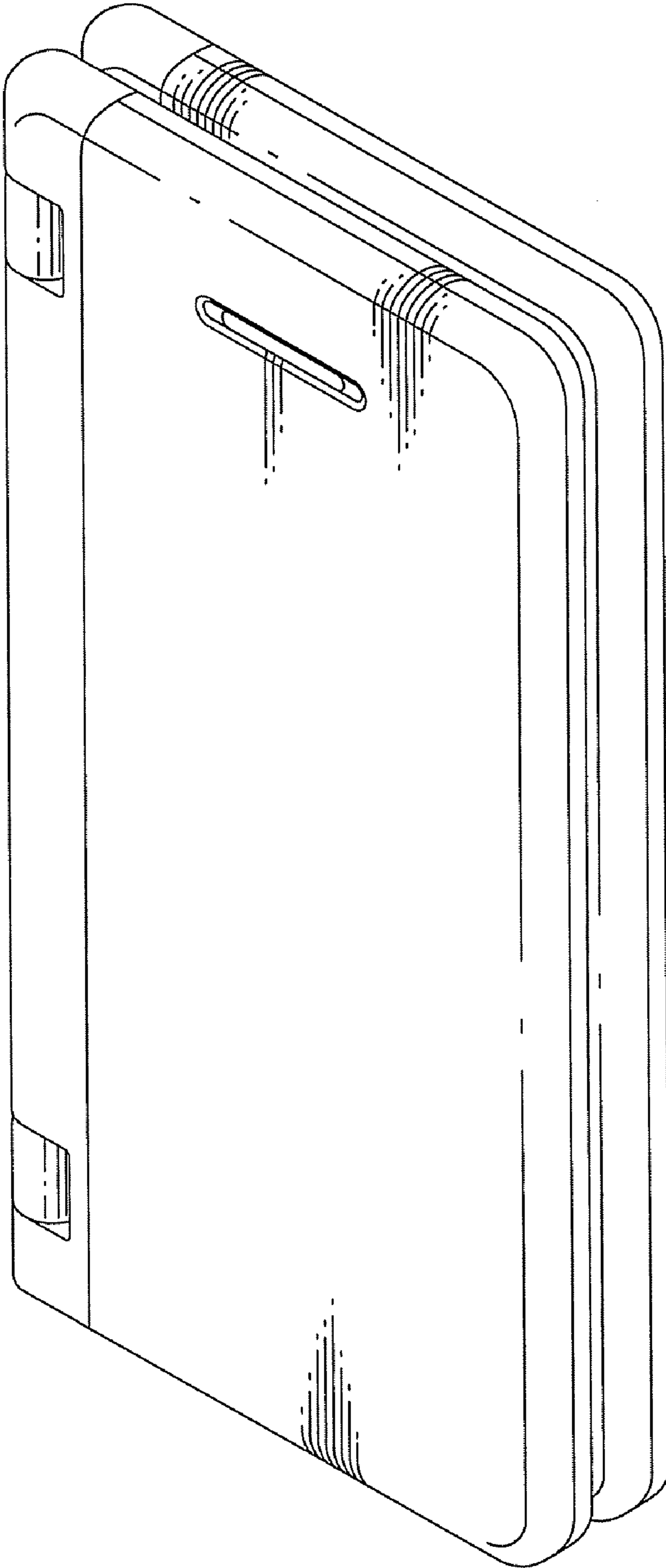

FIG. 2

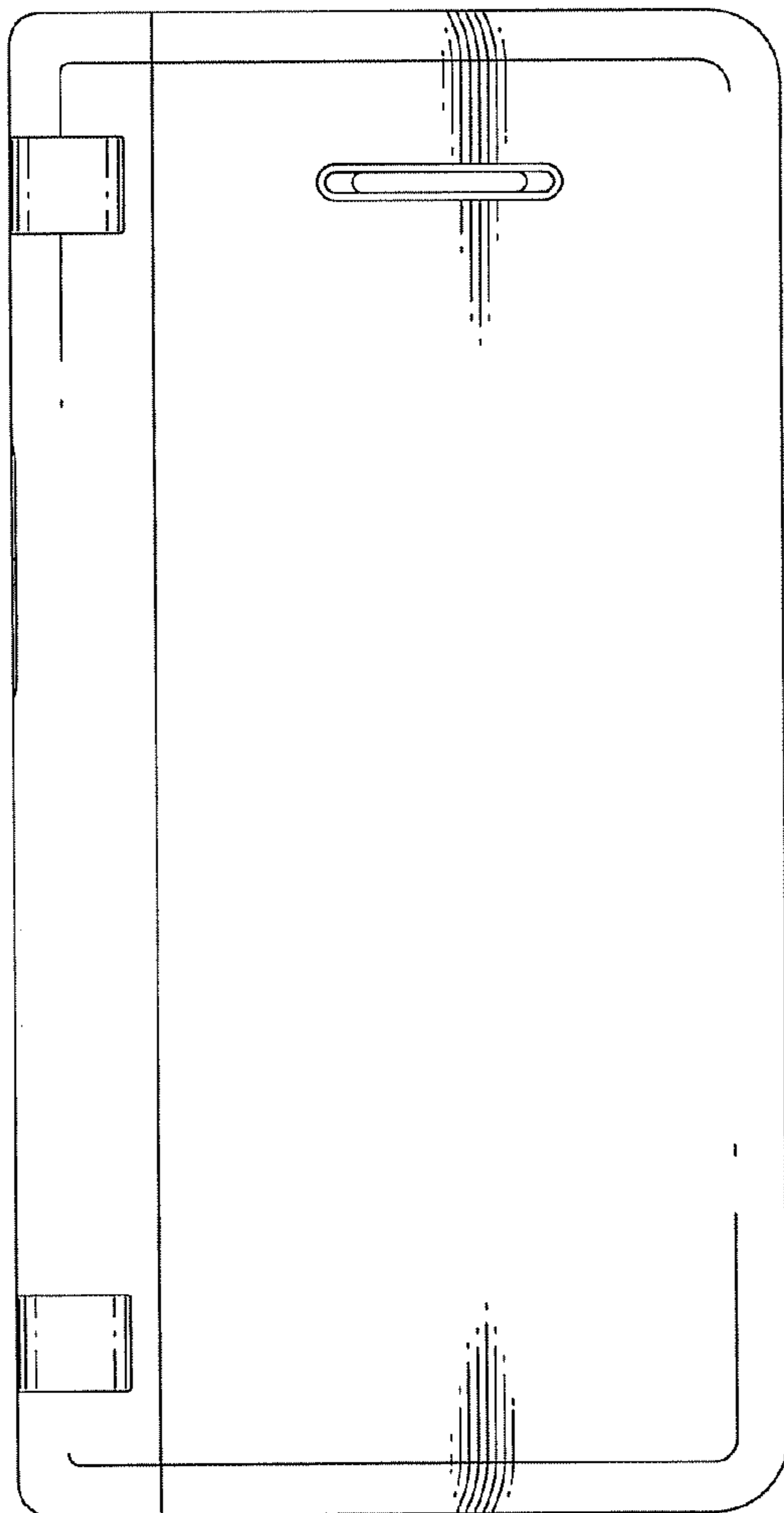

FIG. 3

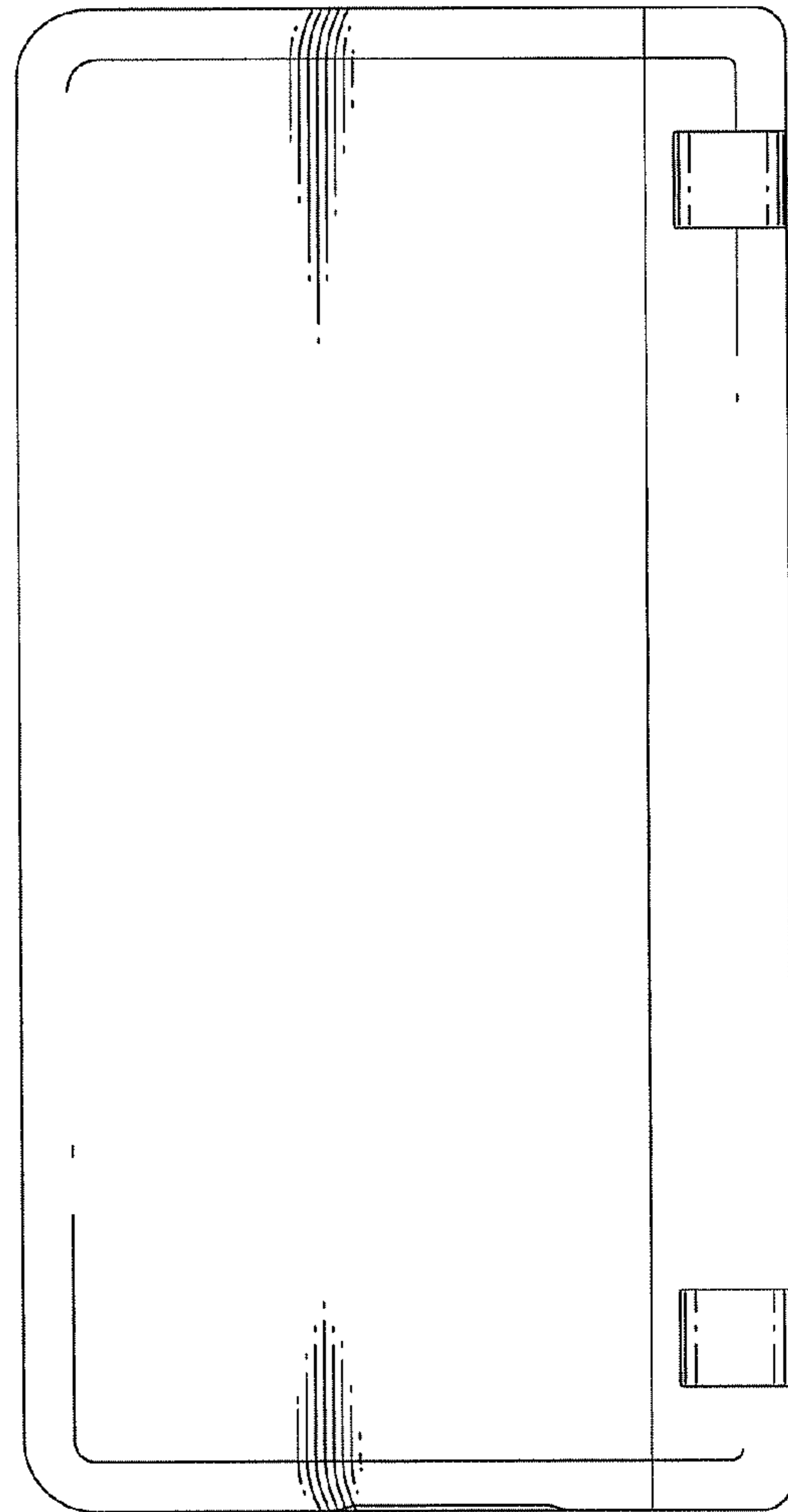

FIG. 4

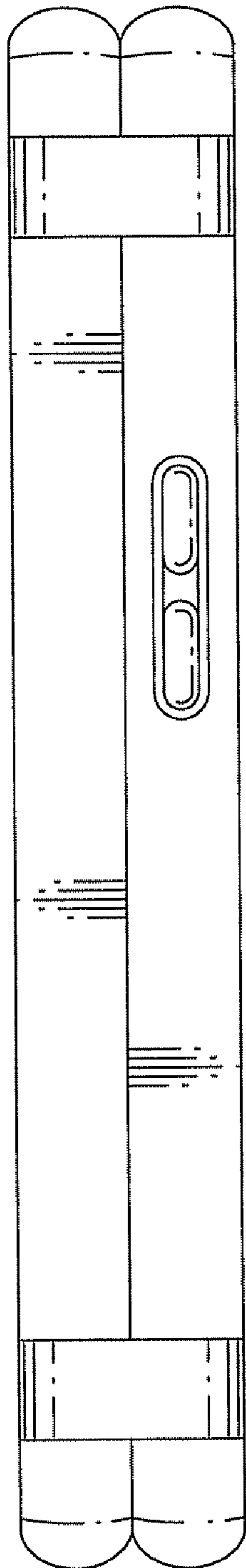

FIG. 5

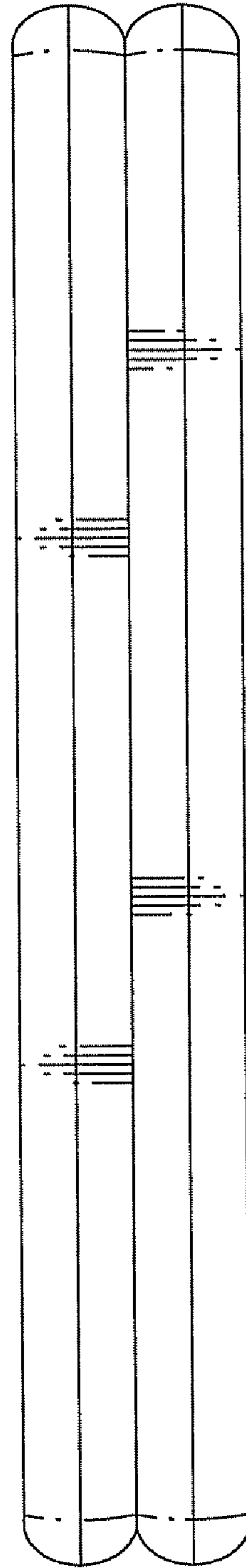

FIG. 6

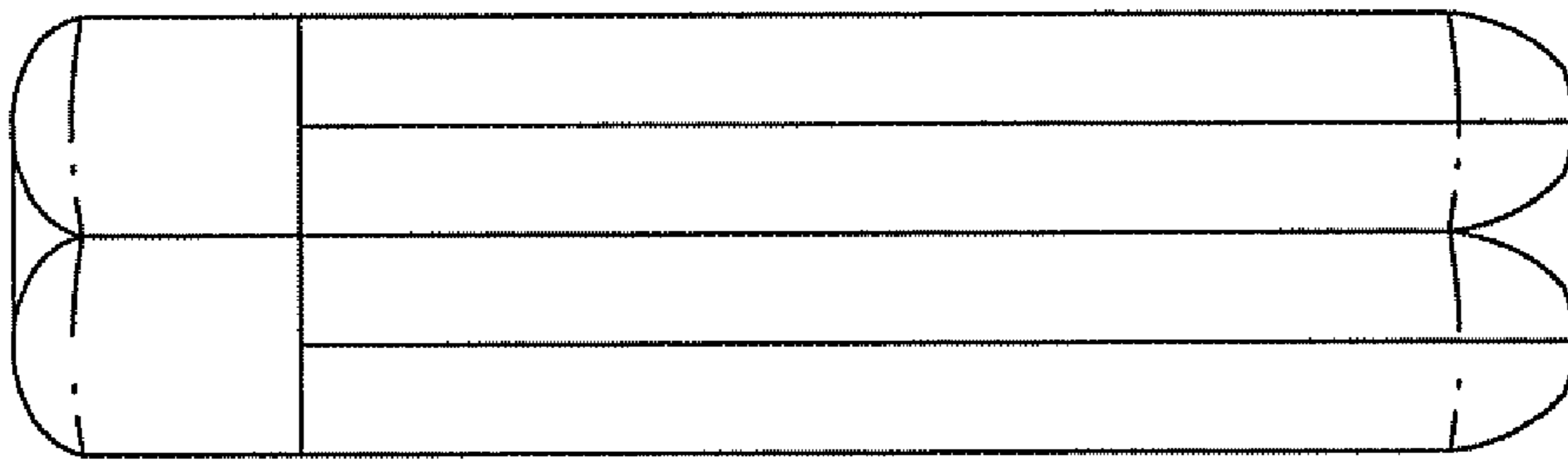

FIG. 7

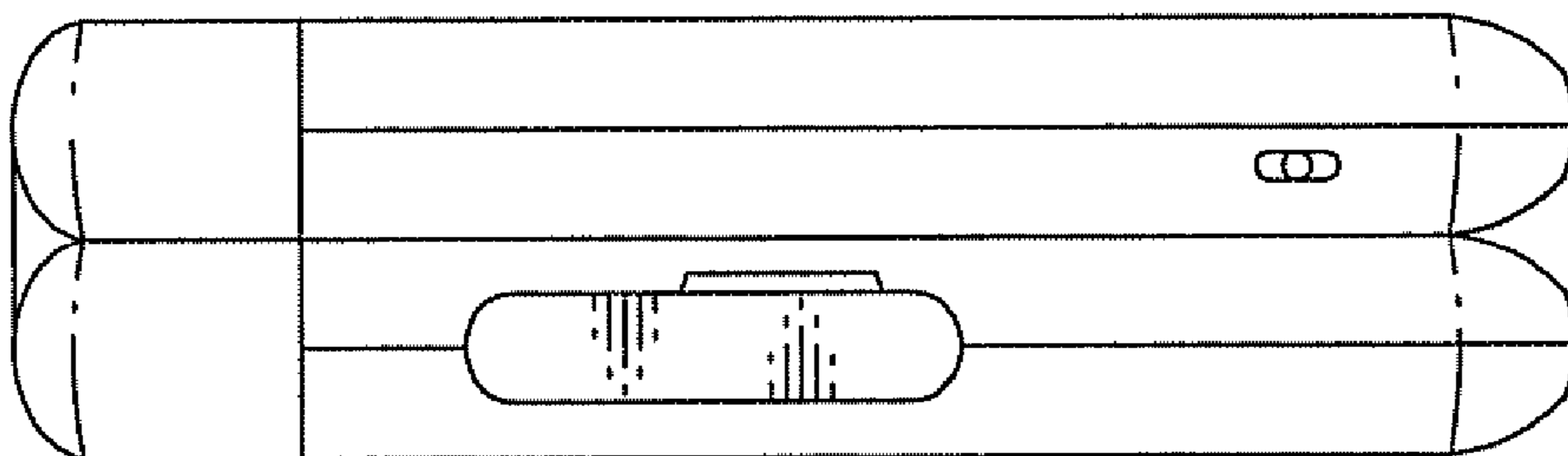

FIG. 8

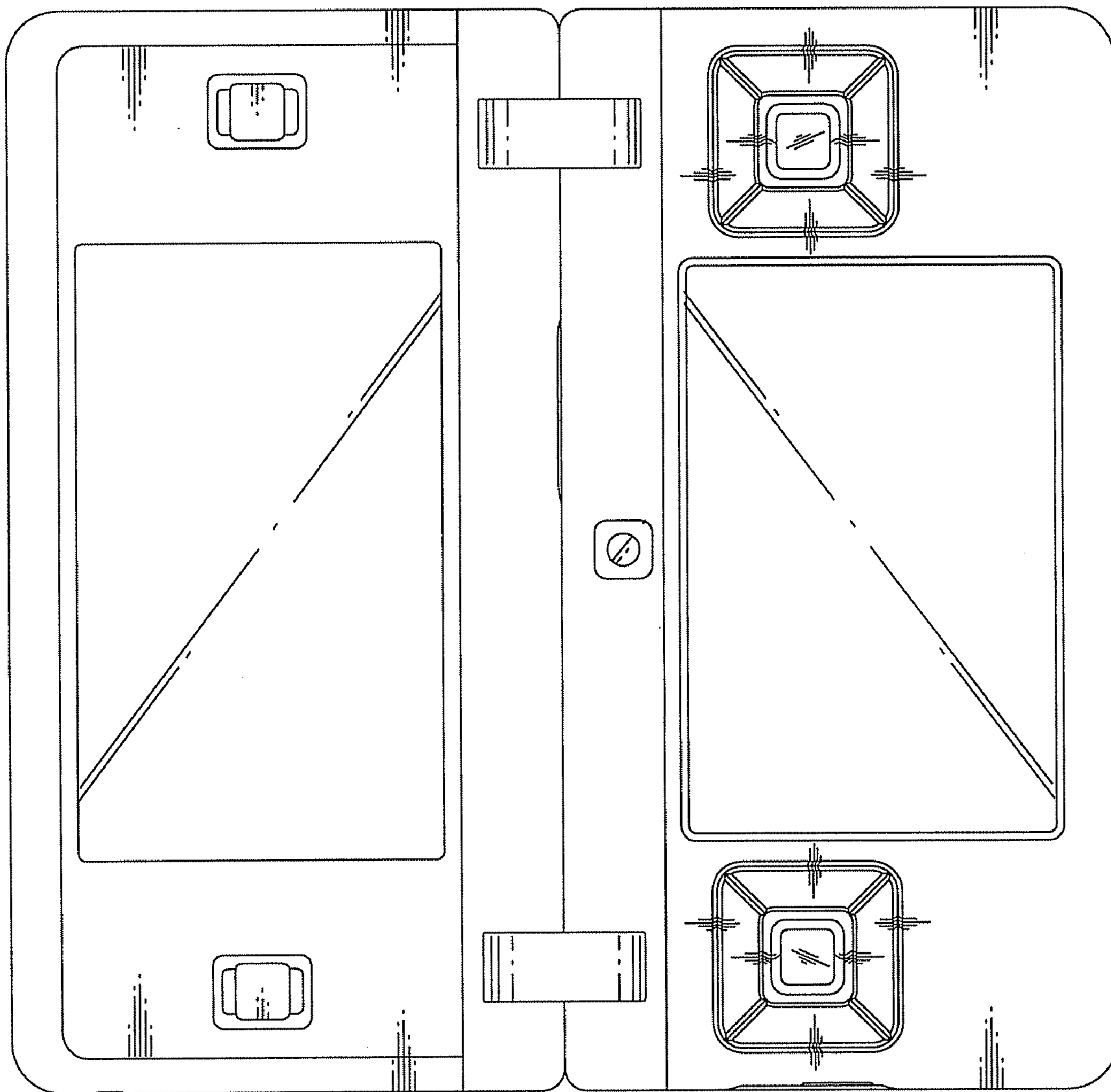

FIG. 9

