



US00D603361S

(12) **United States Design Patent**
Kang

(10) **Patent No.:** **US D603,361 S**
(45) **Date of Patent:** **** Nov. 3, 2009**

(54) **MOBILE PHONE**

D584,269 S * 1/2009 Baik et al. D14/138 AA
(Continued)

(75) Inventor: **Simon Kang**, Los Angeles, CA (US)

(73) Assignee: **Samsung Electronics Co., Ltd.**,
Suwon-Si (KR)

(**) Term: **14 Years**

(21) Appl. No.: **29/328,185**

(22) Filed: **Nov. 20, 2008**

(30) **Foreign Application Priority Data**

Aug. 21, 2008 (KR) 30-2008-0036118

(51) **LOC (9) Cl.** **14-03**

(52) **U.S. Cl.** **D14/138 AA; D14/138 G;**
D14/138 AD

(58) **Field of Classification Search** **D14/138 R,**
D14/138 AD, 138 AC, 138 C, 138 G, 191,
D14/203.1-203.8, 496, 138 AA, 138 AB,
D14/247-248, 137, 147, 218, 341-347; D10/65,
D10/78, 104; D13/168; D18/7; 455/566,
455/575.1, 575.3

See application file for complete search history.

(56) **References Cited**

U.S. PATENT DOCUMENTS

6,675,028 B1 *	1/2004	Heie	434/113
D496,642 S *	9/2004	Harries et al.	D14/138 AA
D517,039 S *	3/2006	Lee	D14/138 AA
D525,959 S *	8/2006	Kim et al.	D14/138 AD
D541,252 S *	4/2007	Kim et al.	D14/138 AA
D543,188 S *	5/2007	Minamide et al.	D14/138 AA
D547,743 S *	7/2007	Kim et al.	D14/138 AA
D551,647 S *	9/2007	Kim et al.	D14/138 AD
D560,196 S *	1/2008	Kim et al.	D14/138 AA
D576,991 S *	9/2008	Kim et al.	D14/138 AA
D579,896 S *	11/2008	Kim et al.	D14/138 AD
D579,905 S *	11/2008	Kim et al.	D14/138 AD
D582,880 S *	12/2008	Kim et al.	D14/138 AA

OTHER PUBLICATIONS

LG KF700, announced Feb. 2008, [online], [retrieved on Mar. 21, 2008 & May 14, 2008]. Retrieved from Internet, <URL: <http://www.gsmarena.com>>.*

BenQ P30, announced 1st quarter 2004, [online], [retrieved on Dec. 1, 2006]. Retrieved from Internet, <URL: <http://www.gsmarena.com>>.*

Sagem My X-8, announced 3rd quarter 2004, [online], [retrieved on Dec. 4, 2006]. Retrieved from Internet, <URL: <http://www.gsmarena.com>>.*

VK Mobile VK2200, announced Mar. 2006, [online], [retrieved on Jun. 16, 2009]. Retrieved from Internet, <URL: <http://www.gsmarena.com>>.*

Nokia N82, announced Nov. 2007, [online], [retrieved on Jun. 16, 2009]. Retrieved from Internet, <URL: <http://www.gsmarena.com>>.*

Primary Examiner—Jeffrey D Asch

Assistant Examiner—Bridget L Eland

(74) *Attorney, Agent, or Firm*—Staas & Halsey LLP

(57) **CLAIM**

The ornamental design for a mobile phone, as shown and described.

DESCRIPTION

FIG. 1 is a front perspective view of a mobile phone;
FIG. 2 is a front view of the mobile phone of FIG. 1;
FIG. 3 is a rear view of the mobile phone of FIG. 1;
FIG. 4 is a left-side view of the mobile phone of FIG. 1;
FIG. 5 is a right-side view of the mobile phone of FIG. 1;
FIG. 6 is a top plan view of the mobile phone of FIG. 1;
FIG. 7 is a bottom plan view of the mobile phone of FIG. 1;
and,
FIG. 8 is an open view of the mobile phone where keypad portion is detached from the mobile phone of FIG. 1.

1 Claim, 5 Drawing Sheets

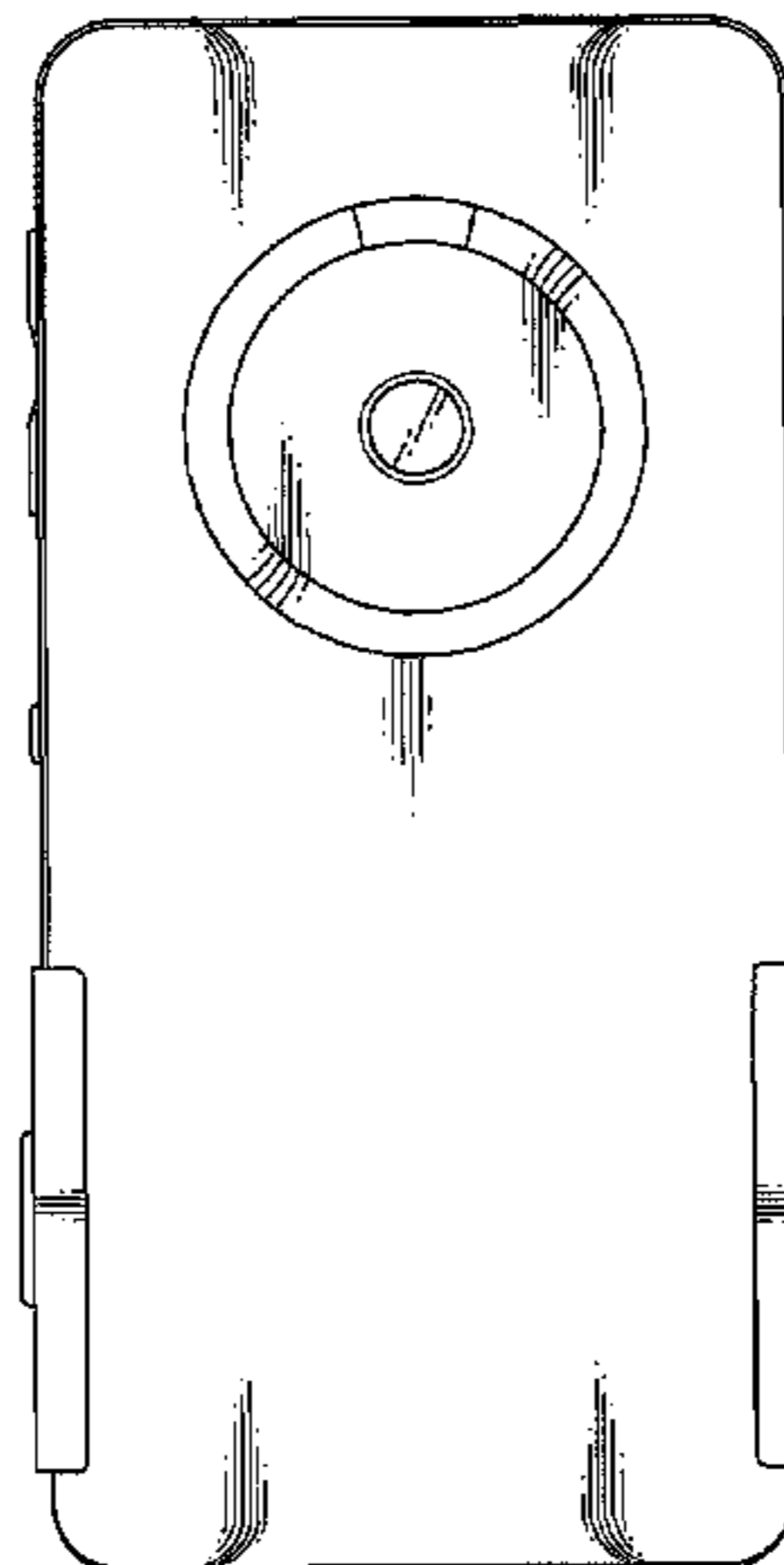
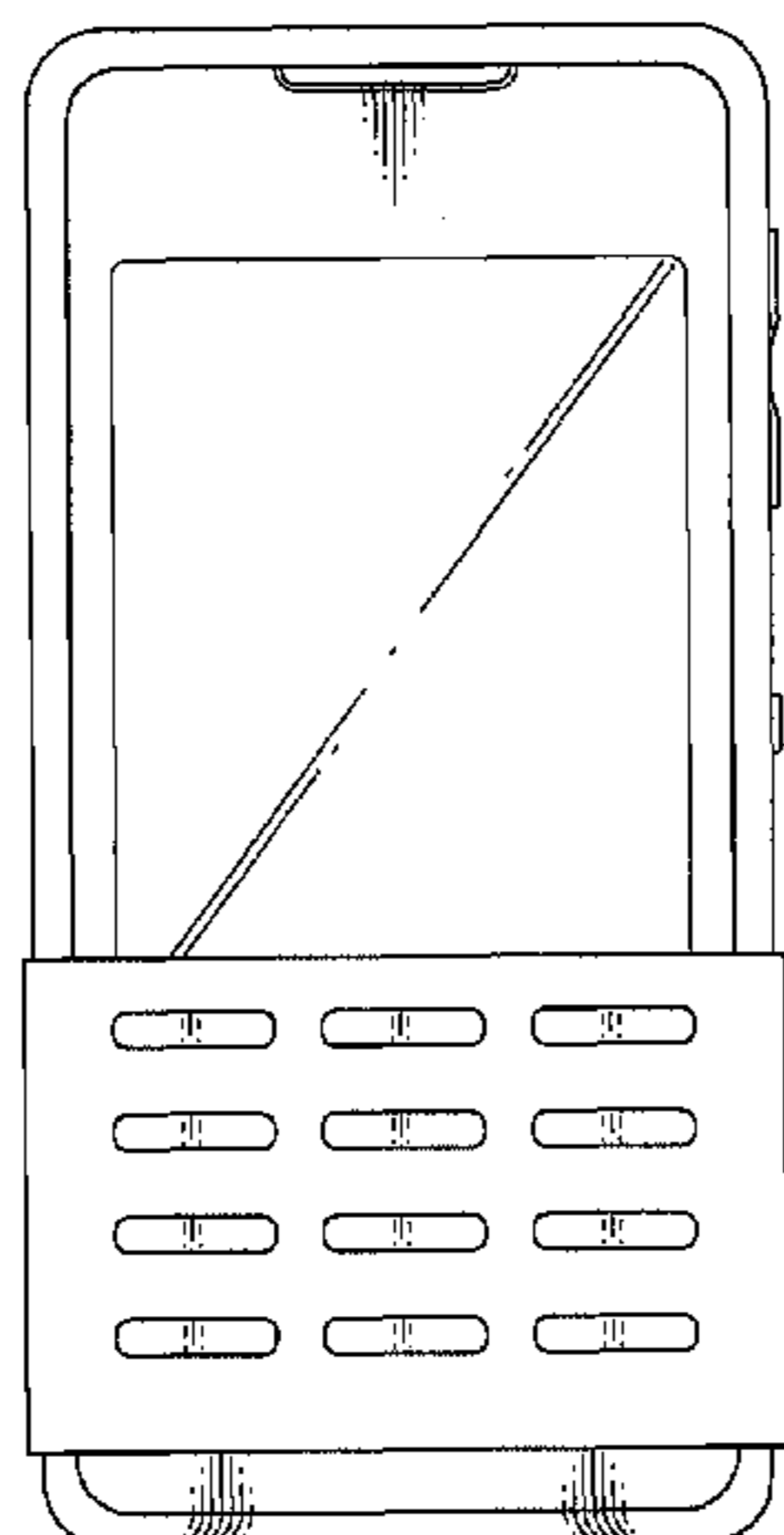

US D603,361 S

Page 2

U.S. PATENT DOCUMENTS

D584,272 S *	1/2009	Chung et al.	D14/138 G	D592,628 S *	5/2009	Kim et al.	D14/138 AD
D584,738 S *	1/2009	Kim et al.	D14/496	D593,059 S *	5/2009	Kim et al.	D14/138 G
D585,040 S *	1/2009	Kim et al.	D14/138 G	2002/0072395 A1 *	6/2002	Miramontes	455/566
D587,669 S *	3/2009	Aarras	D14/138 AA	2003/0157957 A1 *	8/2003	Wendorff et al.	455/550
D589,924 S *	4/2009	Jung et al.	D14/138 AD	2009/0051658 A1 *	2/2009	Frohlund	345/169
D591,252 S *	4/2009	Kim et al.	D14/138 G	2009/0111508 A1 *	4/2009	Yeh et al.	455/552.1

* cited by examiner

FIG. 1

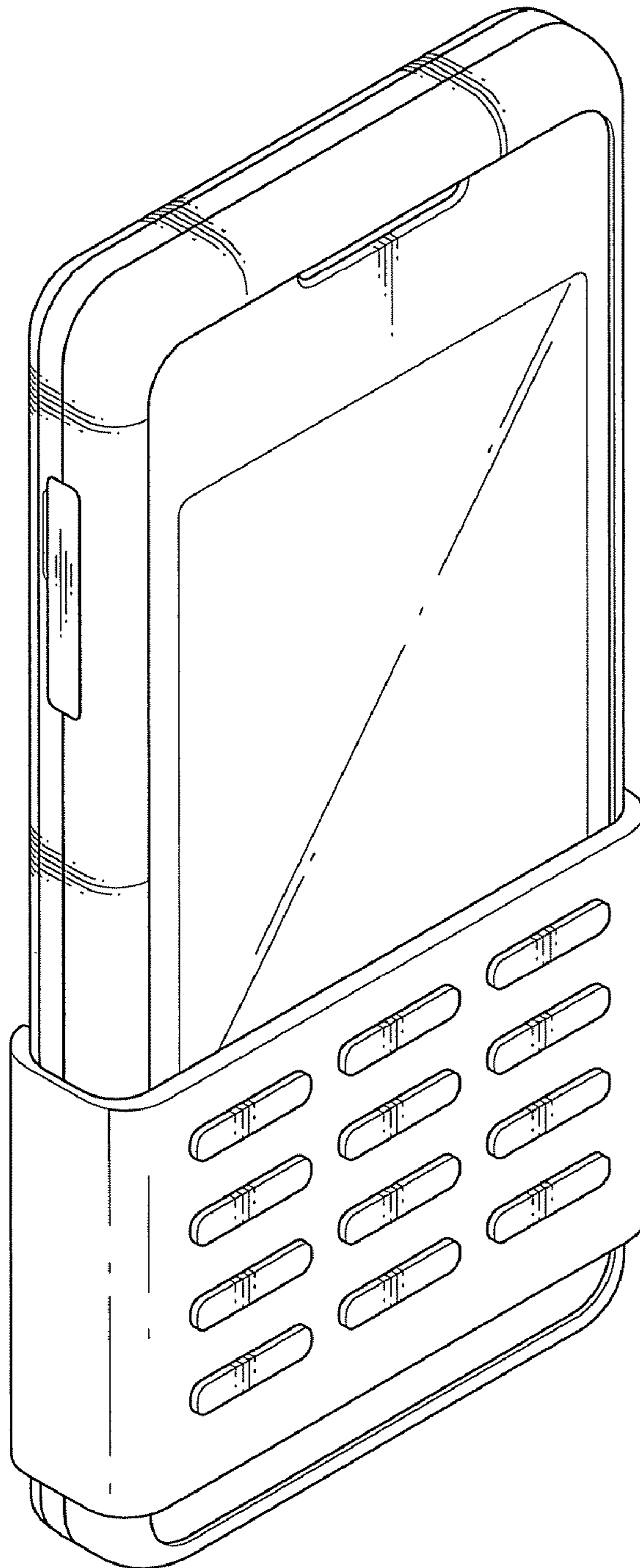

FIG.2

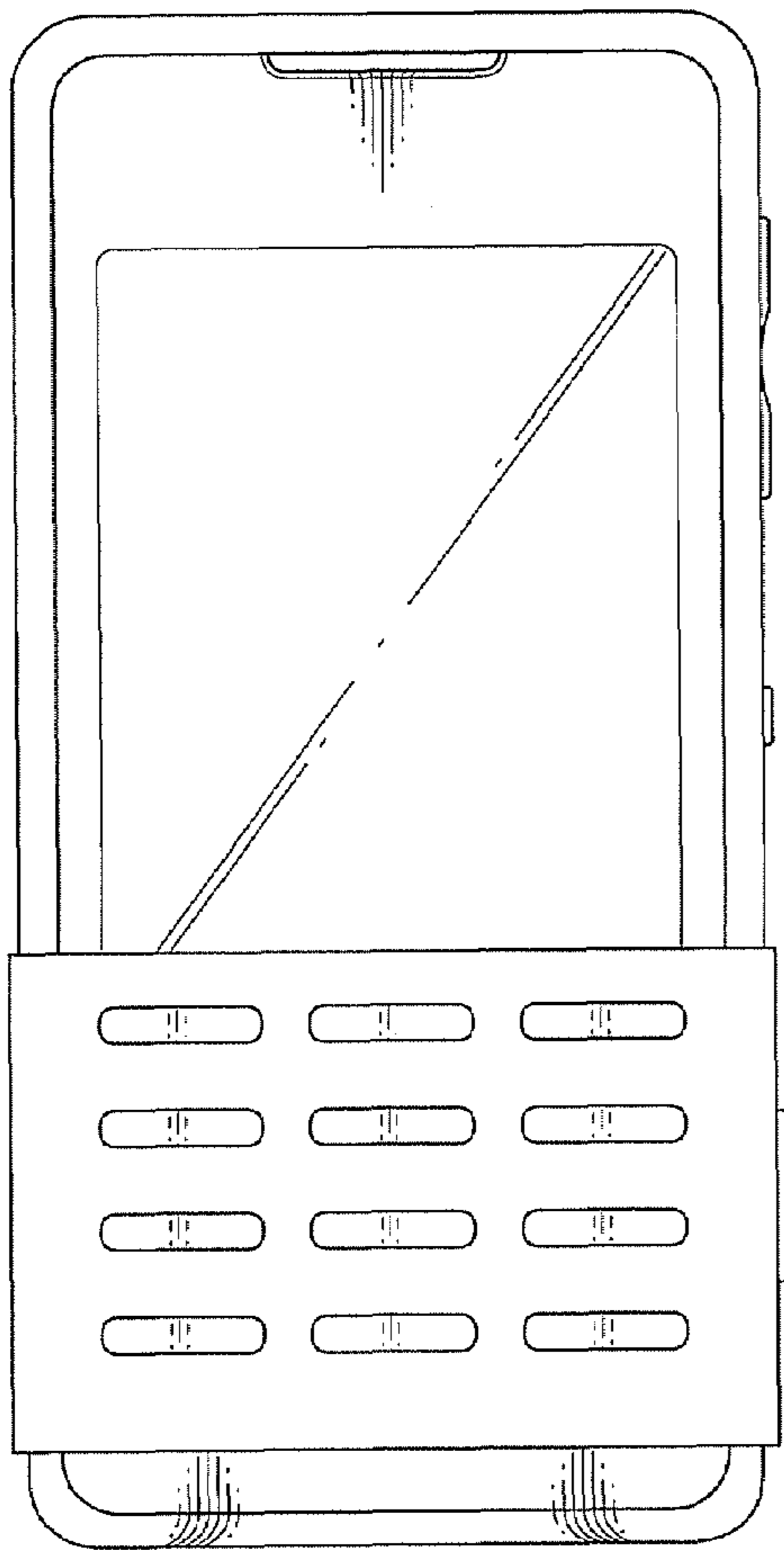

FIG.3

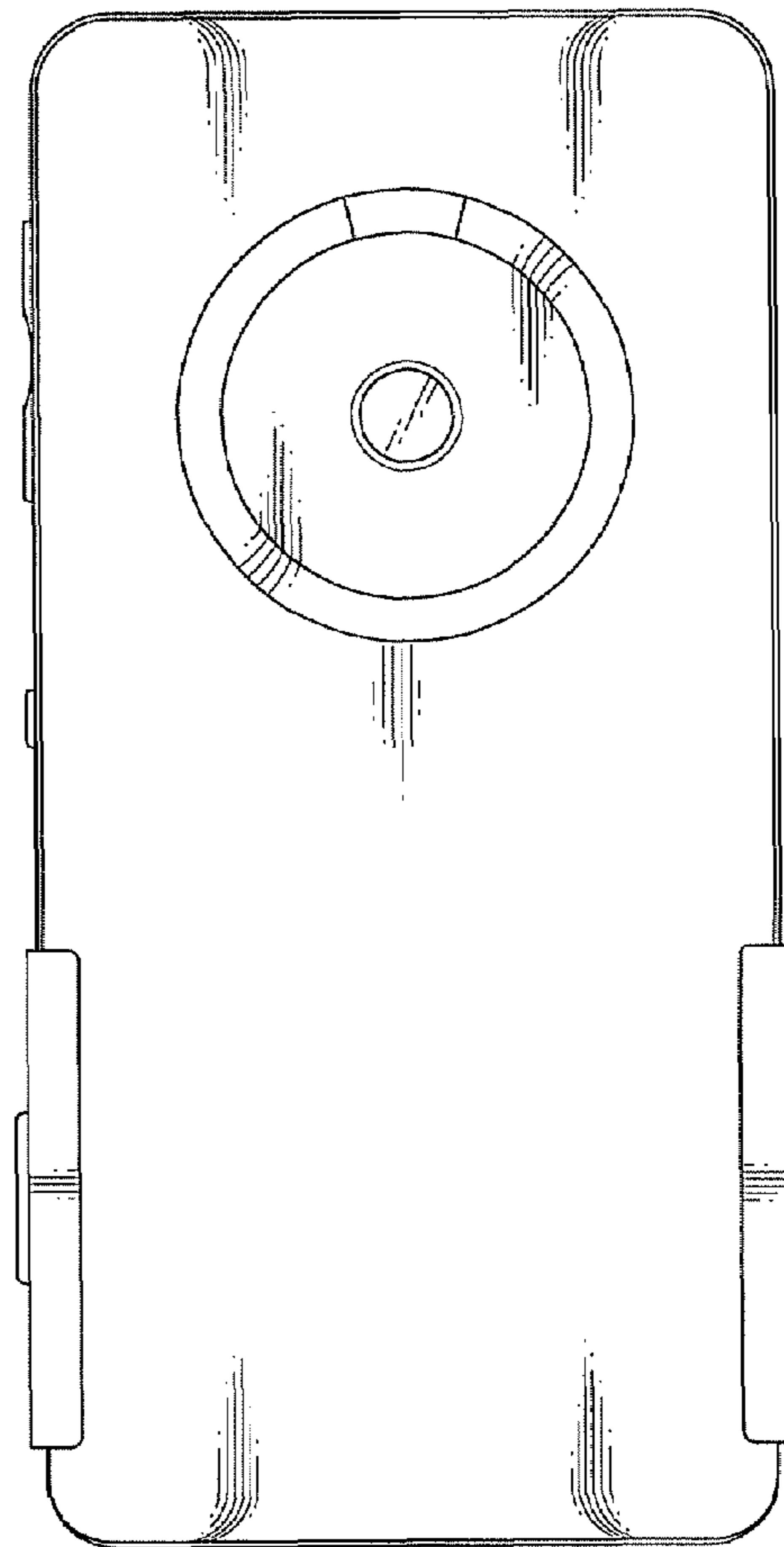

FIG.4

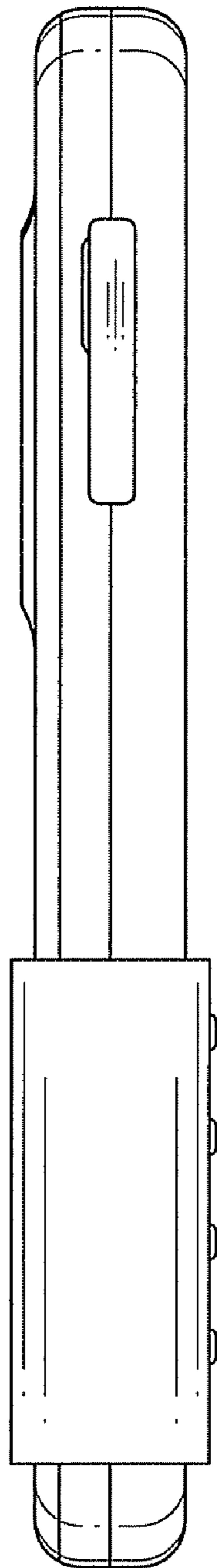

FIG.5

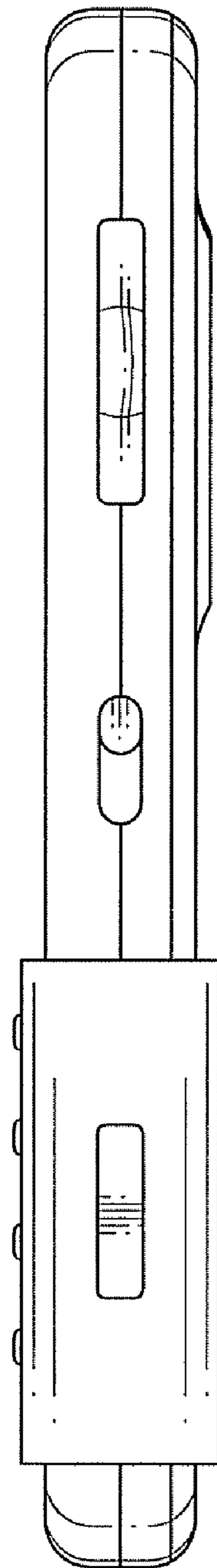

FIG. 6

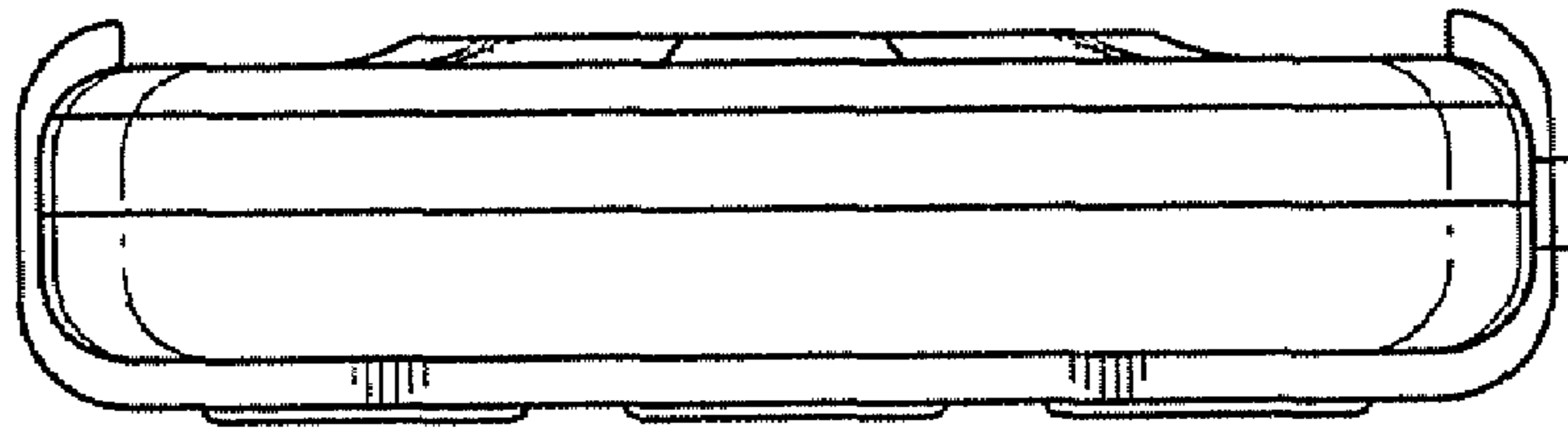

FIG. 7

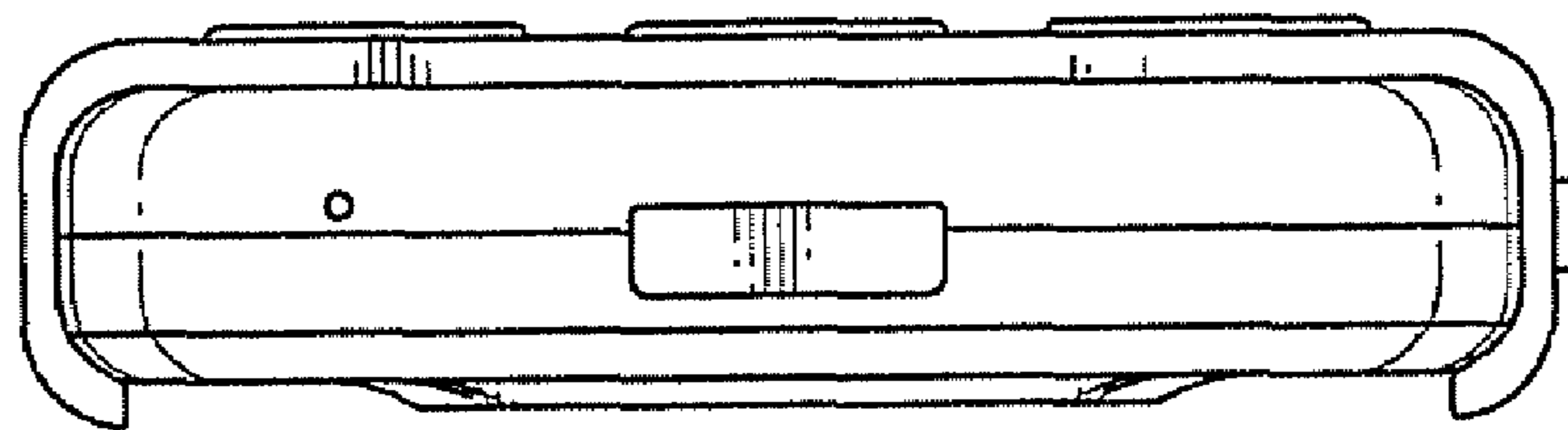

FIG. 8

