



US00D603306S

(12) **United States Design Patent**
Jung et al.

(10) **Patent No.:** **US D603,306 S**

(45) **Date of Patent:** **** Nov. 3, 2009**

(54) **PORTION OF A VEHICLE EXTERIOR**

(75) Inventors: **Chi Jung**, Torrance, CA (US); **Satoru Kato**, Redondo Beach, CA (US)

(73) Assignee: **Honda Motor Co., Ltd.**, Tokyo (JP)

(**) Term: **14 Years**

(21) Appl. No.: **29/326,554**

(22) Filed: **Oct. 20, 2008**

(51) **LOC (9) Cl.** **12-16**

(52) **U.S. Cl.** **D12/164; D12/196**

(58) **Field of Classification Search** D12/164,
D12/196, 90-92, 86; 296/181.1, 181.5
See application file for complete search history.

(56) **References Cited**

U.S. PATENT DOCUMENTS

D420,317 S *	2/2000	Ney	D12/196
D424,980 S *	5/2000	Hunter et al.	D12/91
D456,844 S *	5/2002	Oka	D12/196
D457,115 S *	5/2002	Mahoney et al.	D12/196
D491,855 S *	6/2004	Velazco	D12/196
D494,913 S *	8/2004	Chapman	D12/196
D505,890 S *	6/2005	Kubota et al.	D12/91
D510,543 S *	10/2005	Matsuoka et al.	D12/91
D520,928 S *	5/2006	Matei et al.	D12/196
D539,190 S	3/2007	Brown et al.		

* cited by examiner

Primary Examiner—Melody N Brown

(74) *Attorney, Agent, or Firm*—Plumsea Law Group, LLC; Mark E. Duell

(57) **CLAIM**

The ornamental design for a portion of a vehicle exterior, as shown and described.

DESCRIPTION

FIG. 1 is a rear perspective view of a portion of a vehicle exterior showing our new design;

FIG. 2 is a front perspective view thereof;

FIG. 3 is front perspective view of the opposite side thereof;

FIG. 4 is a rear perspective view of the opposite side thereof;

FIG. 5 is a side elevational view thereof;

FIG. 6 is a side elevational view of the opposite side thereof; and,

FIG. 7 is a rear elevational view thereof.

The broken line showings of the wheels, tires, fuel door, rear windshield wiper, tail pipes, and the remainder of the vehicle depict environmental subject matter and form no part of the claimed design.

1 Claim, 7 Drawing Sheets

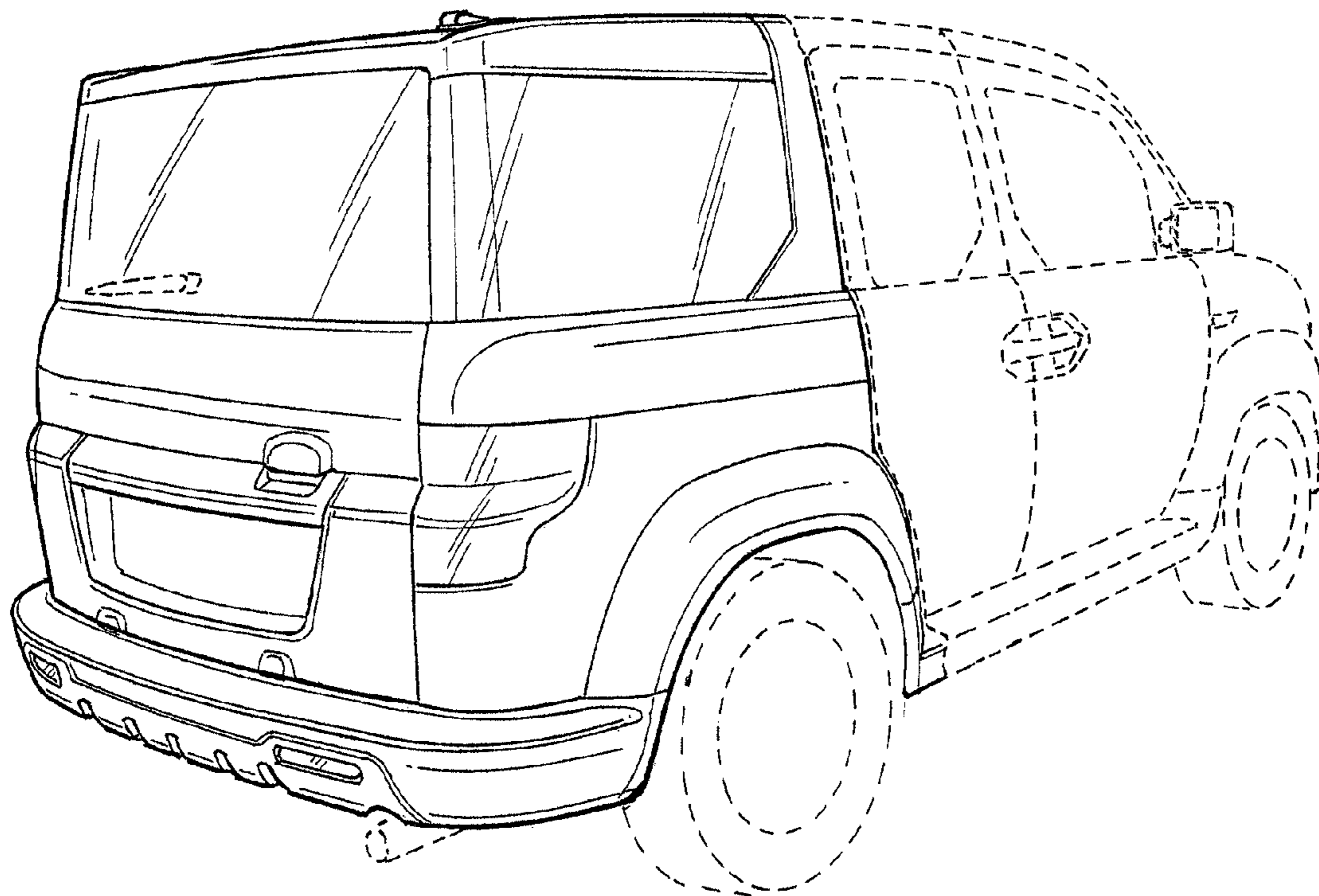

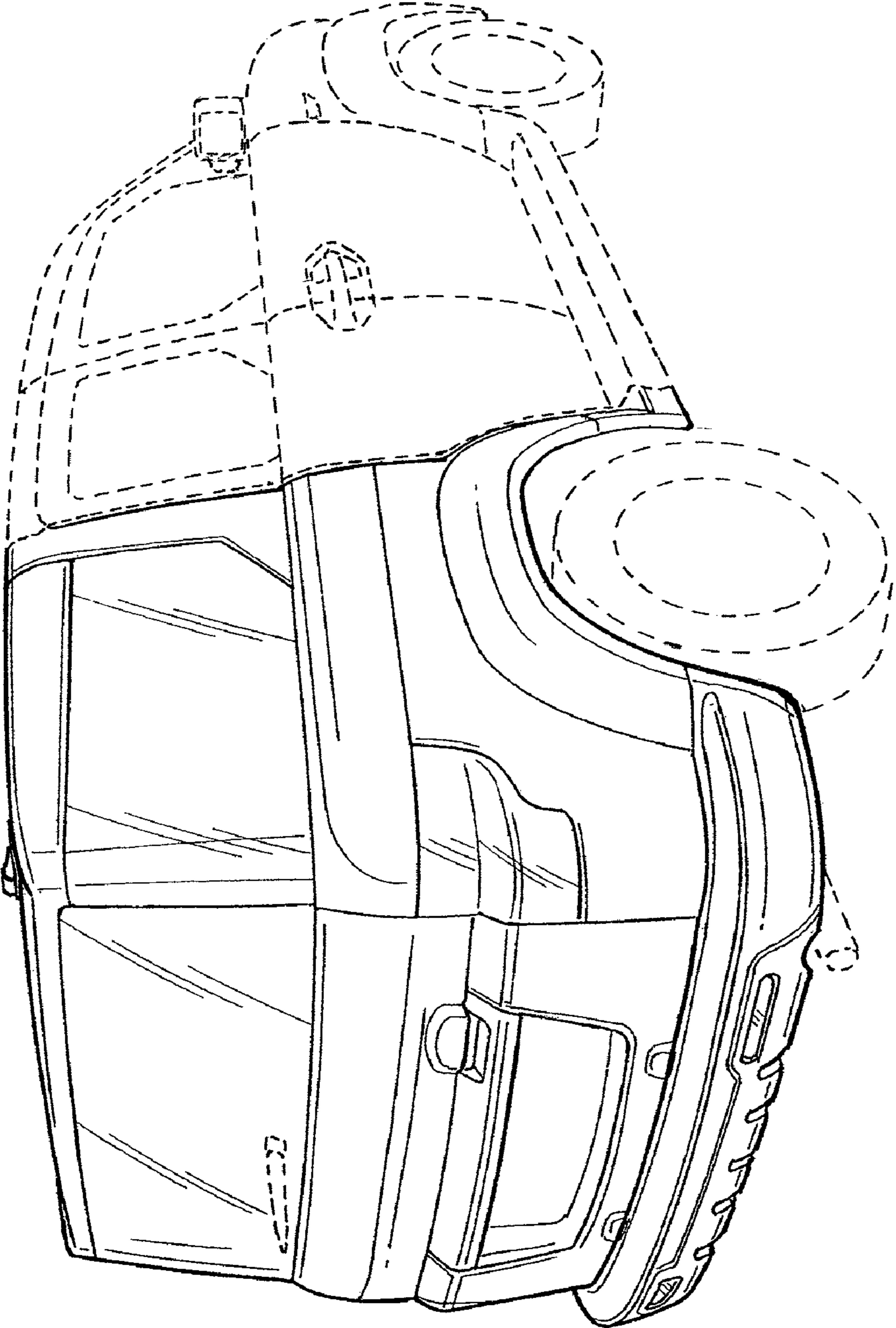

FIG.1

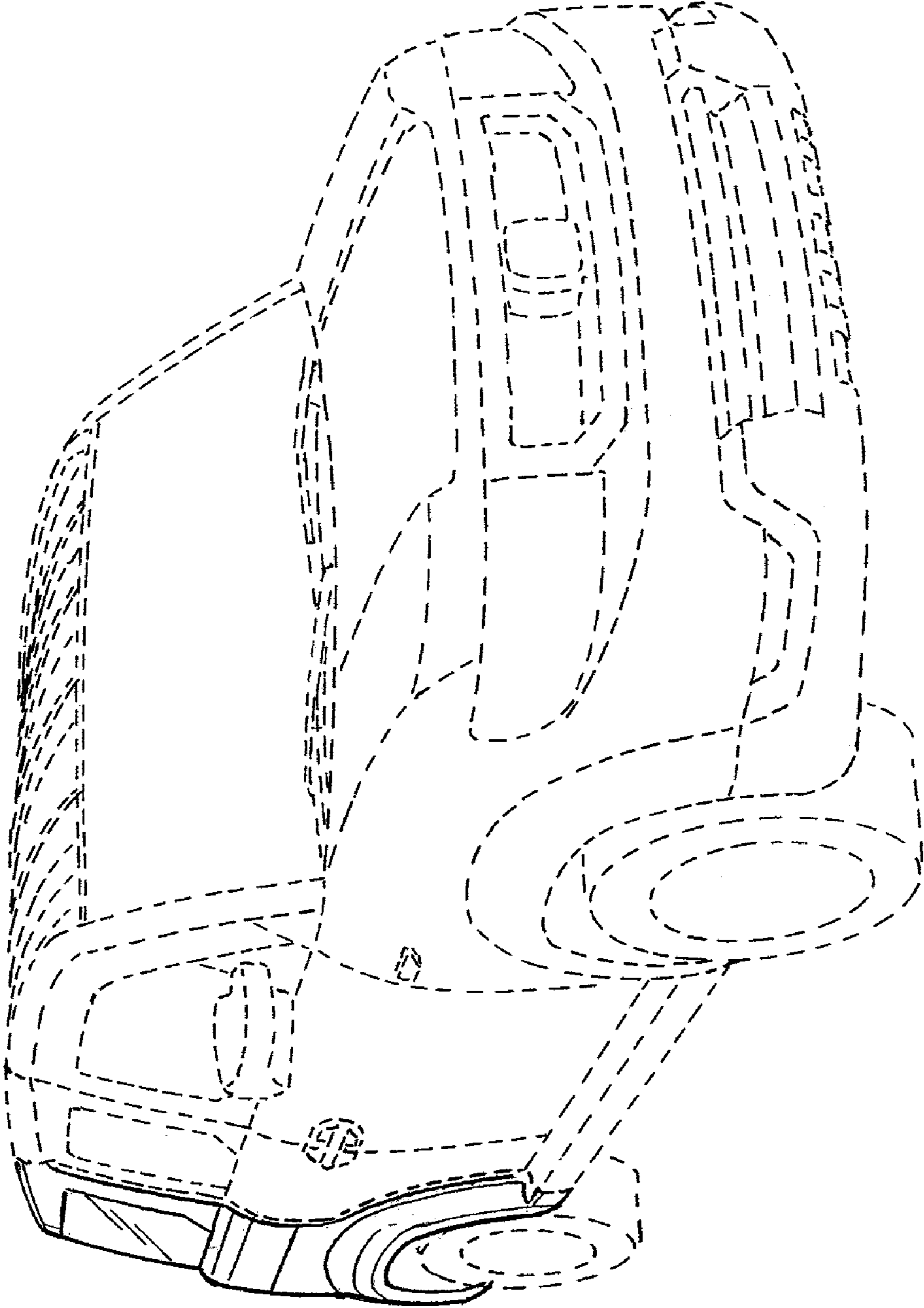

FIG. 2

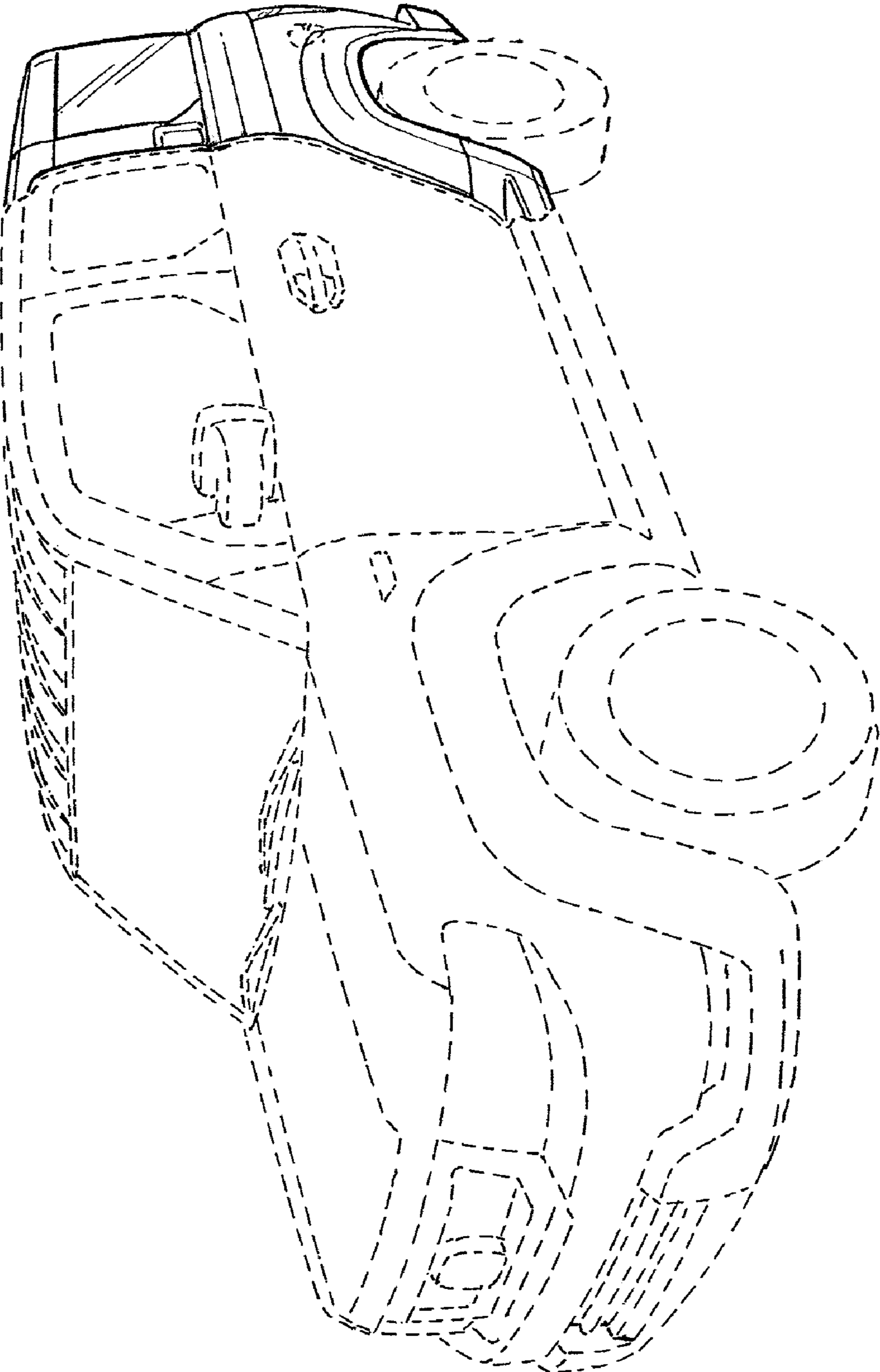

FIG. 3

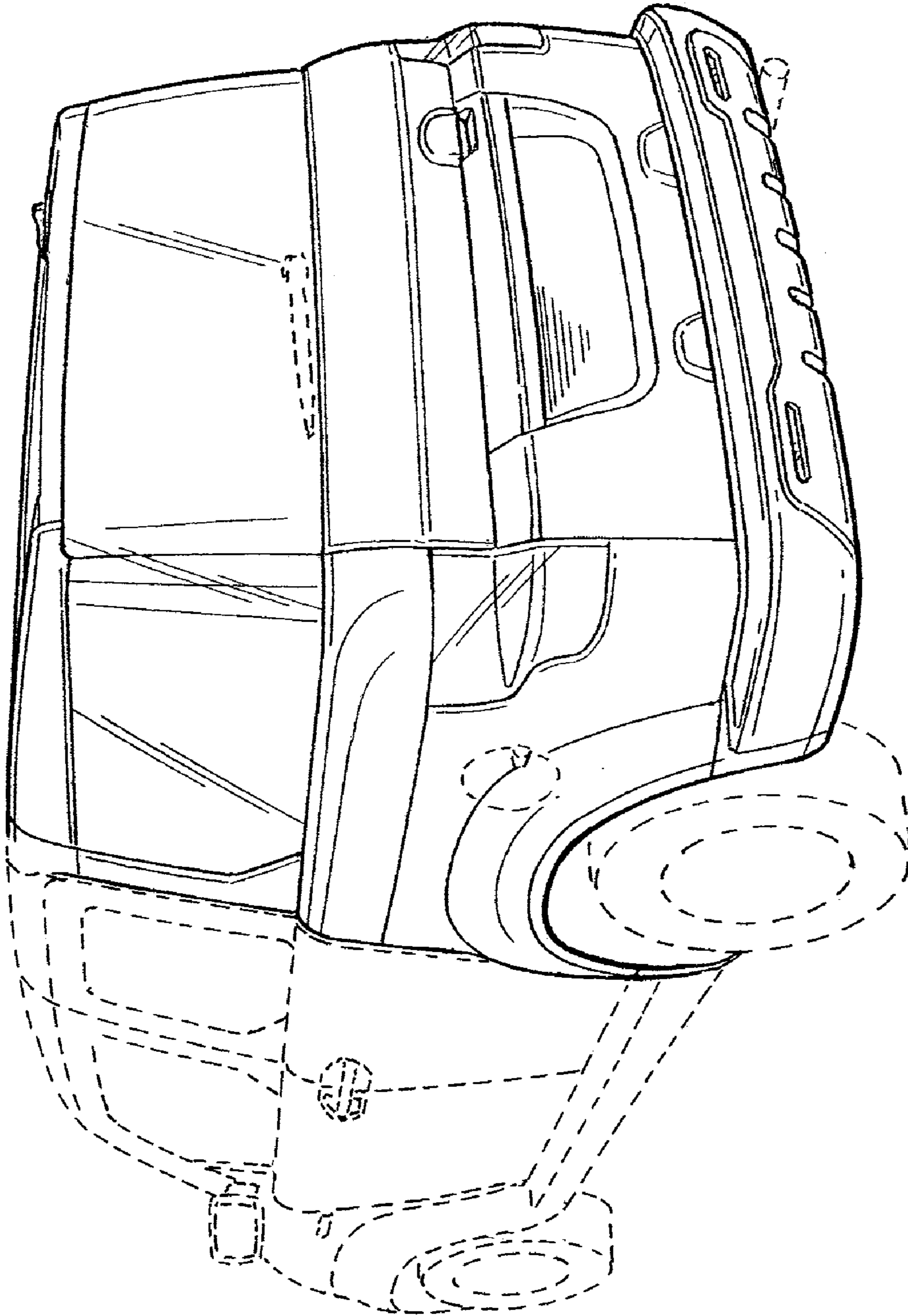

FIG. 4

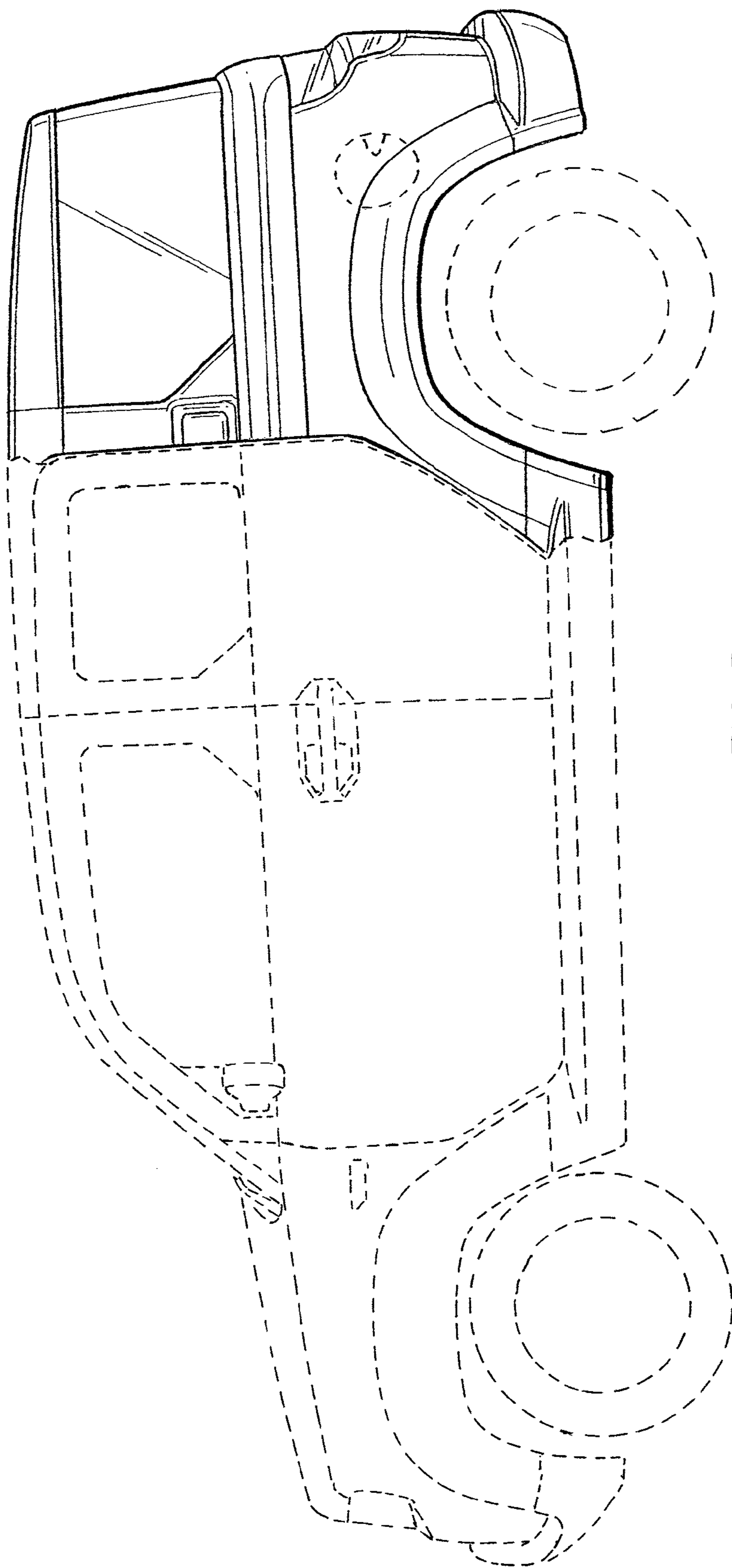

FIG. 5

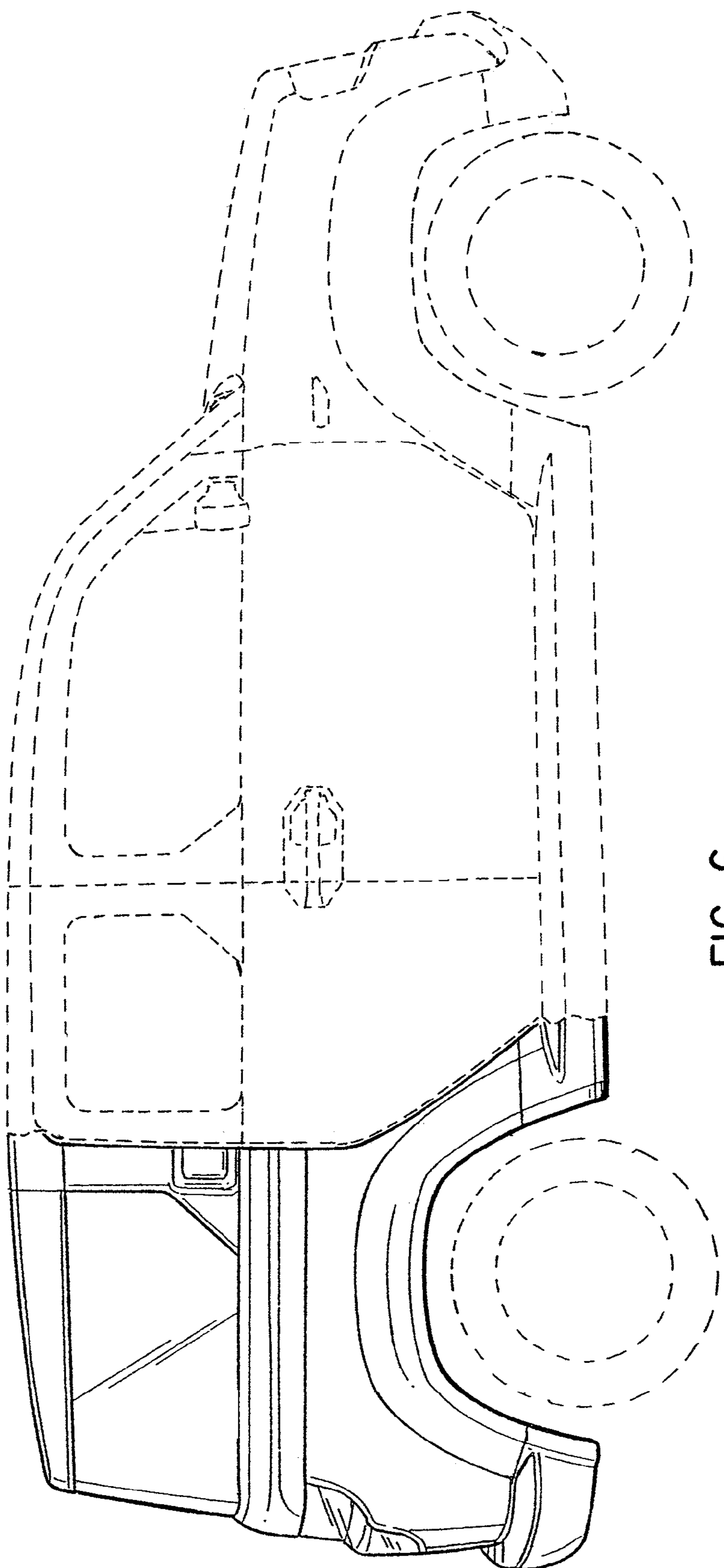

FIG. 6

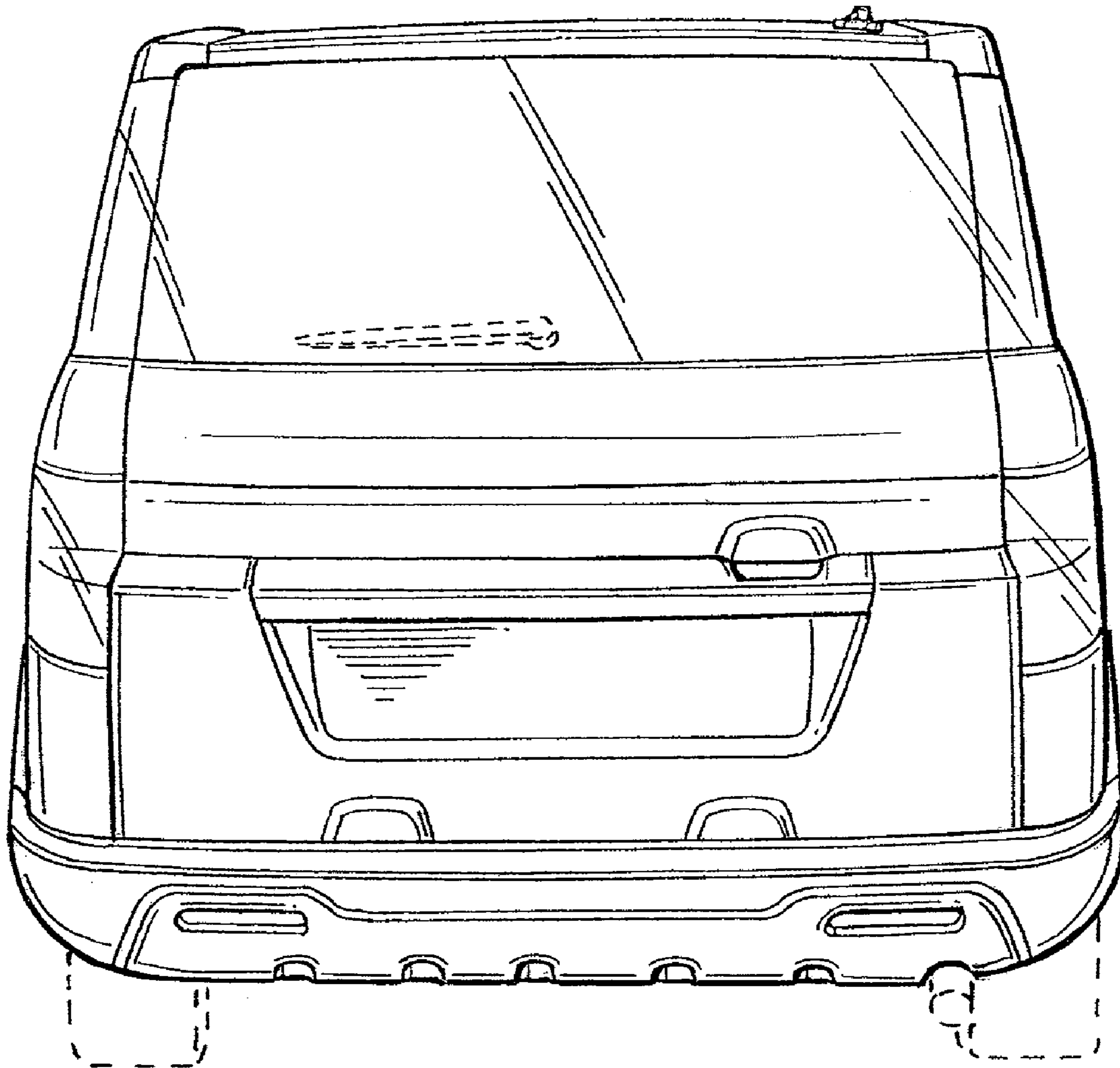

FIG. 7