



US00D603300S

(12) **United States Design Patent**  
**Fukuyama et al.**

(10) **Patent No.:** **US D603,300 S**  
(45) **Date of Patent:** **\*\* Nov. 3, 2009**

(54) **MOTORCYCLE OR MOTORCYCLE REPLICA**

(75) Inventors: **Kei Fukuyama**, Wako (JP); **Satoshi Ito**, Wako (JP)

(73) Assignee: **Honda Motor Co., Ltd.**, Tokyo (JP)

(\*\*) Term: **14 Years**

(21) Appl. No.: **29/309,736**

(22) Filed: **Sep. 30, 2008**

(30) **Foreign Application Priority Data**

Mar. 31, 2008 (JP) ..... 2008-008164

(51) **LOC (9) Cl.** ..... **12-11**

(52) **U.S. Cl.** ..... **D12/110**

(58) **Field of Classification Search** ..... D12/110;  
180/219, 225, 229

See application file for complete search history.

(56) **References Cited**

**U.S. PATENT DOCUMENTS**

- D387,017 S \* 12/1997 Wakita et al. .... D12/110
- D497,330 S \* 10/2004 Fukuyama et al. .... D12/110
- D517,956 S \* 3/2006 Kishi et al. .... D12/110
- D535,587 S \* 1/2007 Yin et al. .... D12/110

\* cited by examiner

*Primary Examiner*—Robin V Webster

*Assistant Examiner*—Linda Brooks

(74) *Attorney, Agent, or Firm*—Birch, Stewart, Kolasch & Birch, LLP

(57) **CLAIM**

The ornamental design for a motorcycle or motorcycle replica, as shown and described.

**DESCRIPTION**

FIG. 1 is a front view of the motorcycle or motorcycle replica showing our new design;

FIG. 2 is a rear view thereof;

FIG. 3 is a top plan view thereof;

FIG. 4 is a bottom view thereof;

FIG. 5 is a right side view thereof;

FIG. 6 is a left side view thereof;

FIG. 7 is a perspective view thereof as seen from the right front side;

FIG. 8 is a perspective view thereof as seen from the left front side;

FIG. 9 is a perspective view thereof as seen from the right rear side; and,

FIG. 10 is a perspective view thereof as seen from the left rear side.

**1 Claim, 6 Drawing Sheets**

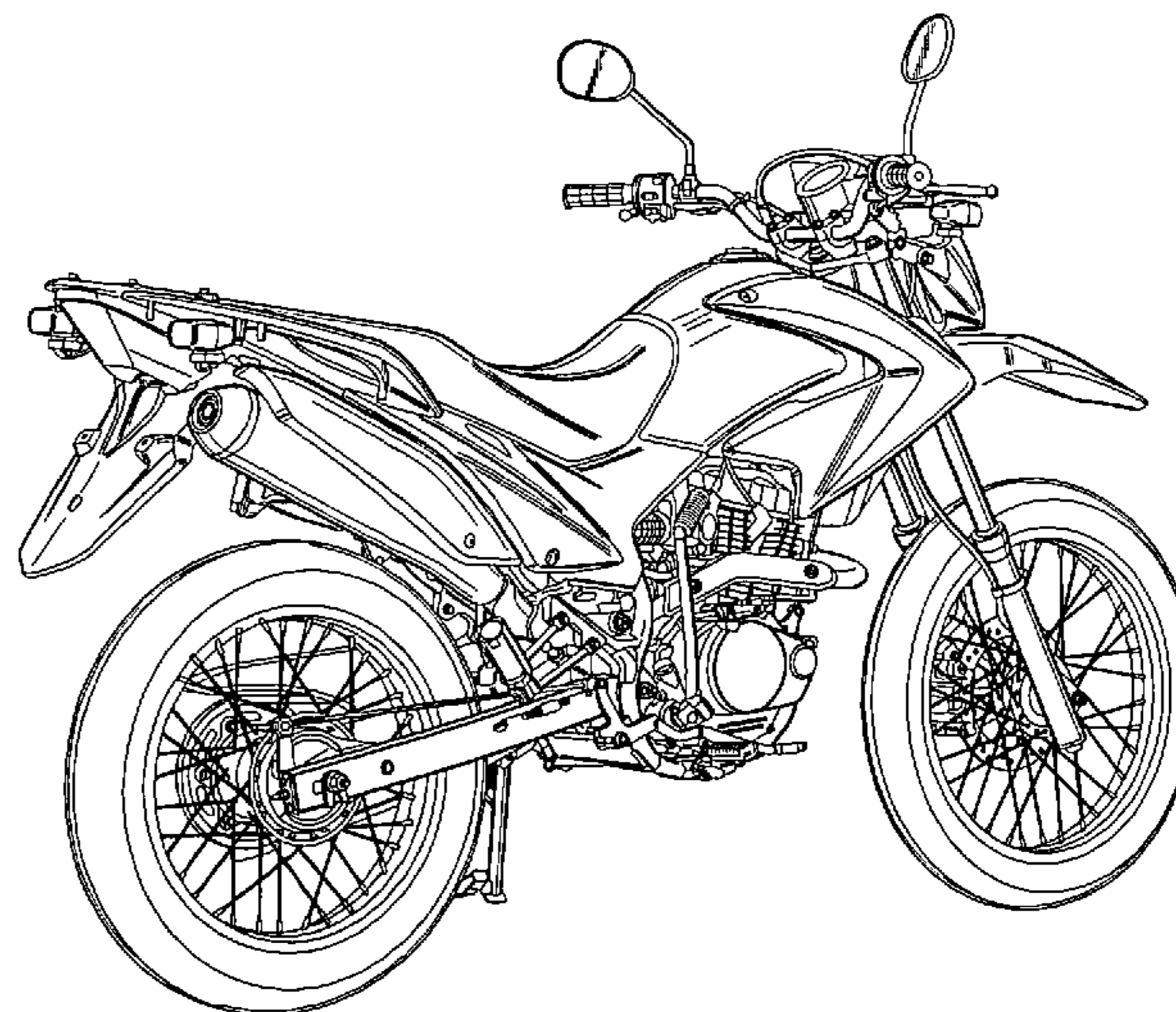
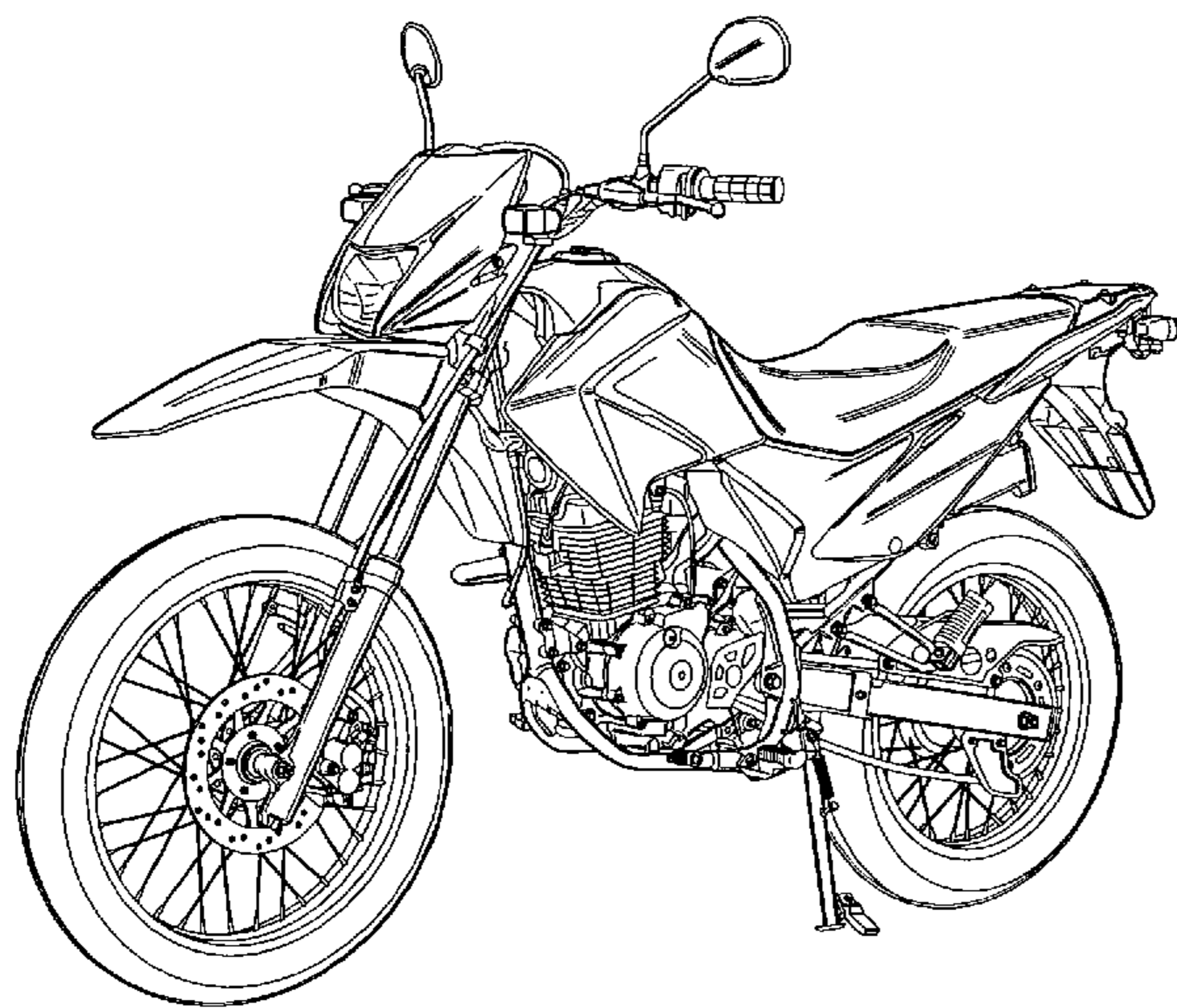

FIG.1

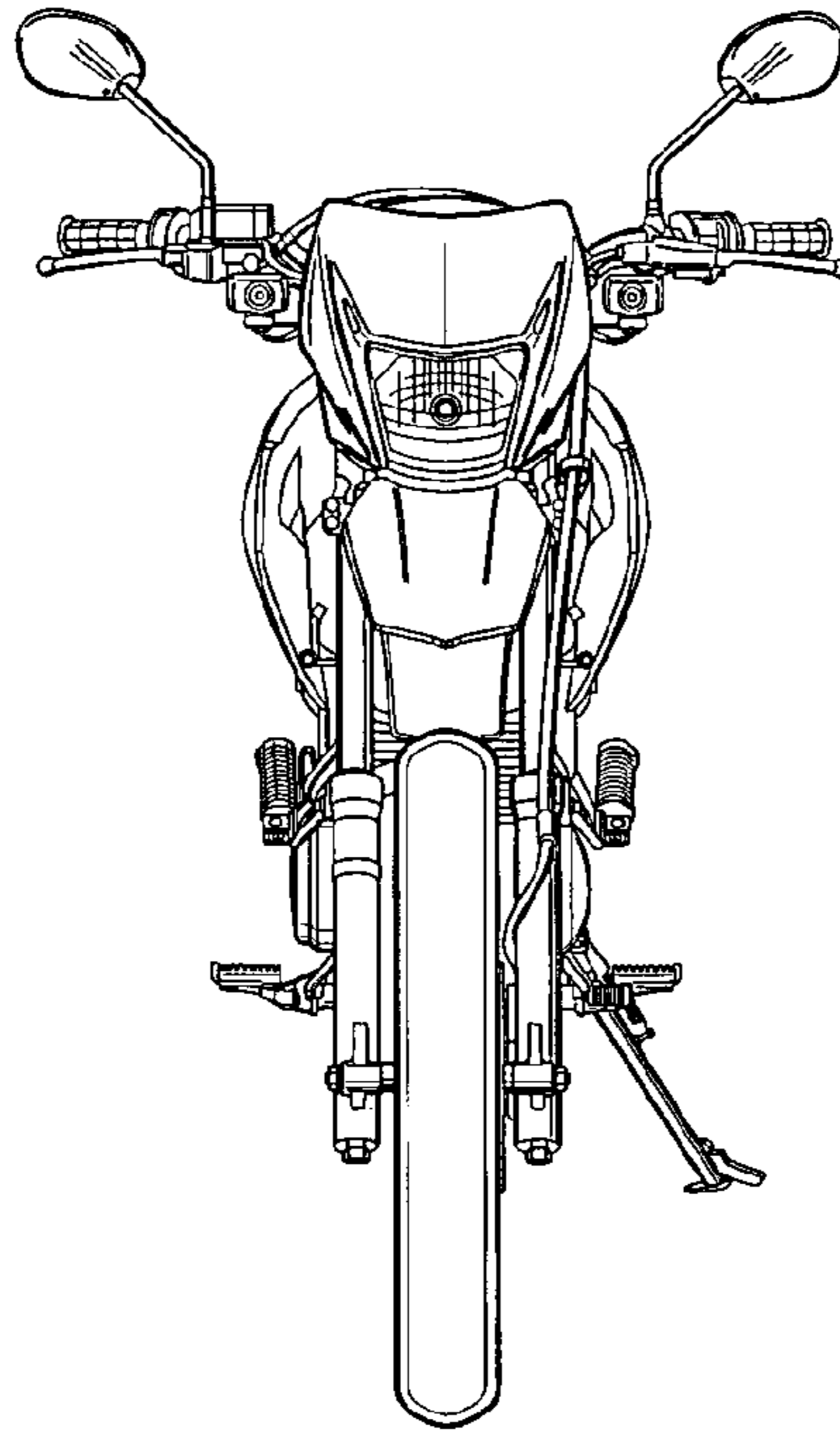

FIG.2

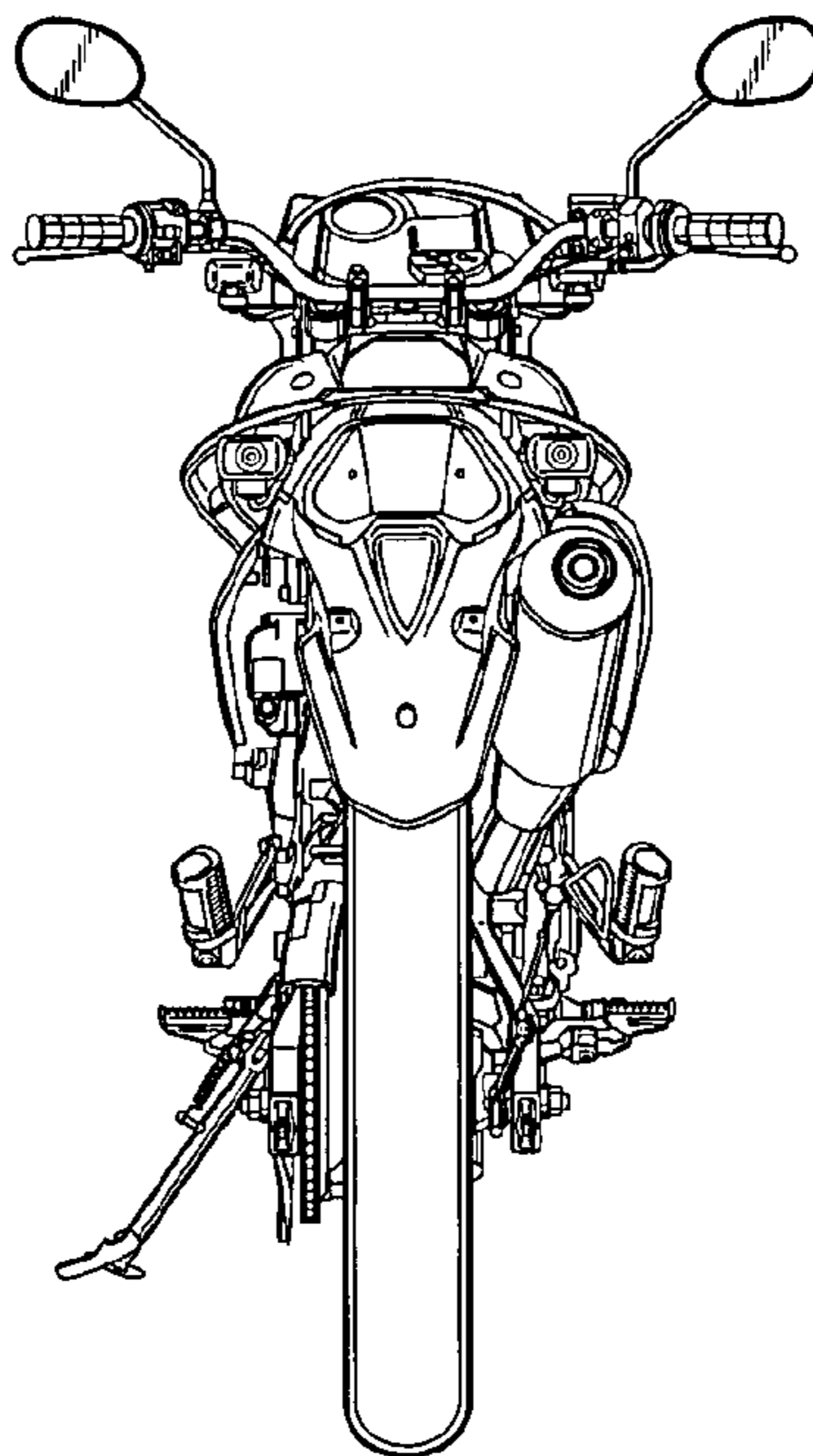

FIG.3

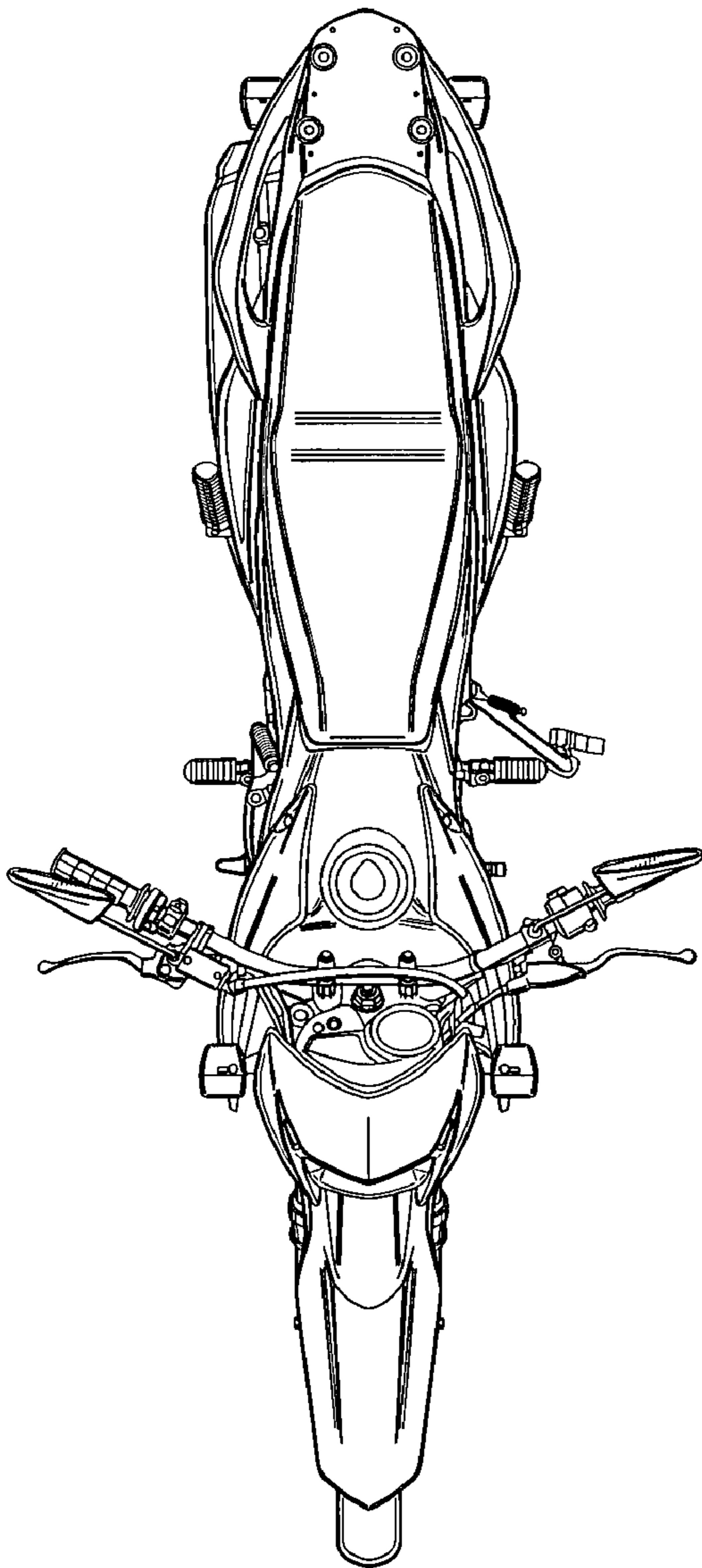

FIG.4

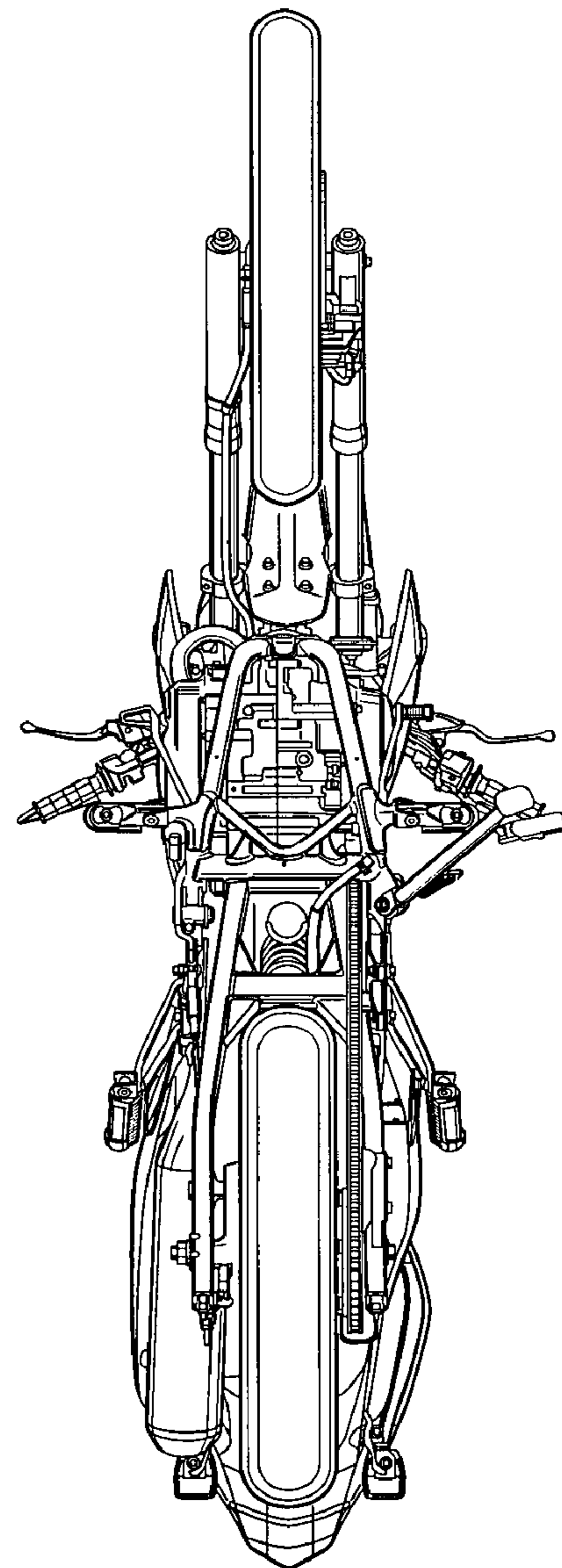

FIG.5

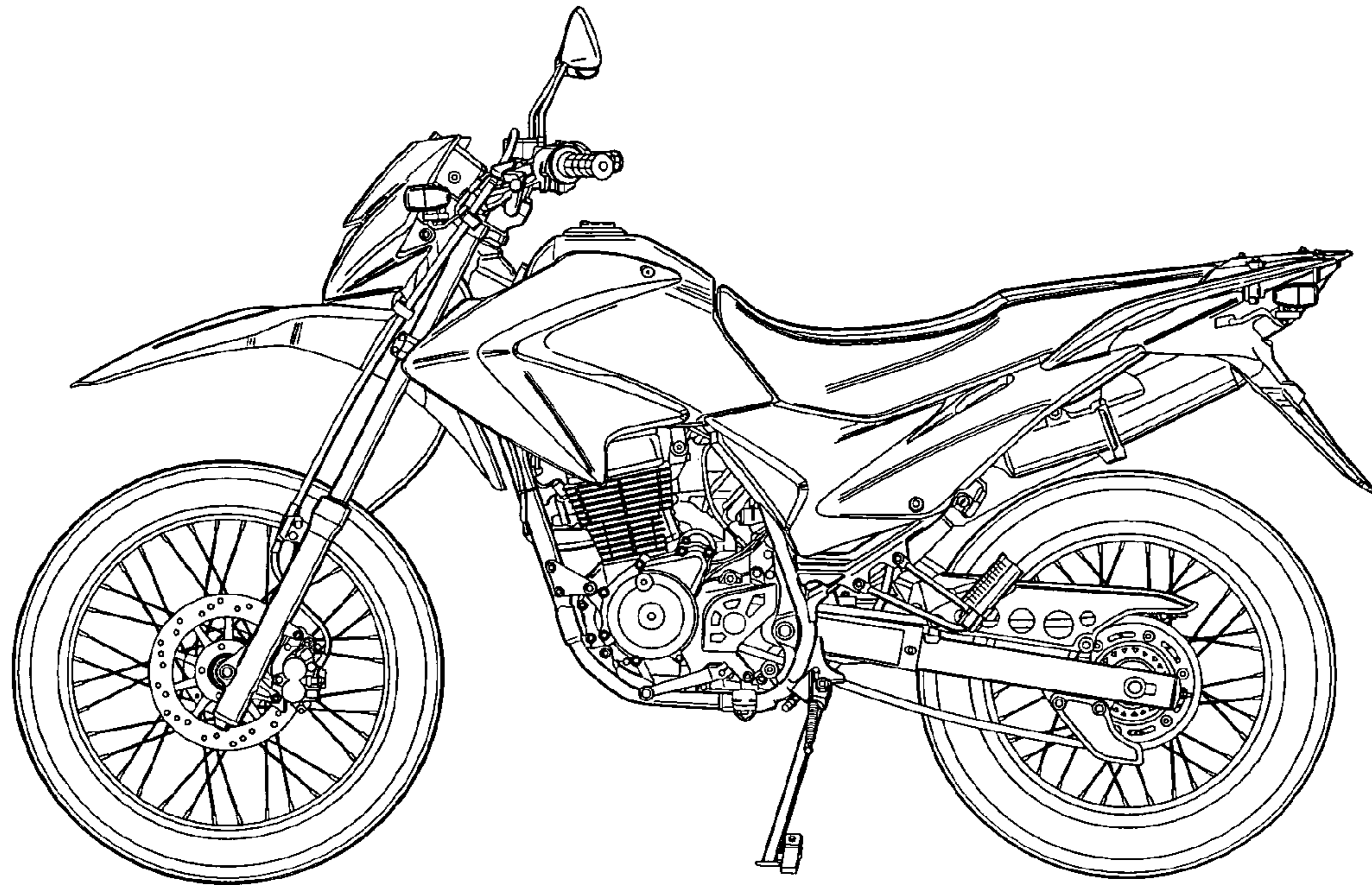

FIG.6

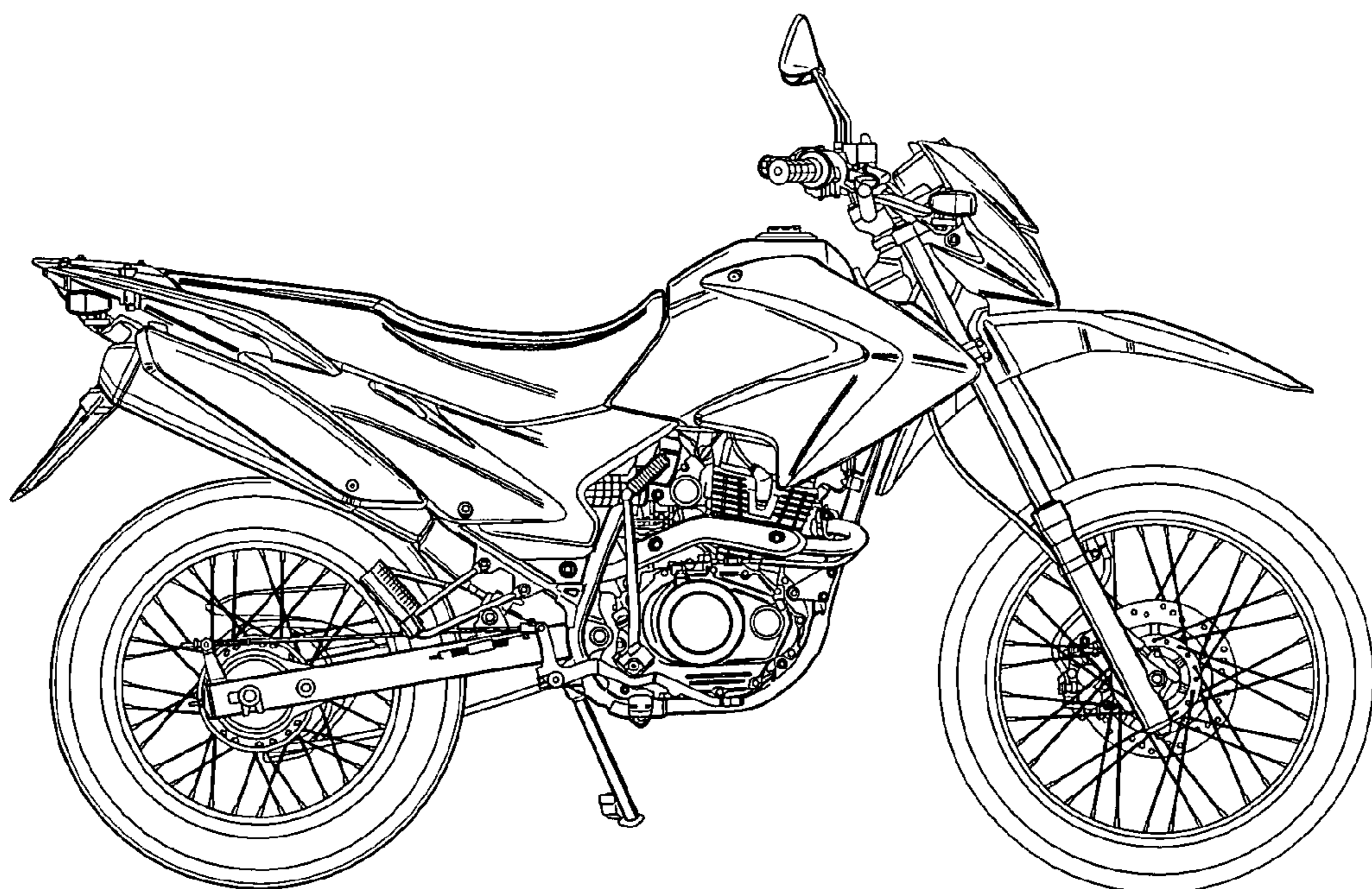

FIG.7

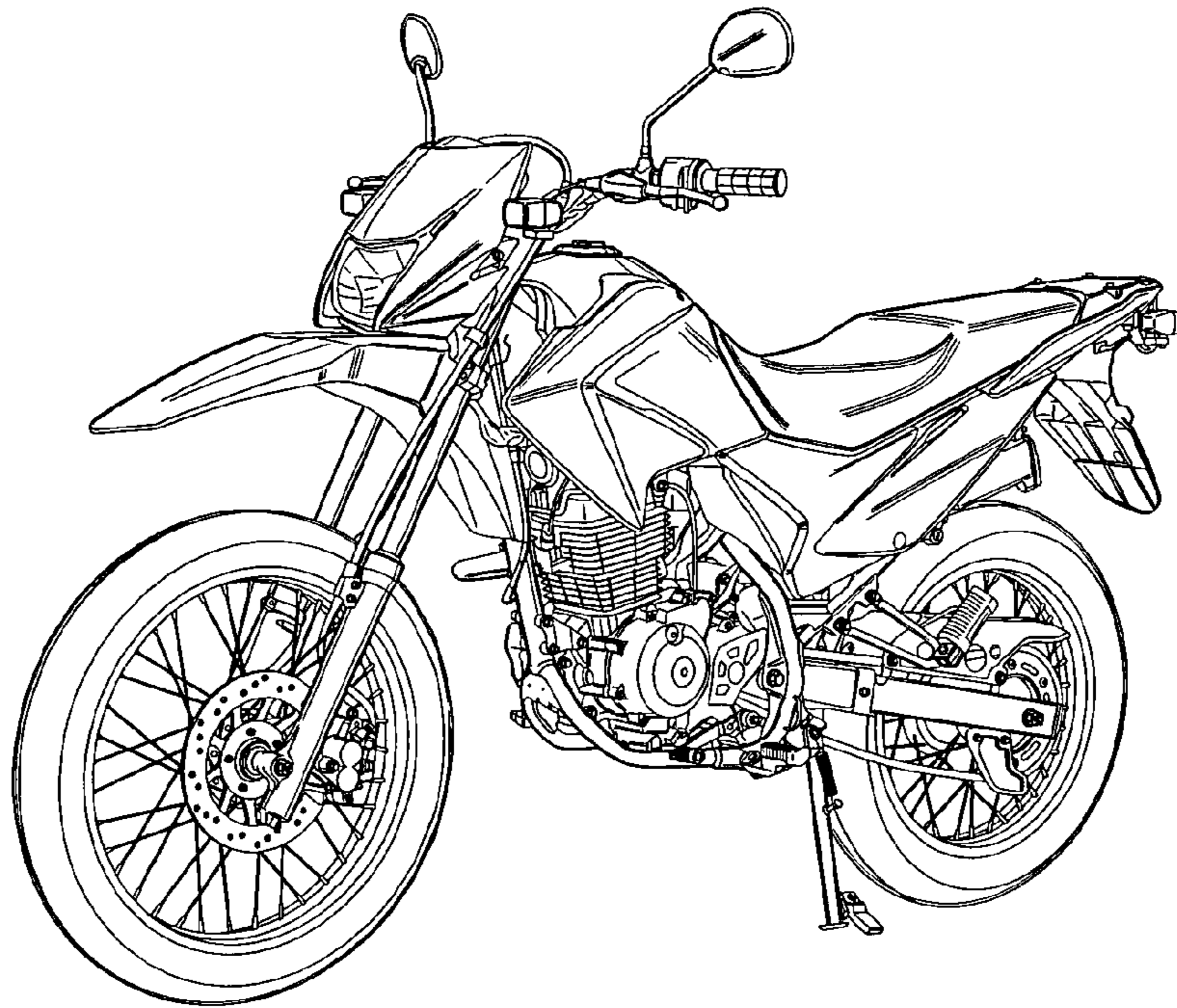

FIG.8

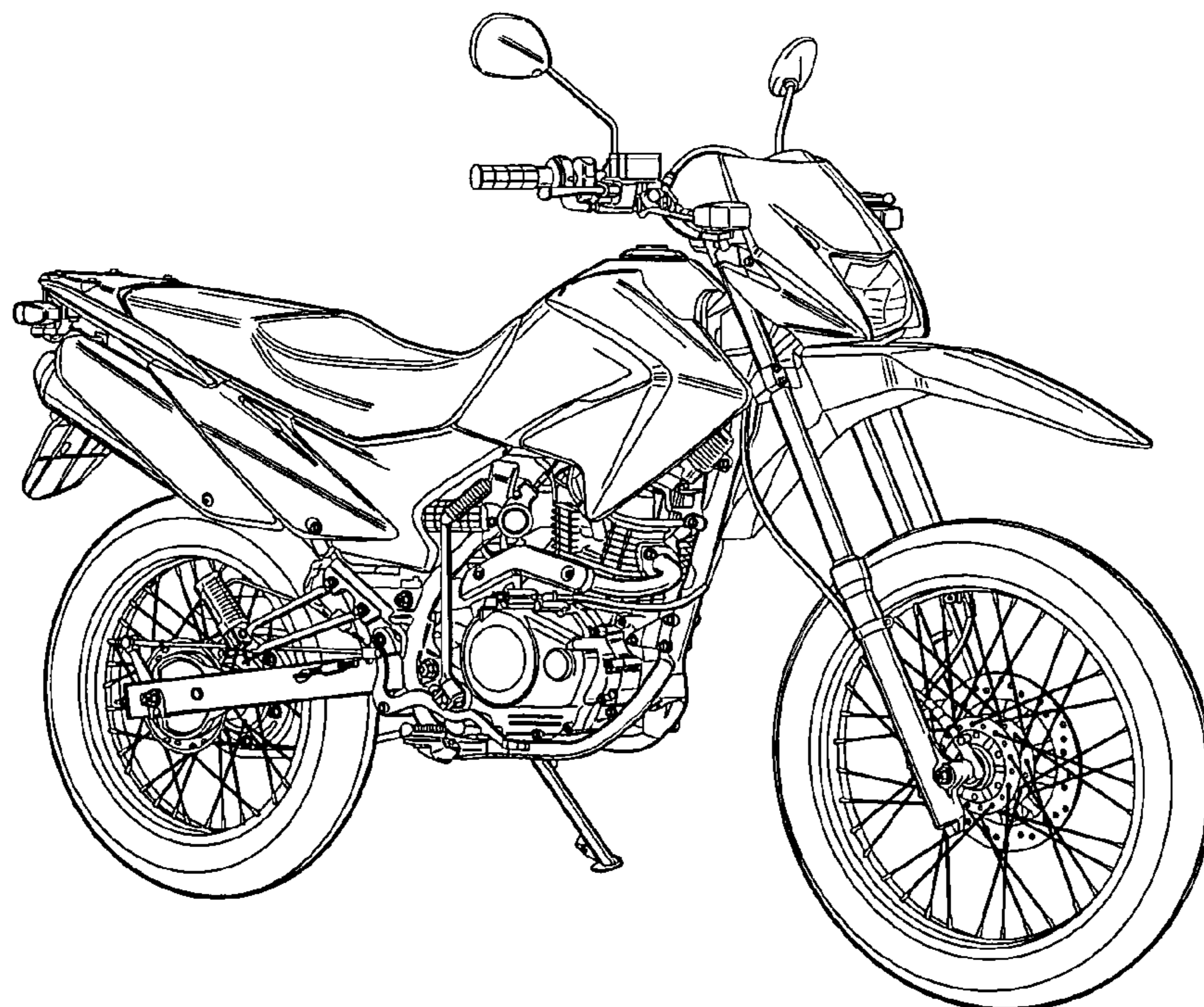

FIG. 9

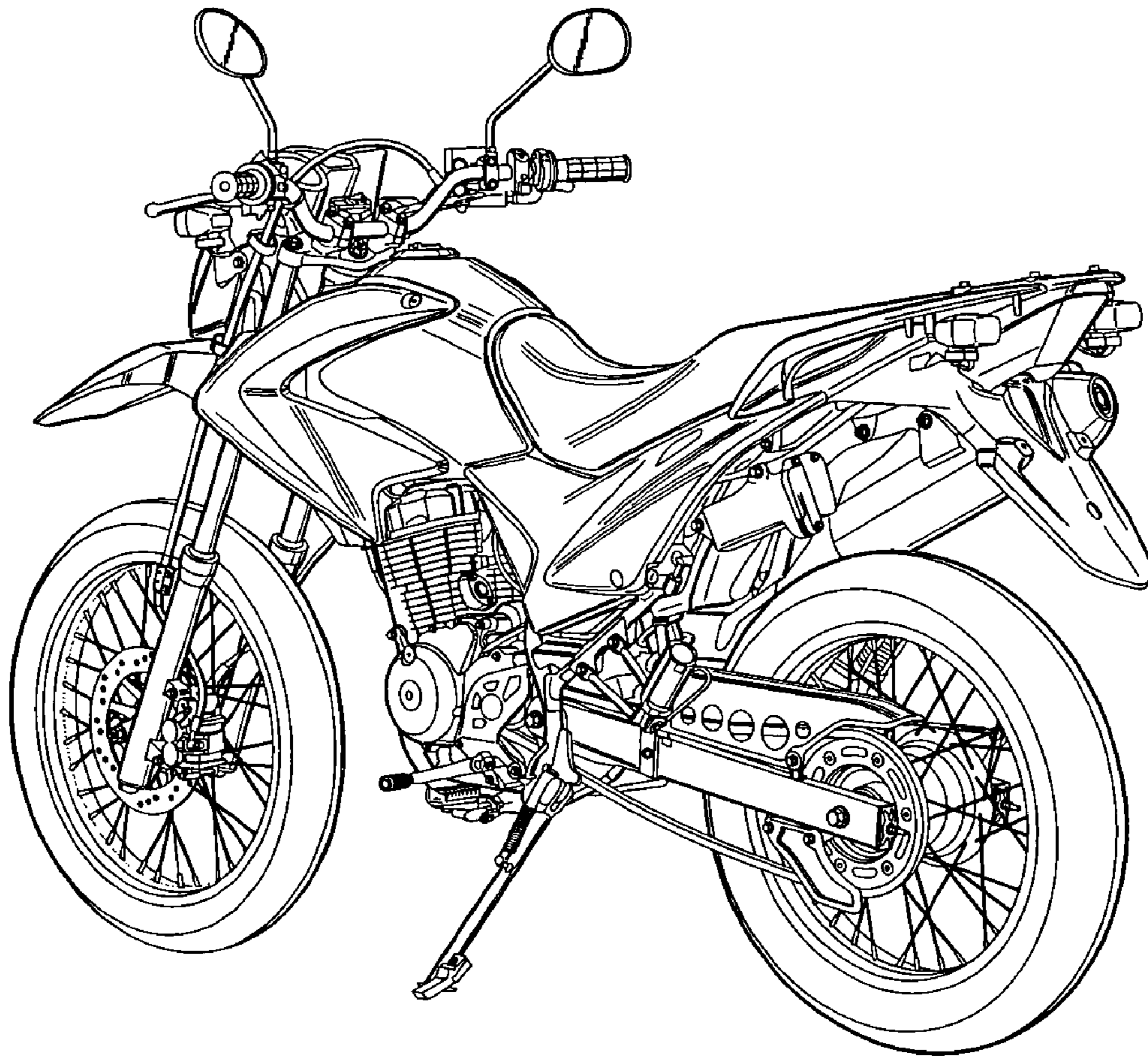

FIG.10

