



US00D603262S

(12) **United States Design Patent**
Dickinson

(10) **Patent No.:** **US D603,262 S**

(45) **Date of Patent:** **** Nov. 3, 2009**

(54) **BAG HOLDER**

(75) Inventor: **Adam Dickinson**, Lichfield (GB)

(73) Assignee: **Euro Packaging Ltd.**, Birmingham (GB)

(**) Term: **14 Years**

(21) Appl. No.: **29/304,843**

(22) Filed: **Mar. 7, 2008**

(30) **Foreign Application Priority Data**

Sep. 10, 2007 (EM) 000789318

(51) **LOC (9) Cl.** **09-07**

(52) **U.S. Cl.** **D9/455; D20/42**

(58) **Field of Classification Search** D9/717,
D9/709, 704, 670, 660, 658, 652, 646, 632,
D9/605, 604, 601, 457, 454, 453, 451, 441,
D9/439, 436, 434, 424, 415; D5/61, 60,
D5/58; D3/303, 276; D20/28, 42; D14/492,
D14/489; D11/221; 53/133.4; 383/64, 61.2,
383/5; 206/470, 469, 468, 462; 220/212;
222/78

See application file for complete search history.

(56) **References Cited**

U.S. PATENT DOCUMENTS

D277,554 S * 2/1985 Chabot D9/434
D294,127 S * 2/1988 Chmela D9/434
D361,935 S * 9/1995 Johnson D9/434
D375,459 S * 11/1996 Tipp D9/434
D377,313 S * 1/1997 Tipp D9/434

D389,404 S * 1/1998 Tipp D9/434
D413,800 S * 9/1999 Caparros et al. D9/752
D478,508 S * 8/2003 Kumakura D9/451
D497,255 S * 10/2004 Scola D3/328
D528,415 S * 9/2006 Tuddenham D9/434
D587,569 S * 3/2009 Eveleth D9/434

* cited by examiner

Primary Examiner—Susan Bennett Hattan

(74) *Attorney, Agent, or Firm*—Barnes & Thornburg LLP

(57) **CLAIM**

The ornamental design for a bag holder, as shown and described.

DESCRIPTION

FIG. 1 is a perspective view of the bag holder according to my invention;

FIG. 2 is a front elevational view of the bag holder illustrated in FIG. 1;

FIG. 3 is a rear elevational view of the bag holder illustrated in FIG. 1;

FIG. 4 is a left side elevational view of the bag holder illustrated in FIG. 1;

FIG. 5 is a right side elevational view of the bag holder illustrated in FIG. 1;

FIG. 6 is a top plan view of the bag holder illustrated in FIG. 1; and,

FIG. 7 is a bottom plan view of the bag holder illustrated in FIG. 1.

1 Claim, 7 Drawing Sheets

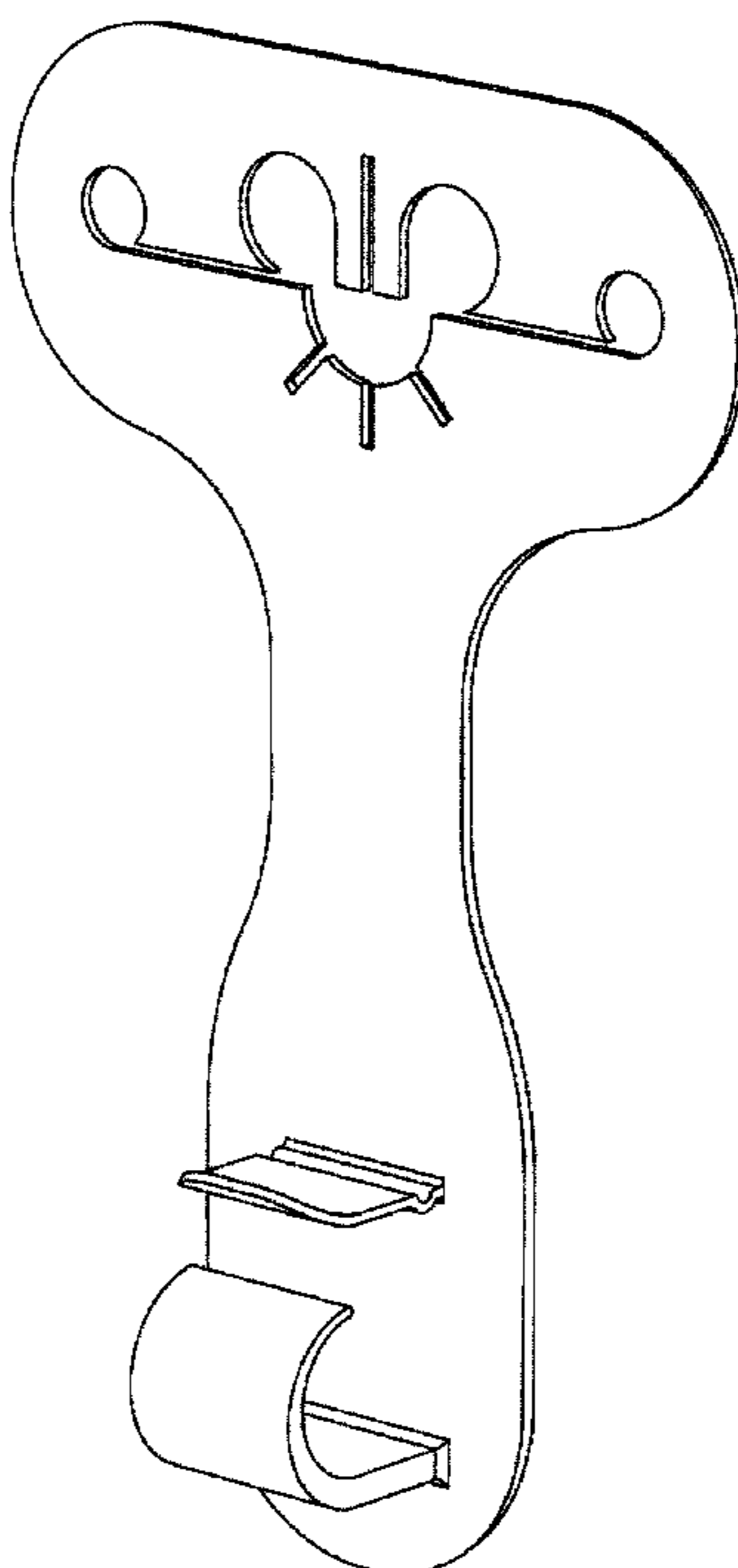

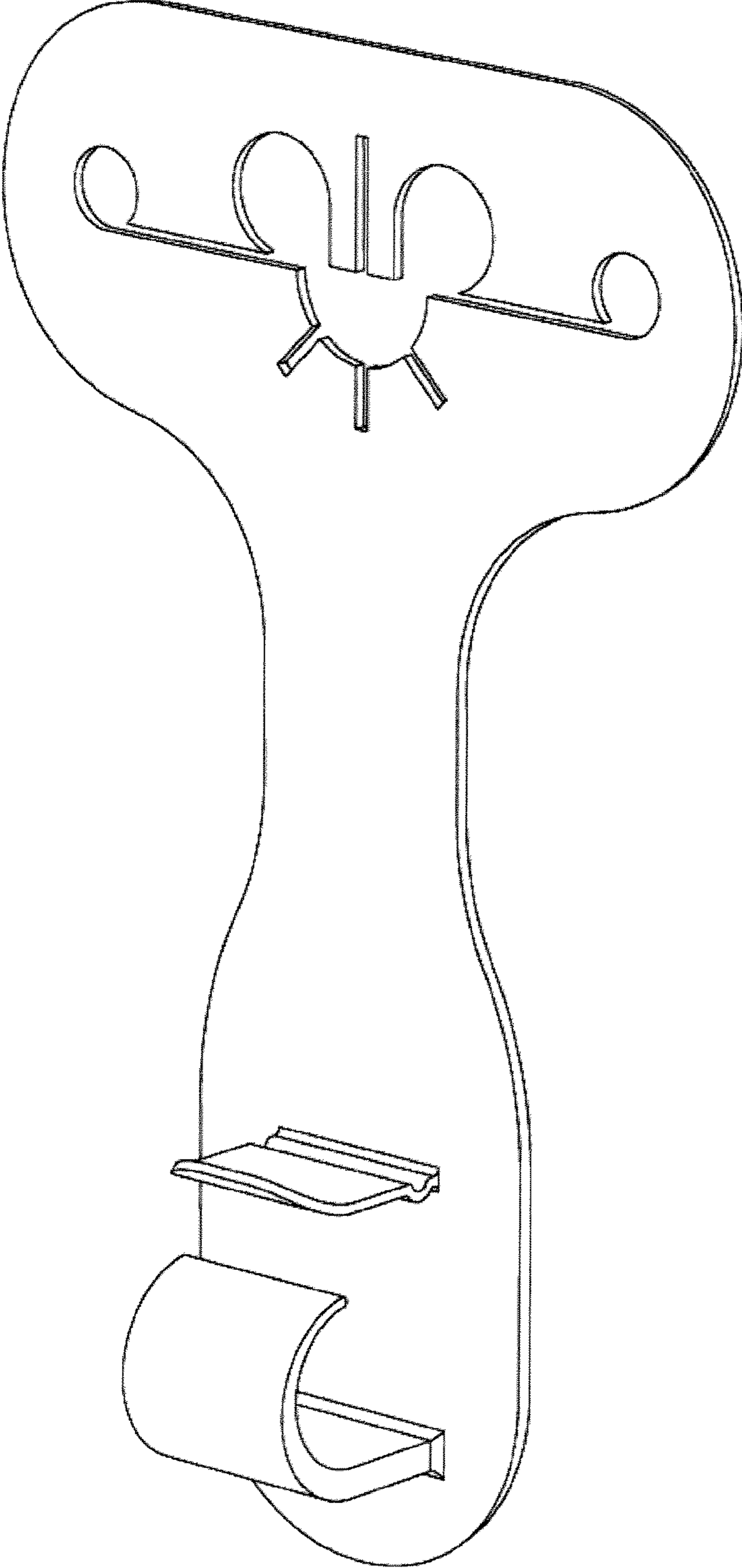

FIG. 1

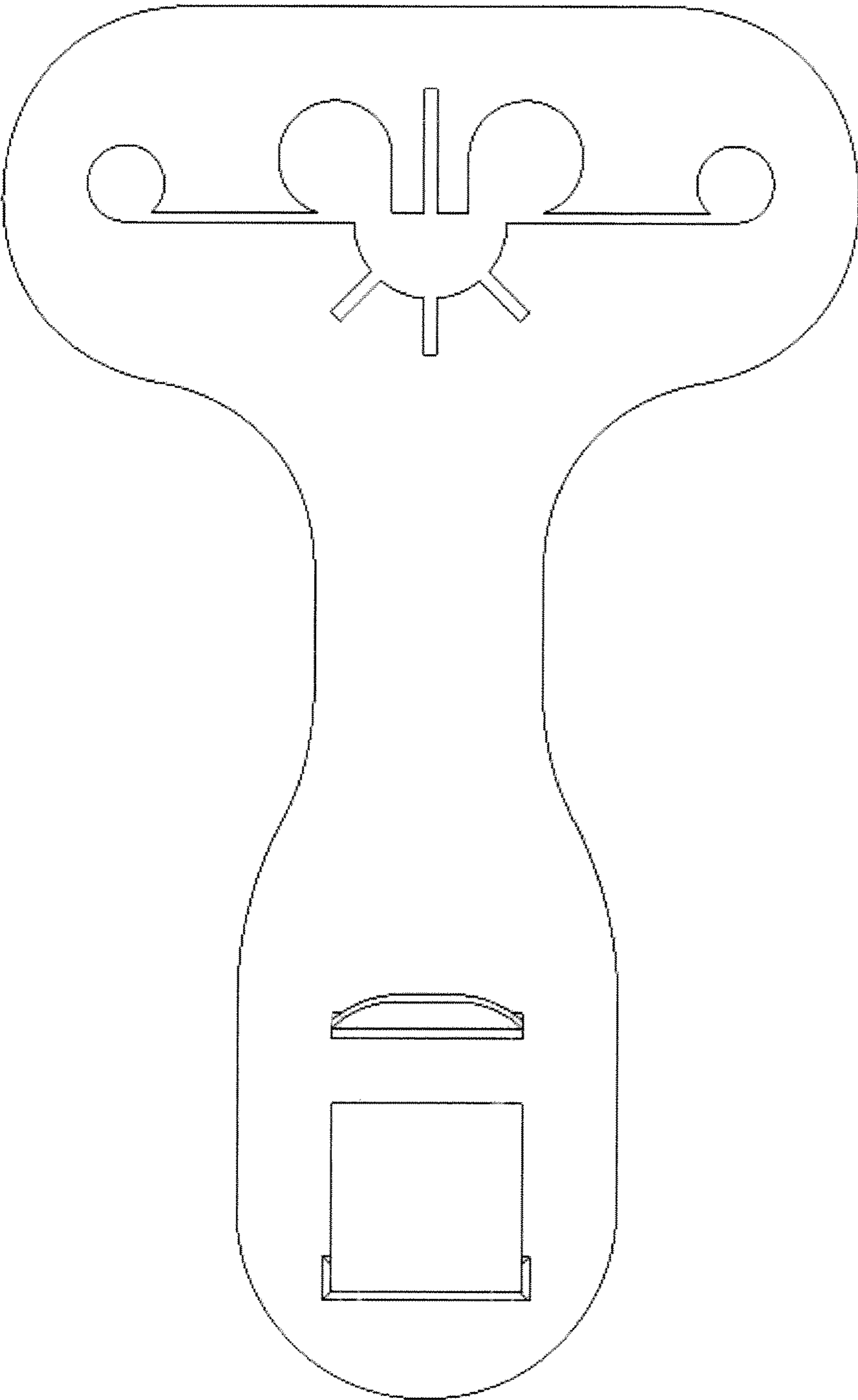

FIG. 2

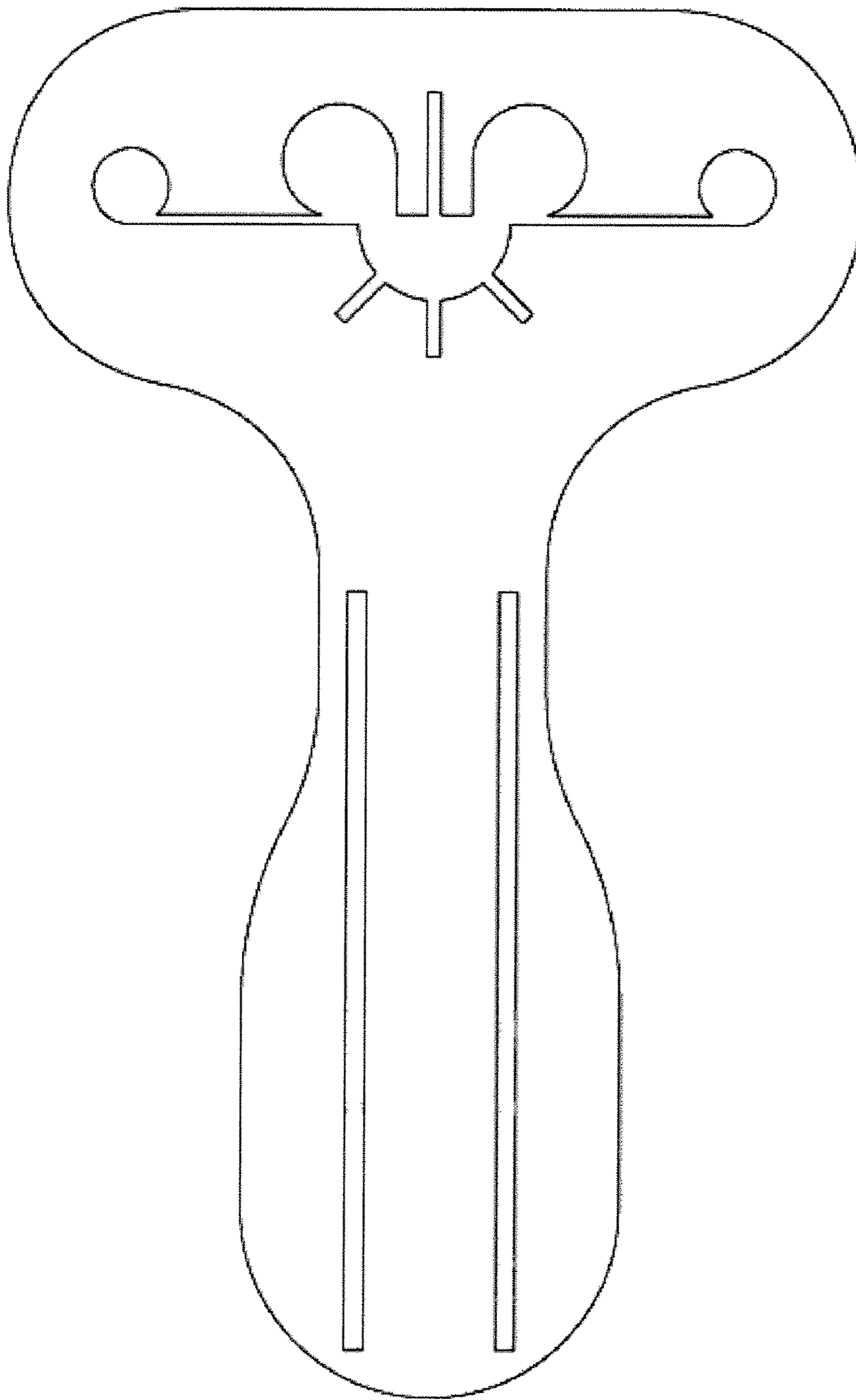

FIG. 3

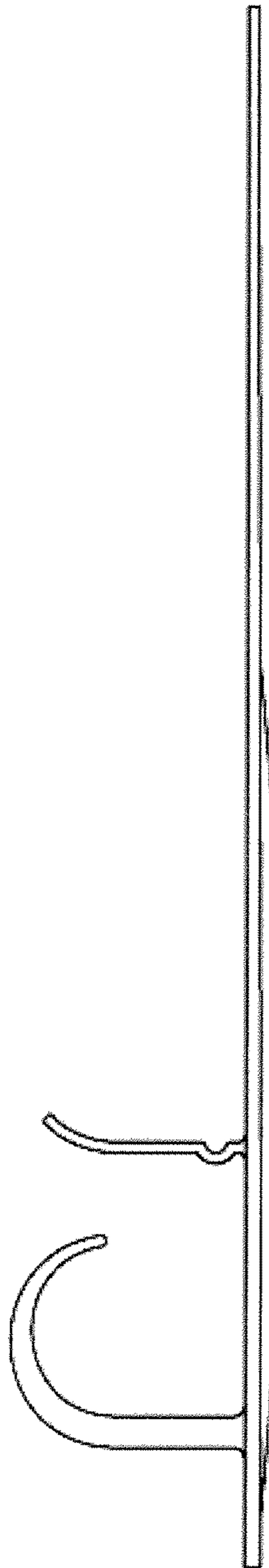

FIG. 4

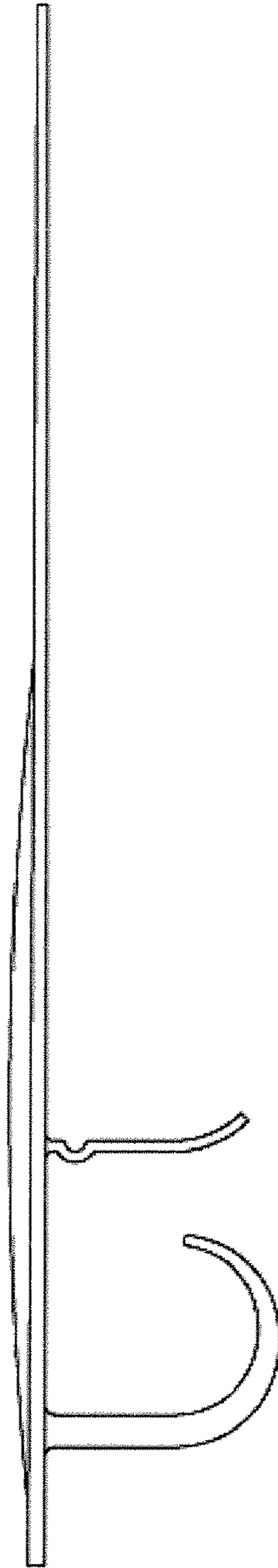

FIG. 5

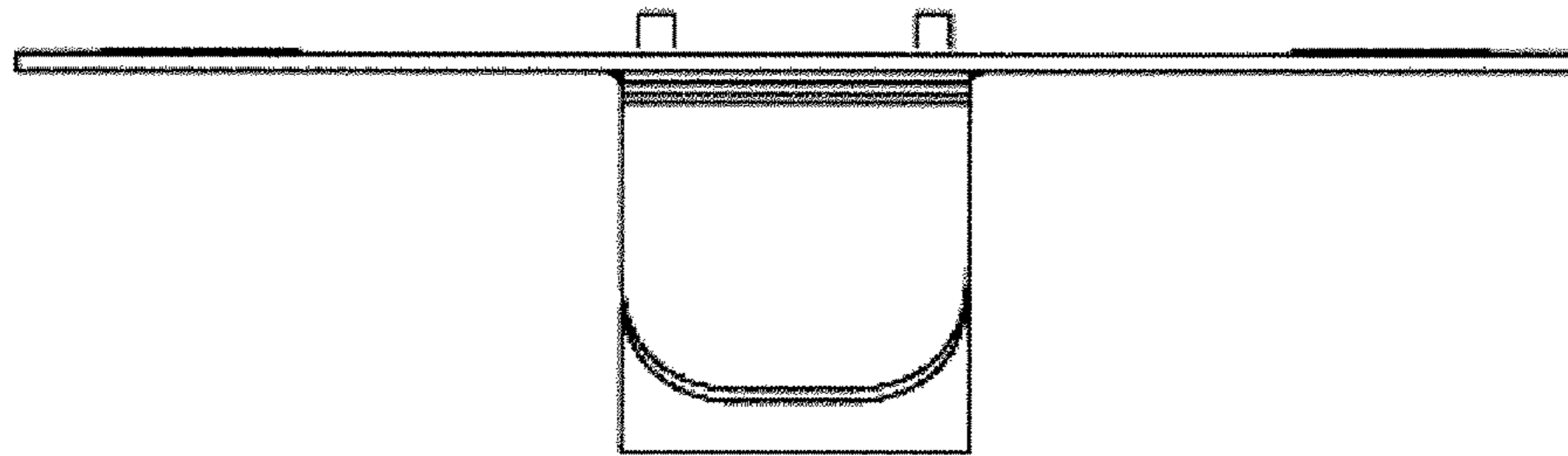

FIG. 6

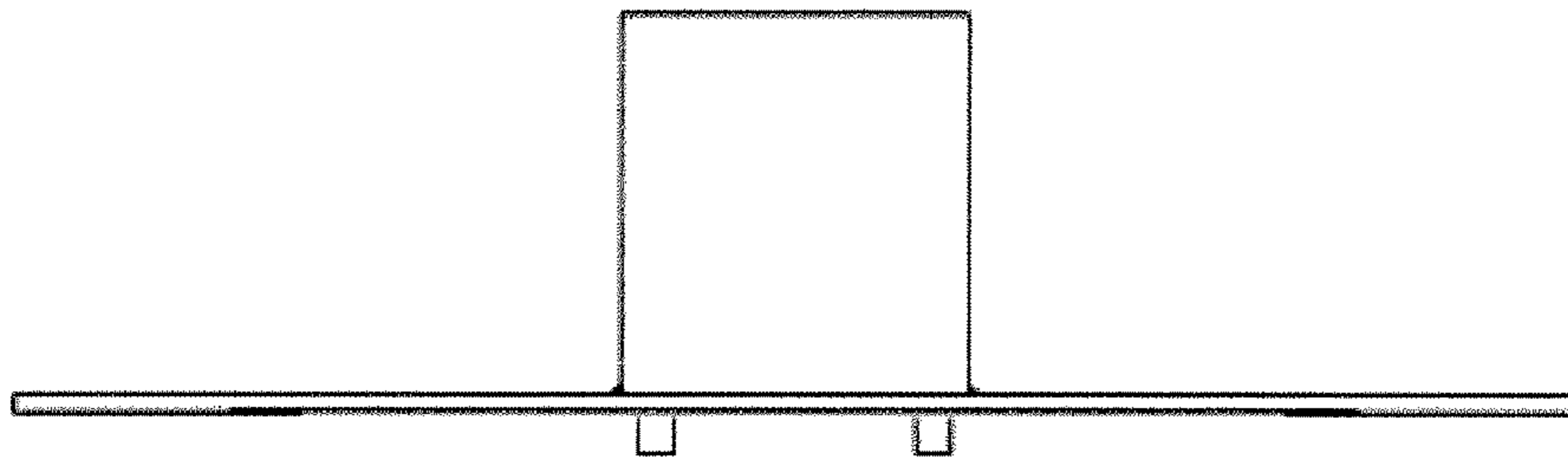

FIG. 7