



US00D603222S

(12) **United States Design Patent**
Krueger et al.

(10) **Patent No.:** **US D603,222 S**

(45) **Date of Patent:** **** Nov. 3, 2009**

(54) **RESERVING MICROWAVE CONTAINER
COMPRISING A BOWL WITH A LID**

(75) Inventors: **Kevin Krueger**, St. Louis, MO (US);
Jason Shuey, St. Louis, MO (US); **Tim
Cimmerer**, St. Louis, MO (US); **Satya
Garg**, St. Louis, MO (US)

(73) Assignee: **Anchor Packaging, Inc.**, St. Louis, MO
(US)

(**) Term: **14 Years**

(21) Appl. No.: **29/273,019**

(22) Filed: **Feb. 23, 2007**

(51) **LOC (9) Cl.** **07-01**

(52) **U.S. Cl.** **D7/538; D7/542**

(58) **Field of Classification Search** D7/500,
D7/505, 538, 540, 542, 545, 602, 608, 629,
D7/656; D9/414, 424, 428, 429; 220/4.21,
220/574, 573.1, 573.5; 219/725

See application file for complete search history.

(56) **References Cited**

U.S. PATENT DOCUMENTS

3,360,153	A *	12/1967	Wheaton, Jr.	220/4.21
D323,097	S *	1/1992	Picozza	D7/542
D324,324	S *	3/1992	Picozza	D7/565
D337,051	S *	7/1993	Harbeke	D9/424
D352,423	S *	11/1994	Laib	D7/538
D426,427	S *	6/2000	Rubbright et al.	D7/565
6,175,105	B1 *	1/2001	Rubbright et al.	219/725
D454,304	S *	3/2002	Kim et al.	D9/429
D468,202	S *	1/2003	Chou	D9/429
D473,788	S *	4/2003	Chen et al.	D9/428
D551,909	S *	10/2007	Eide et al.	D7/565

* cited by examiner

Primary Examiner—Robert M Spear
Assistant Examiner—Cynthia Underwood

(74) *Attorney, Agent, or Firm*—Gallop, Johnson & Neuman

(57) **CLAIM**

The ornamental design for a reserving microwave container comprising a bowl, lid, and bowl with a lid, as shown and described.

DESCRIPTION

FIG. 1 is a perspective view of a reserving microwave container comprising a bowl with a lid embodying our new design;

FIG. 2 is a front elevation view thereof;

FIG. 3 is a rear elevation view thereof;

FIG. 4 is a left side elevation view thereof;

FIG. 5 is a right side elevation view thereof;

FIG. 6 is a top plan view thereof;

FIG. 7 is a bottom plan view thereof;

FIG. 8 is an exploded perspective view thereof, with the lid detached from the bowl for clarity of illustration;

FIG. 9 is top plan view of the lid thereof;

FIG. 10 is a bottom plan view of the lid thereof;

FIG. 11 is a front elevation view of the lid thereof;

FIG. 12 is a rear elevation view of the lid thereof;

FIG. 13 is a left side elevation view of the lid thereof;

FIG. 14 is a right side elevation view of the lid thereof;

FIG. 15 is a top plan view of the bowl thereof;

FIG. 16 is a bottom plan view of the bowl thereof;

FIG. 17 is a front elevation view of the bowl thereof;

FIG. 18 is a rear elevation view of the bowl thereof;

FIG. 19 is a left side elevation view of the bowl thereof; and,

FIG. 20 is a right side elevation view of the bowl thereof.

The broken lines show a portion of the structure that is not part of the claim.

1 Claim, 18 Drawing Sheets

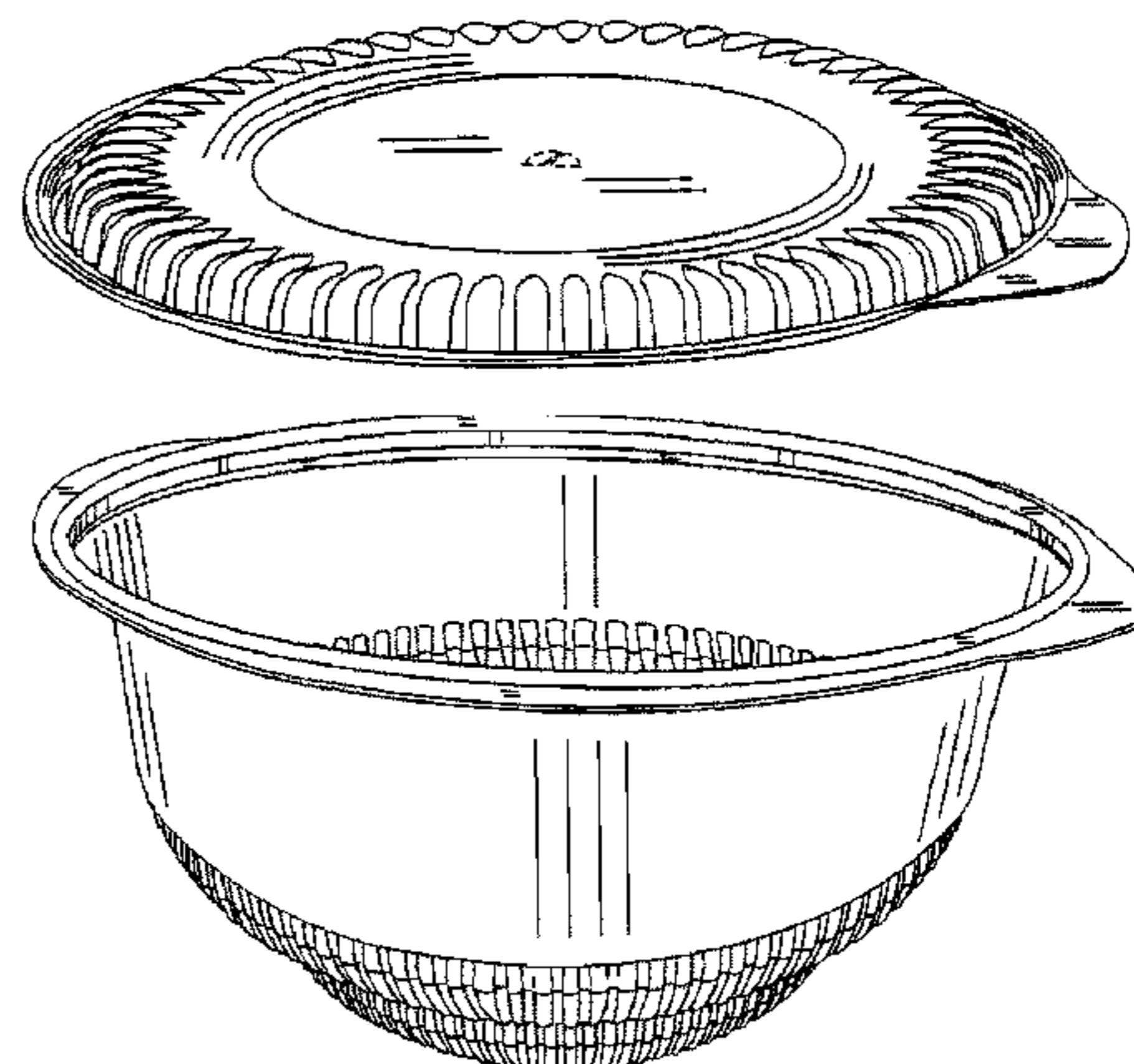
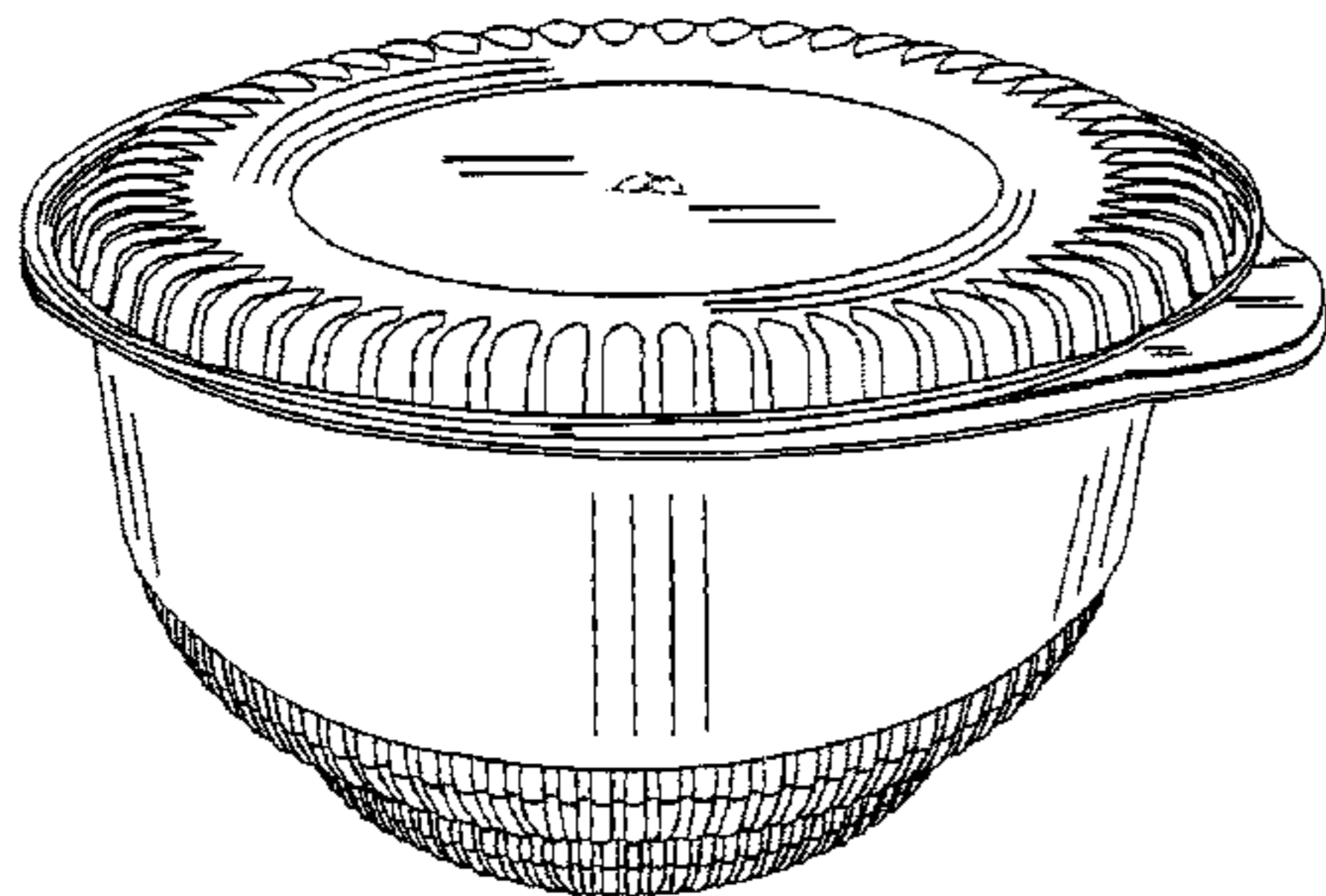

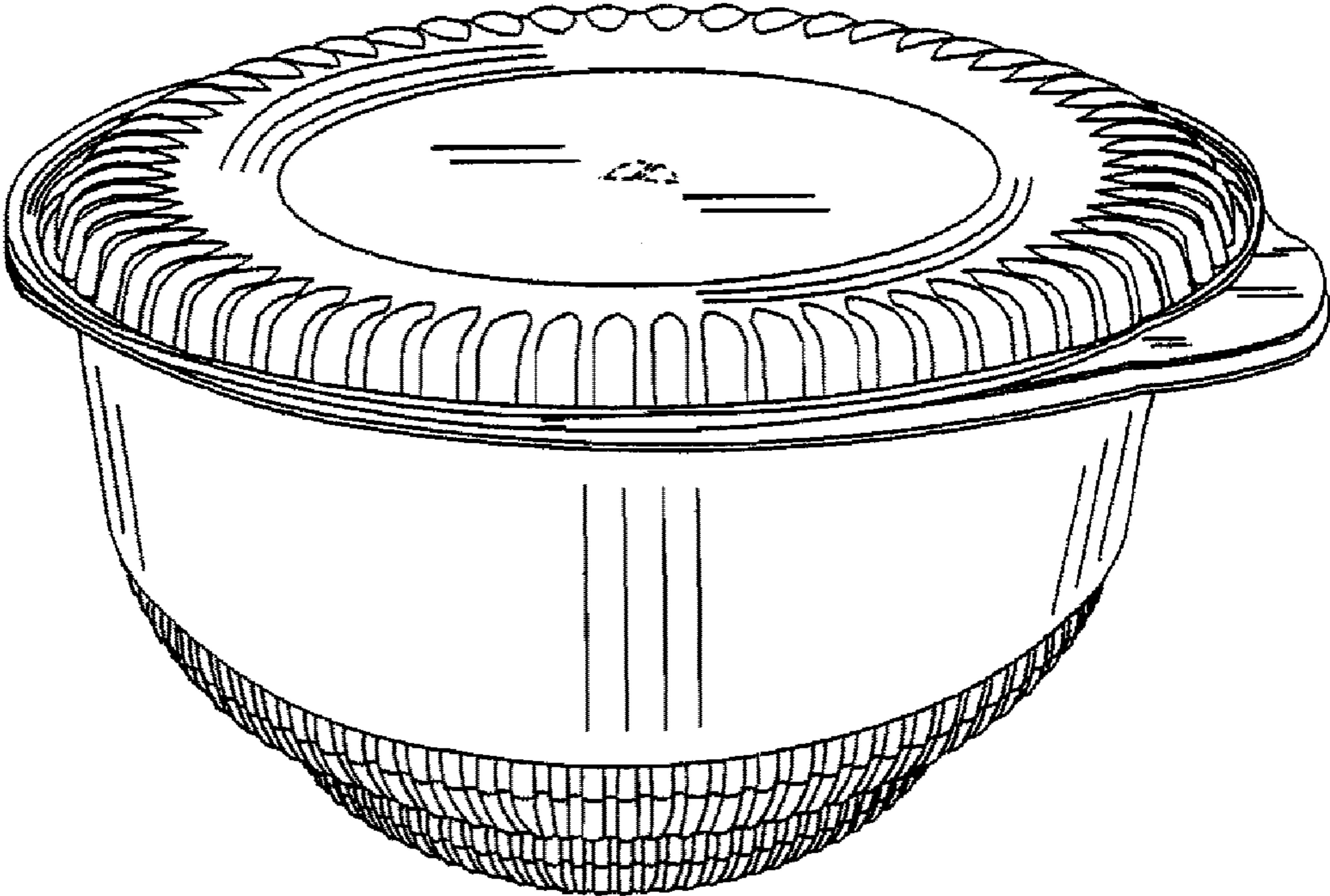

FIG 1

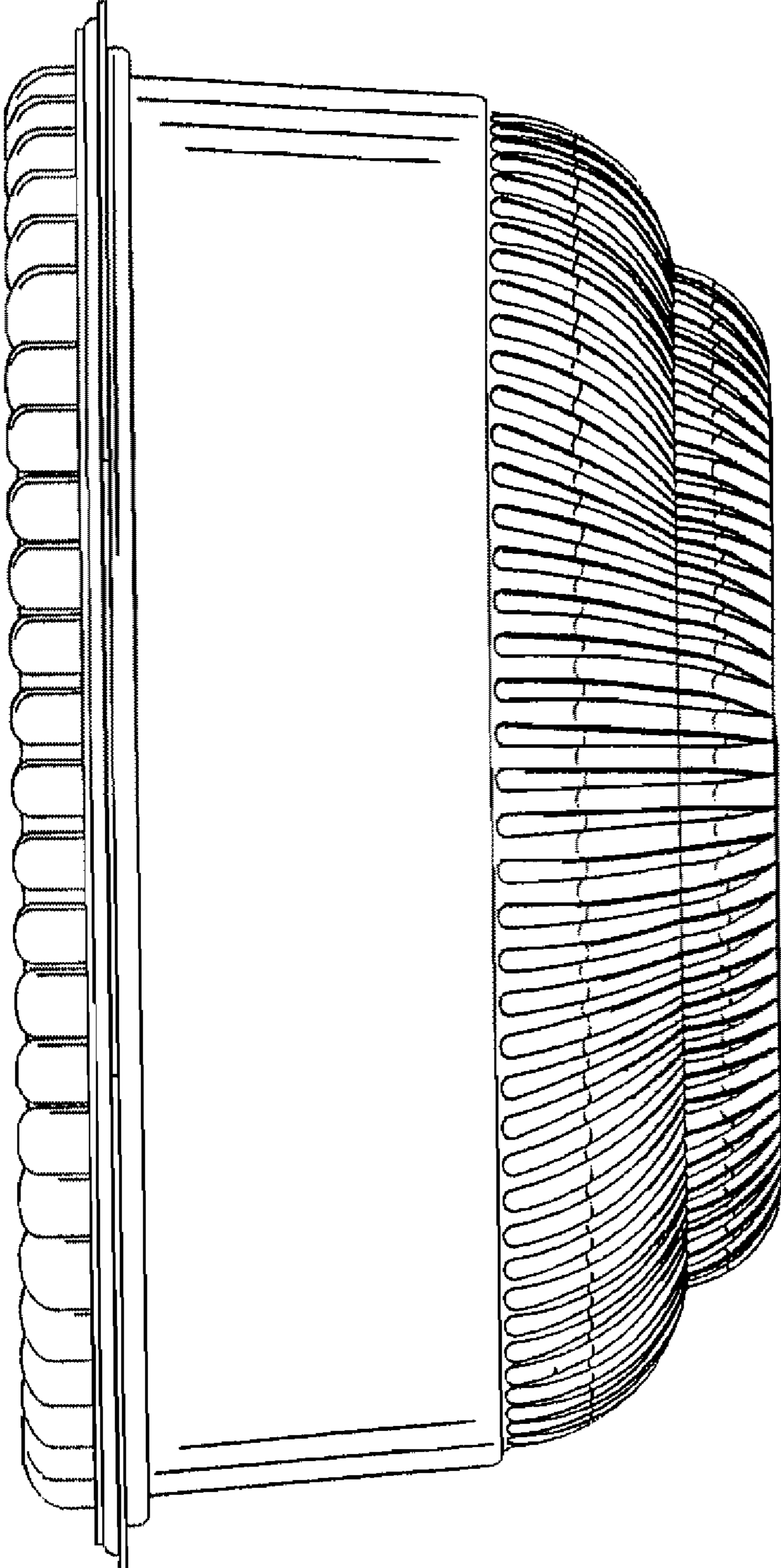

FIG. 2

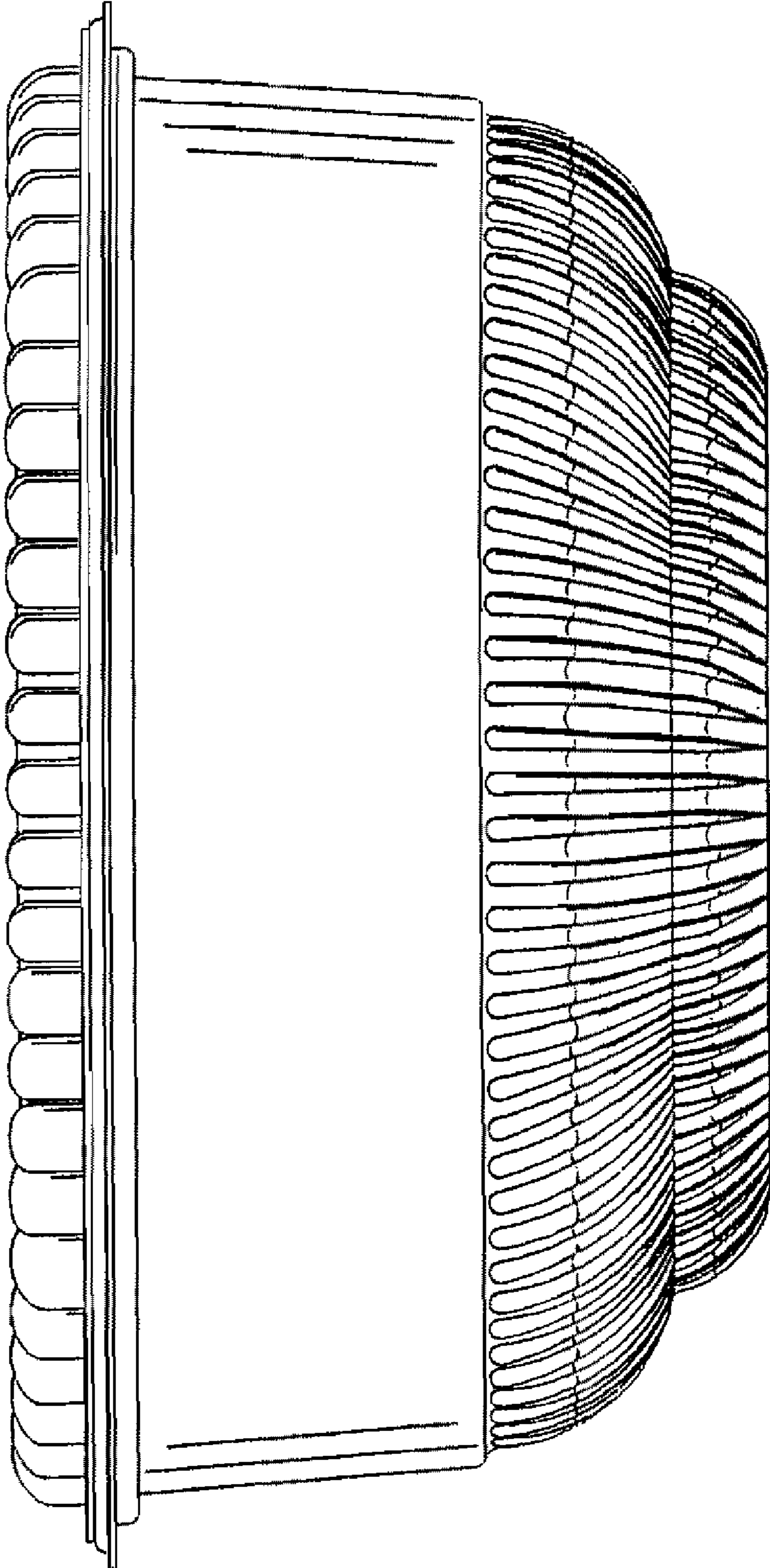

FIG. 3

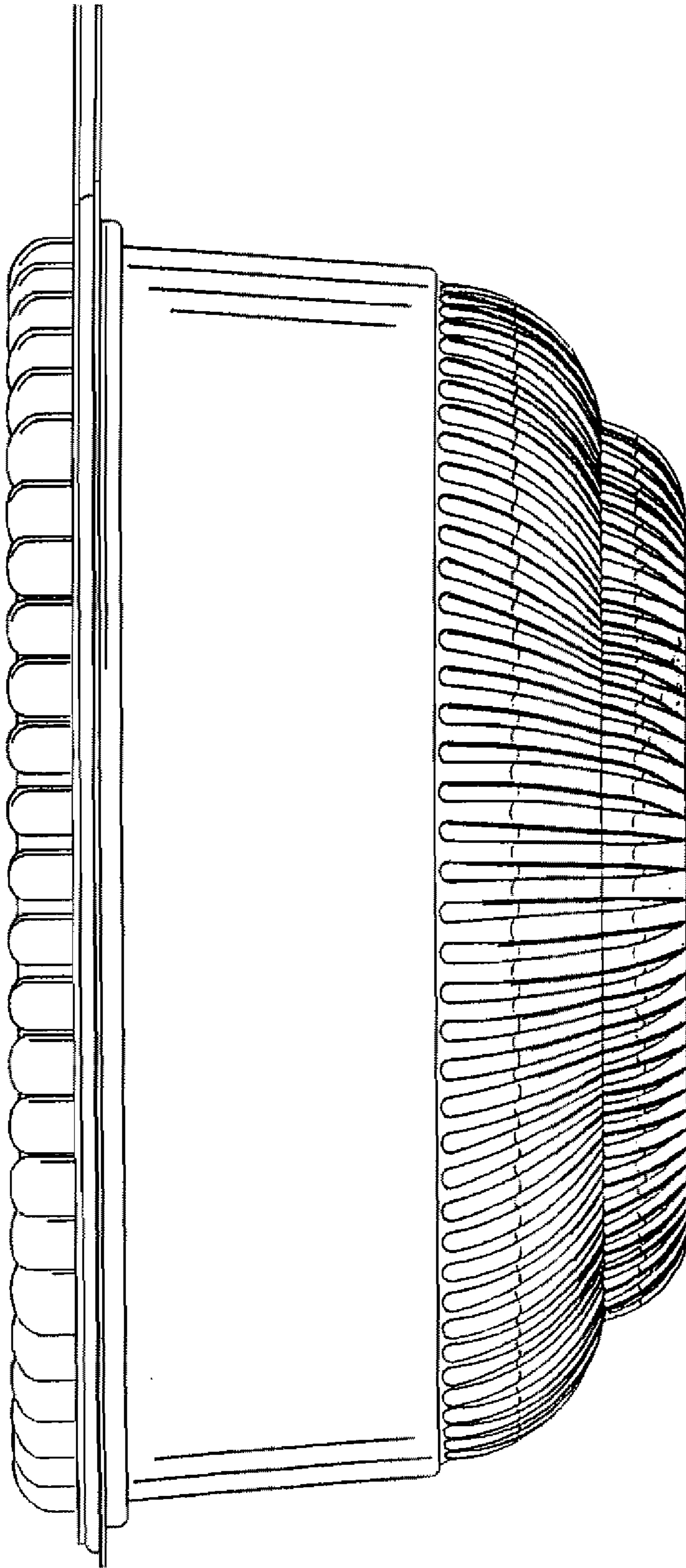

FIG. 4

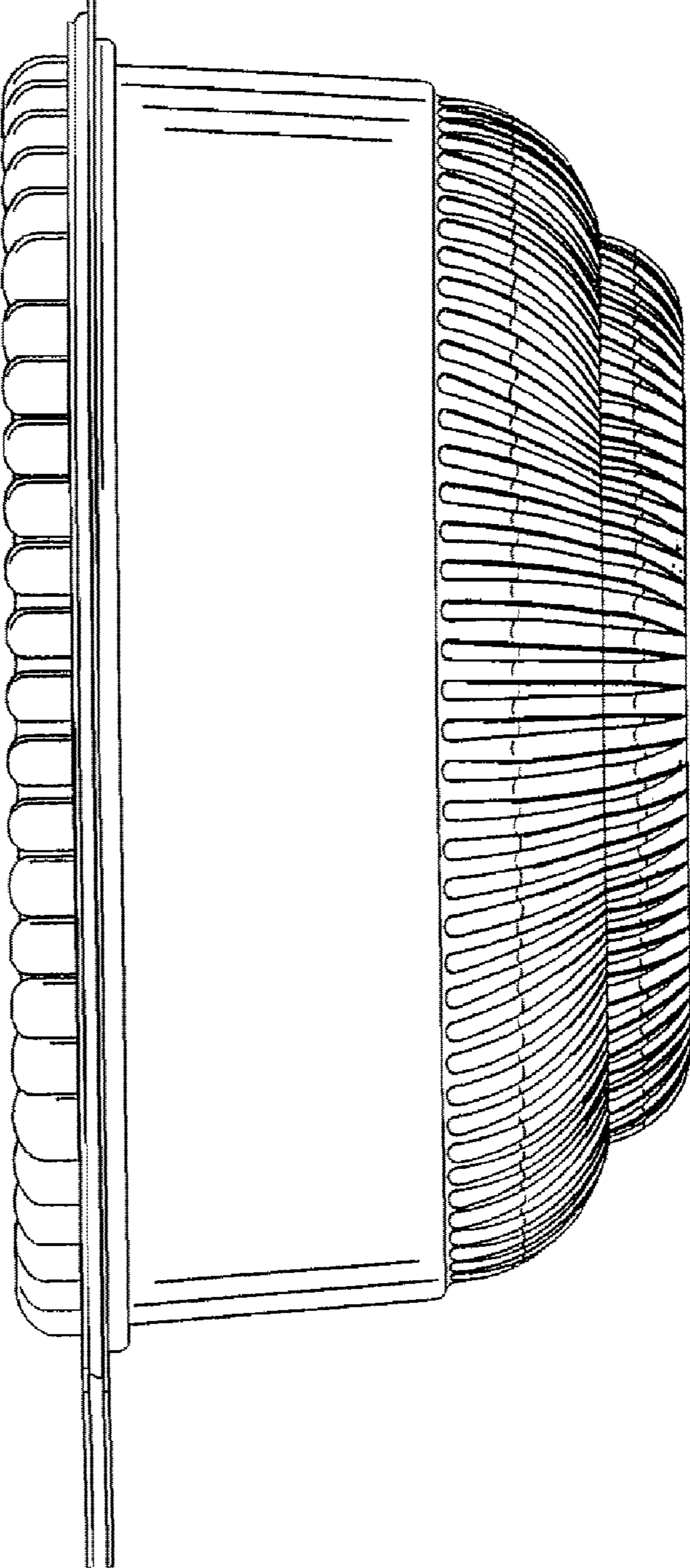

FIG. 5

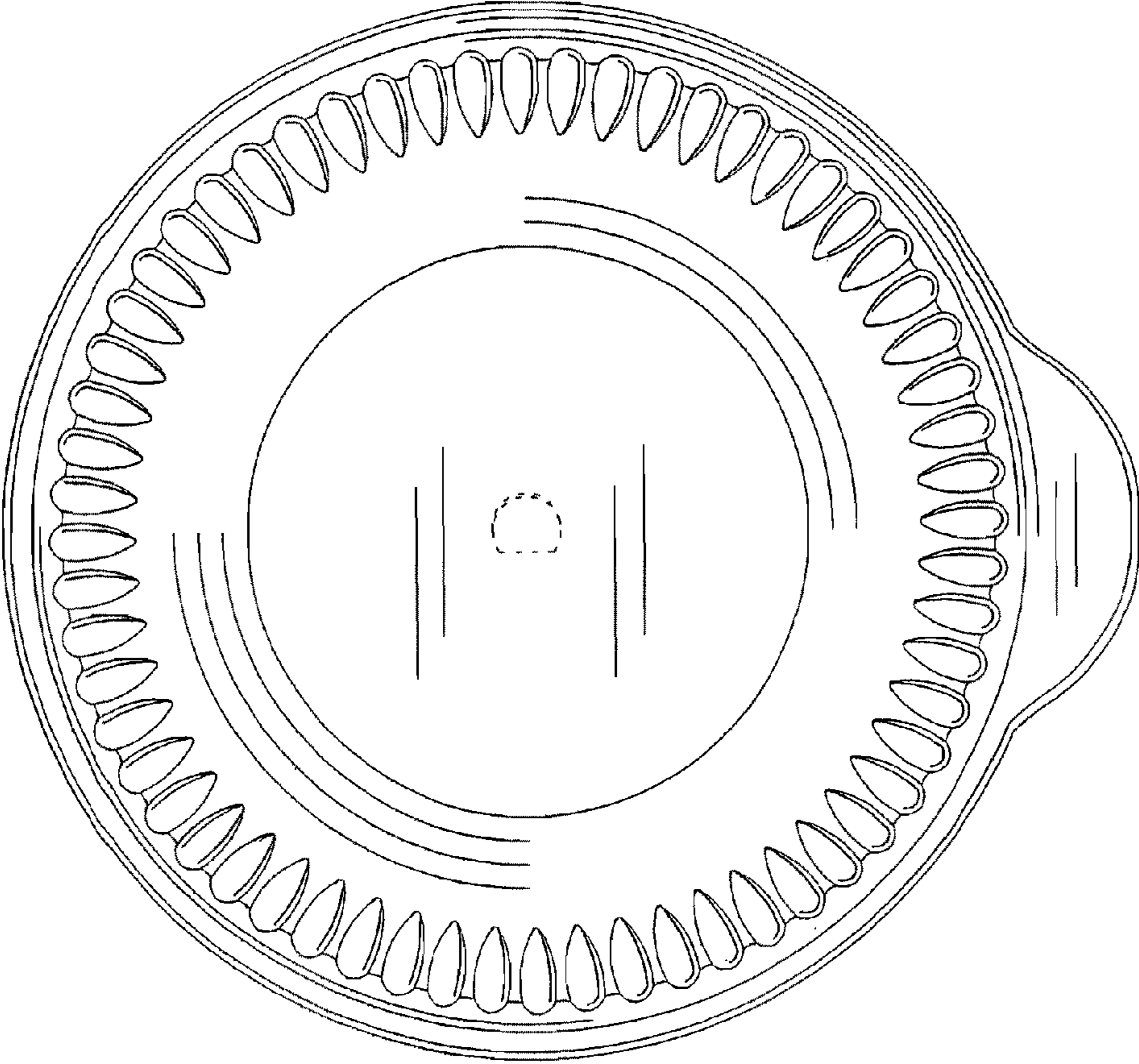

FIG. 6

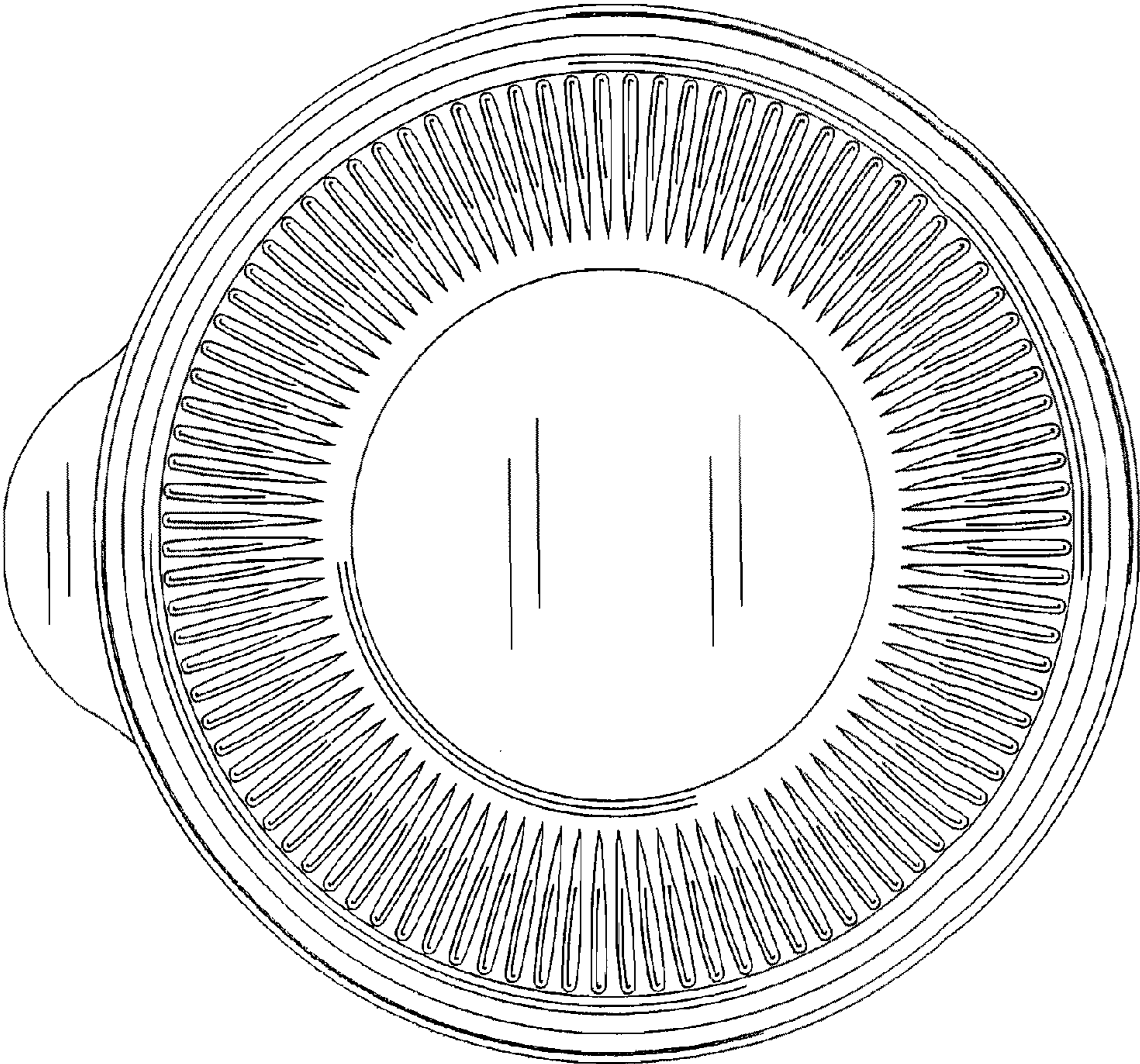

FIG. 7

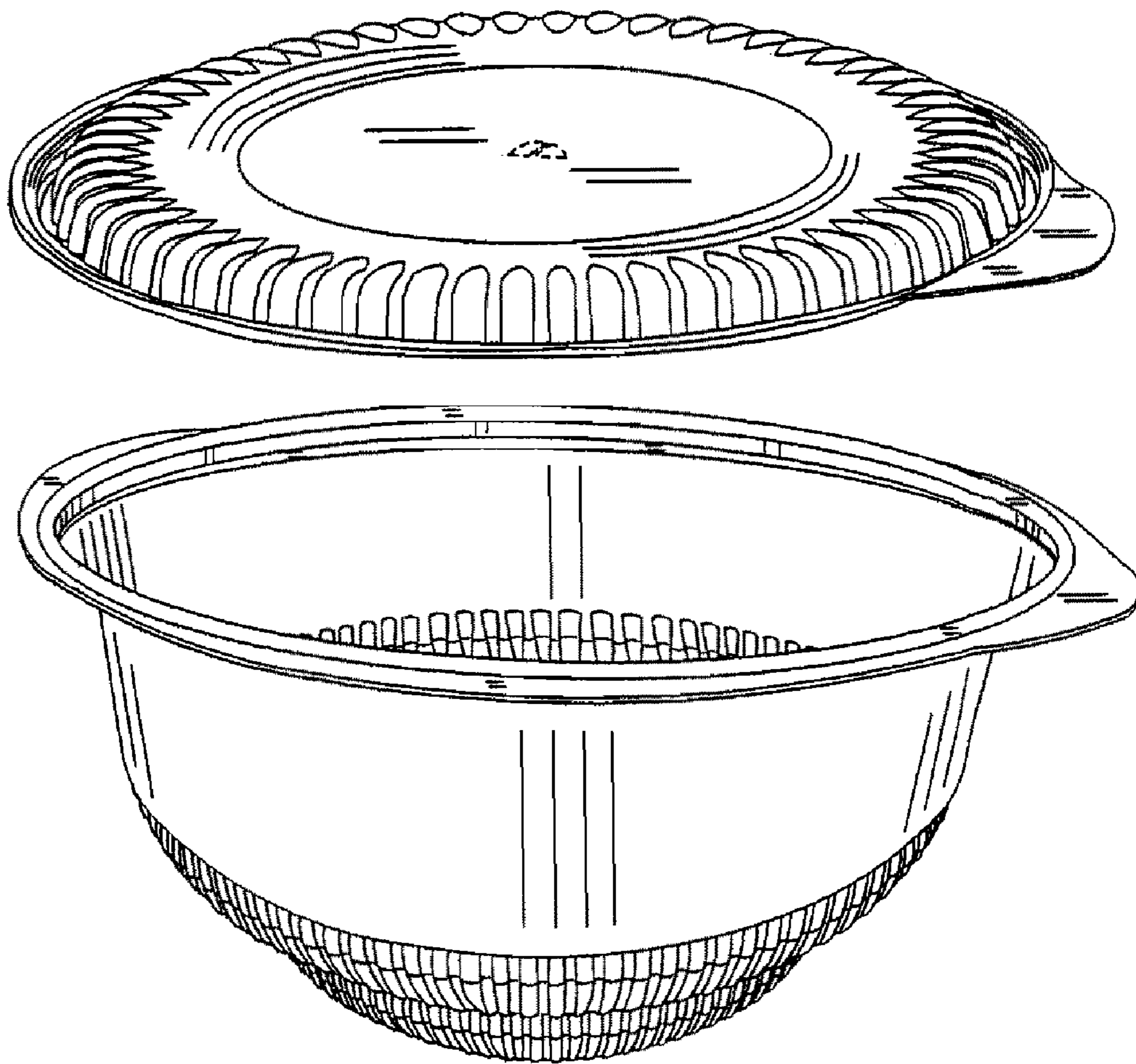

FIG 8

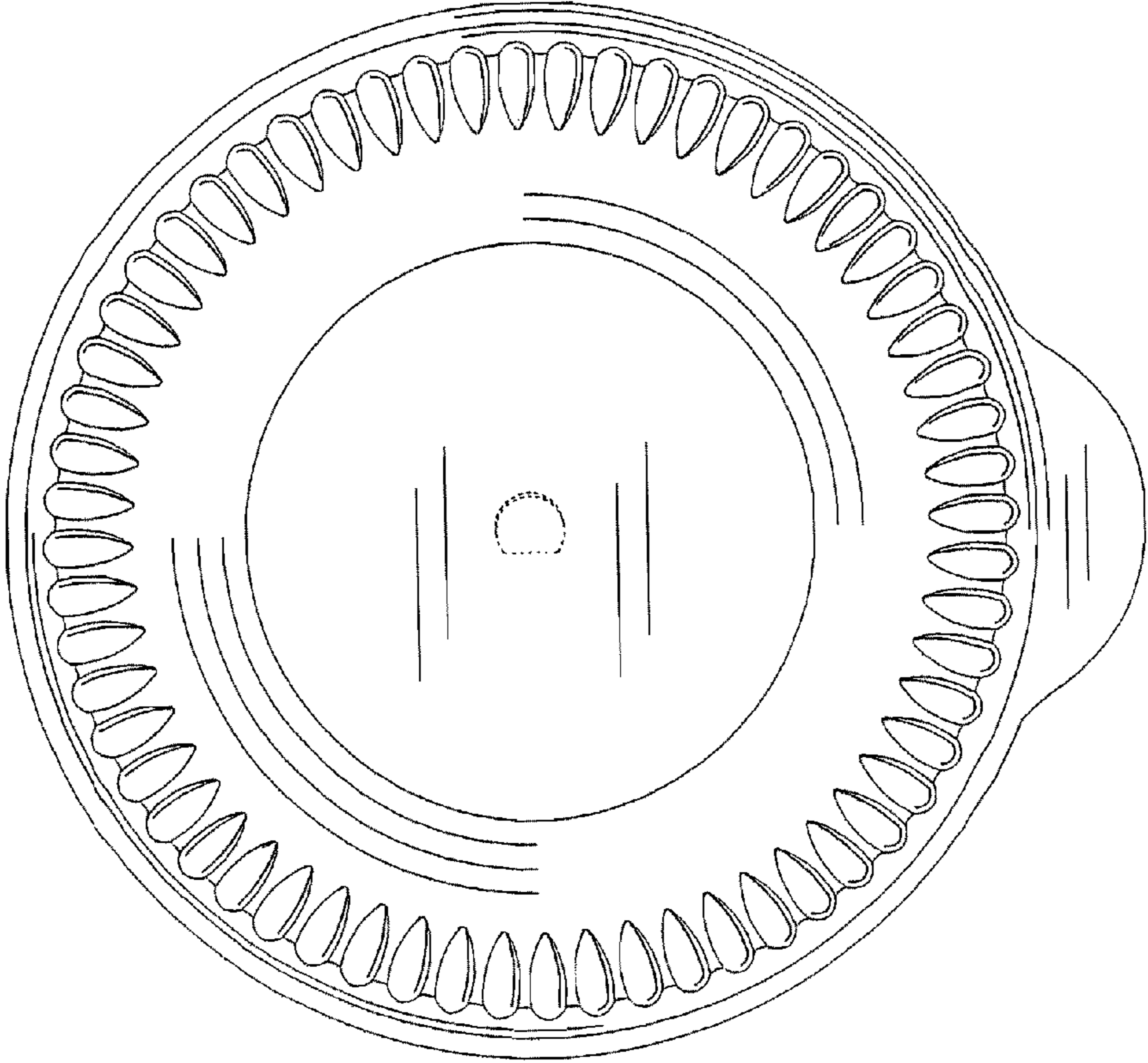

FIG. 9

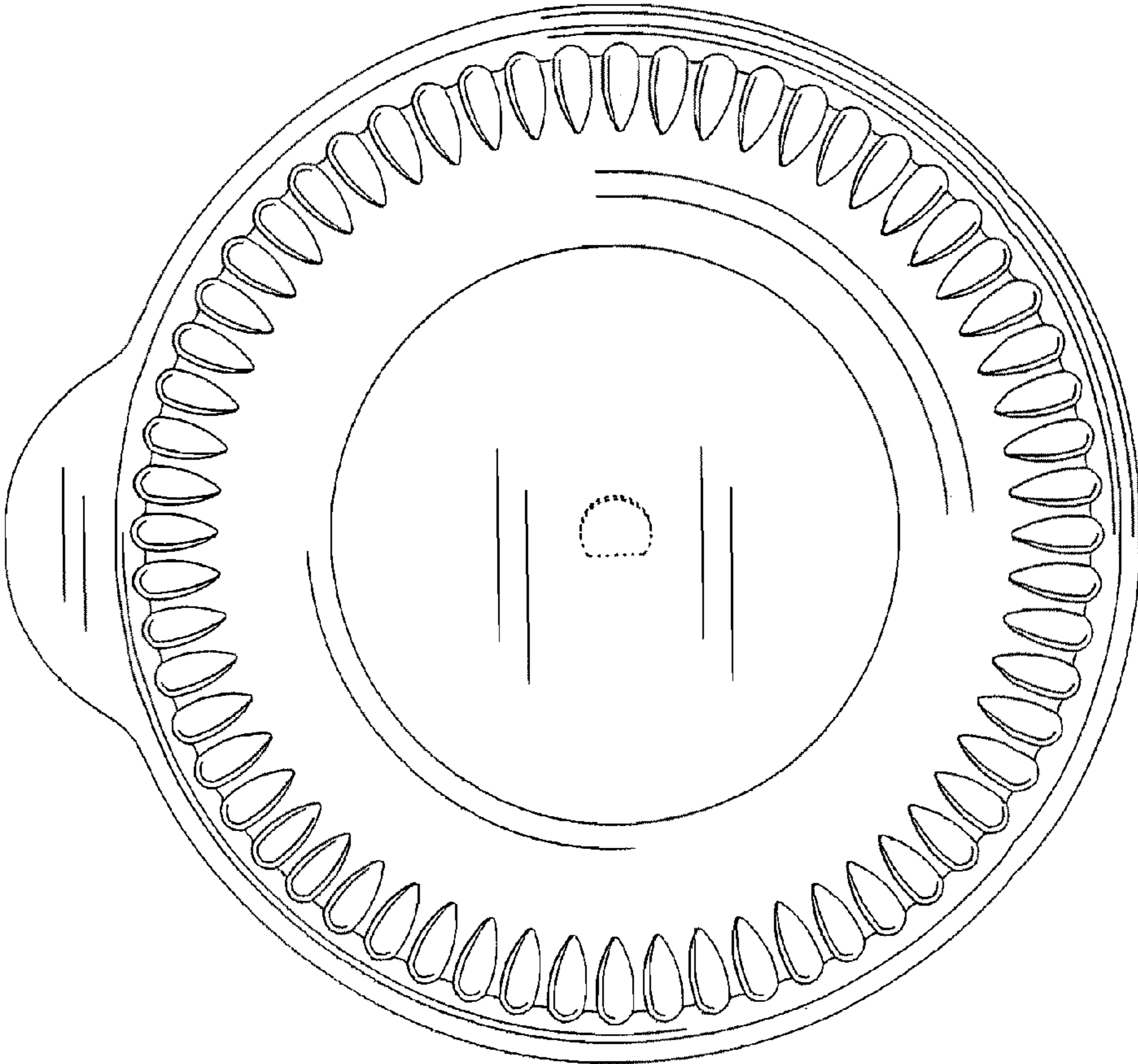

FIG. 10

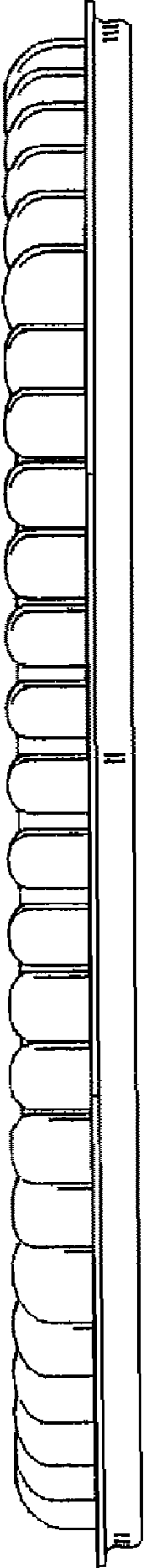

FIG. 11

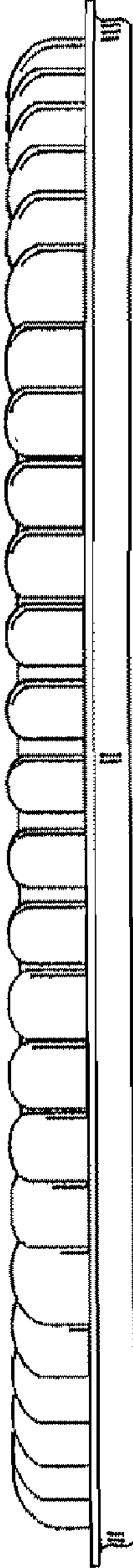

FIG. 12

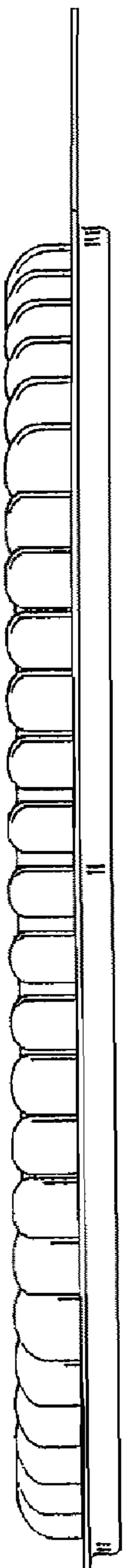

FIG. 13

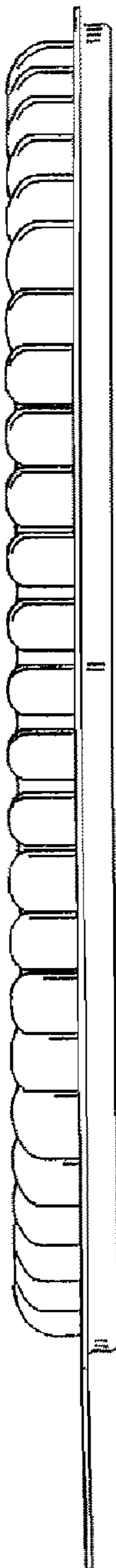

FIG. 14

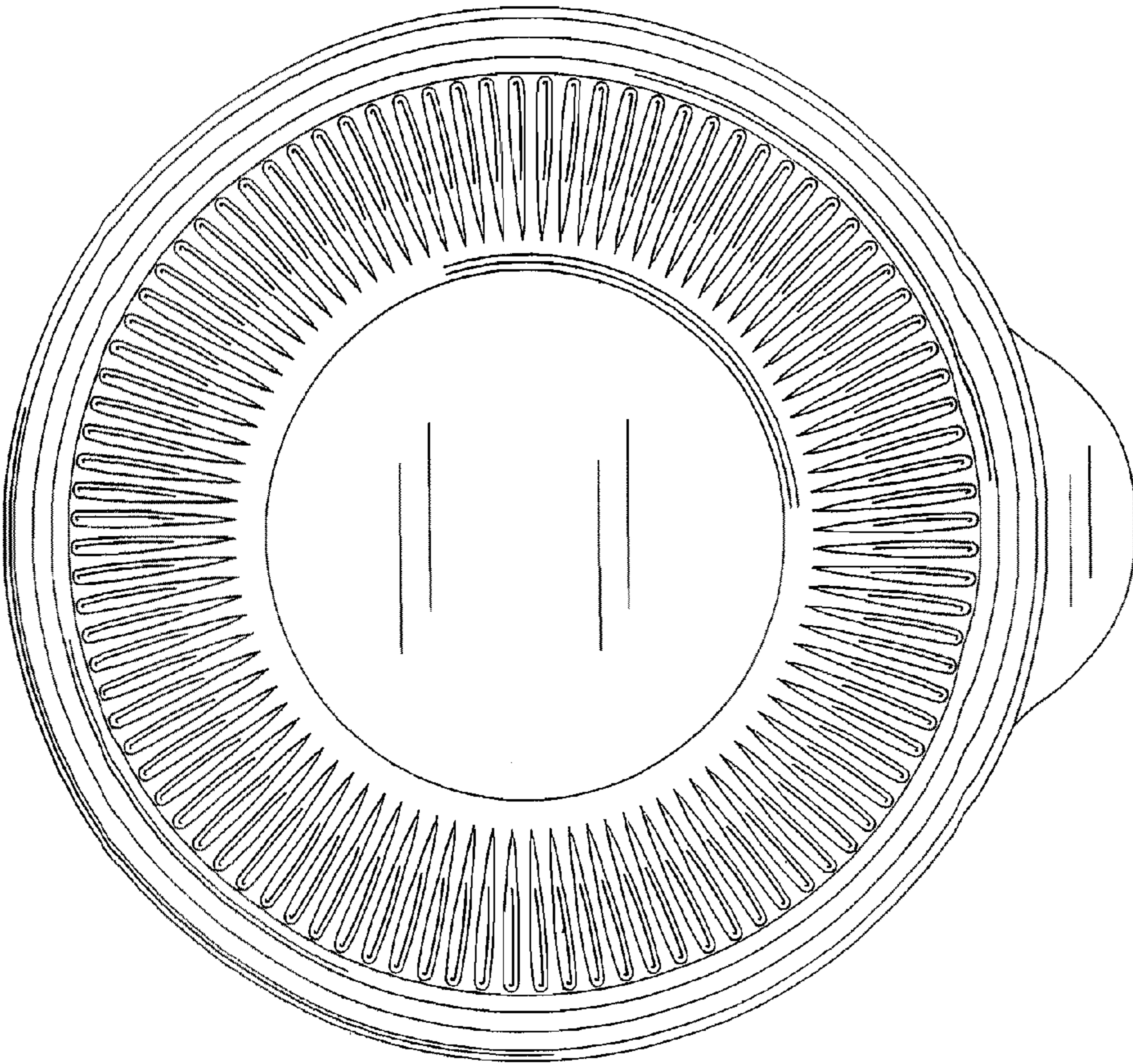

FIG. 15

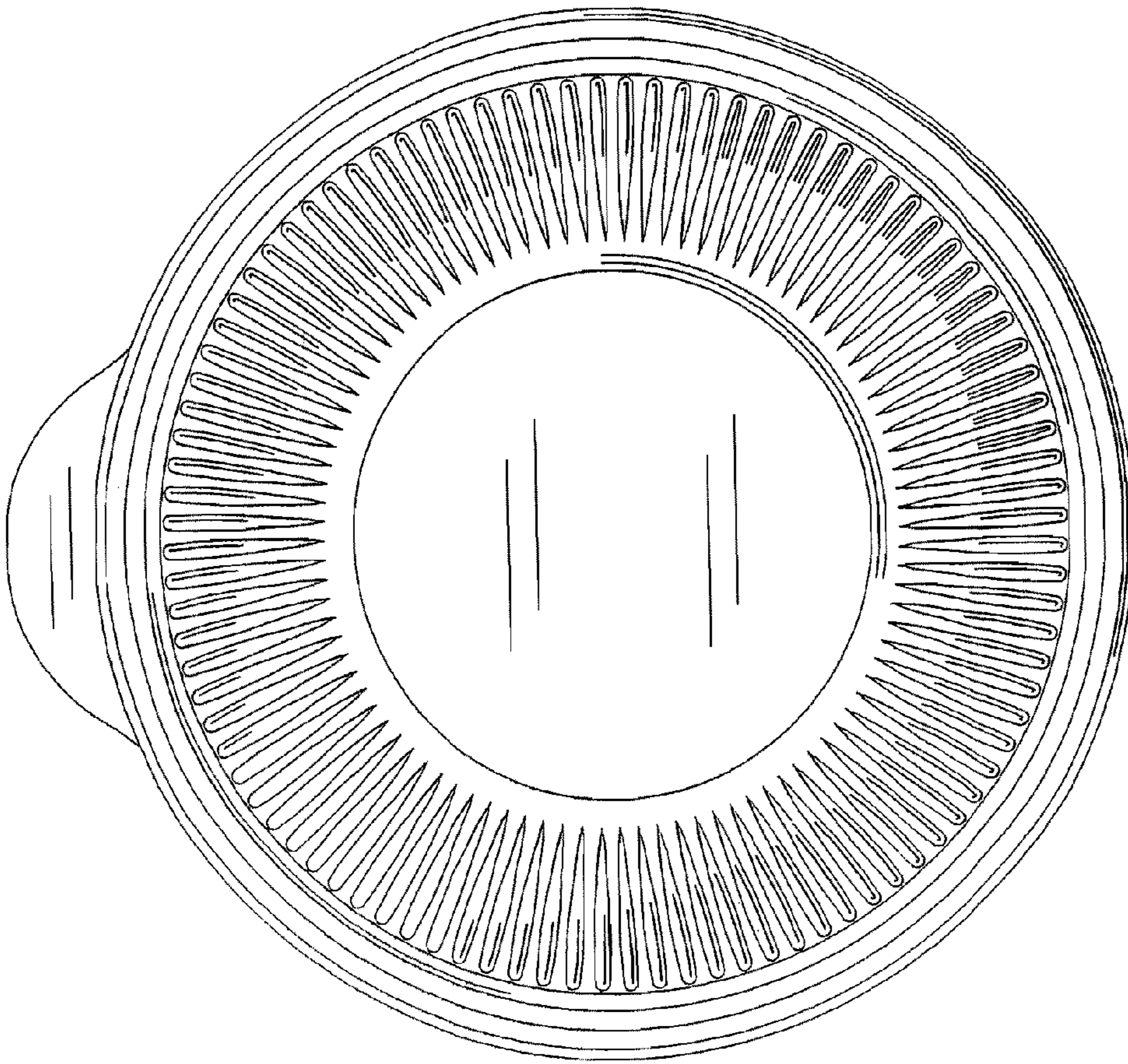

FIG. 16

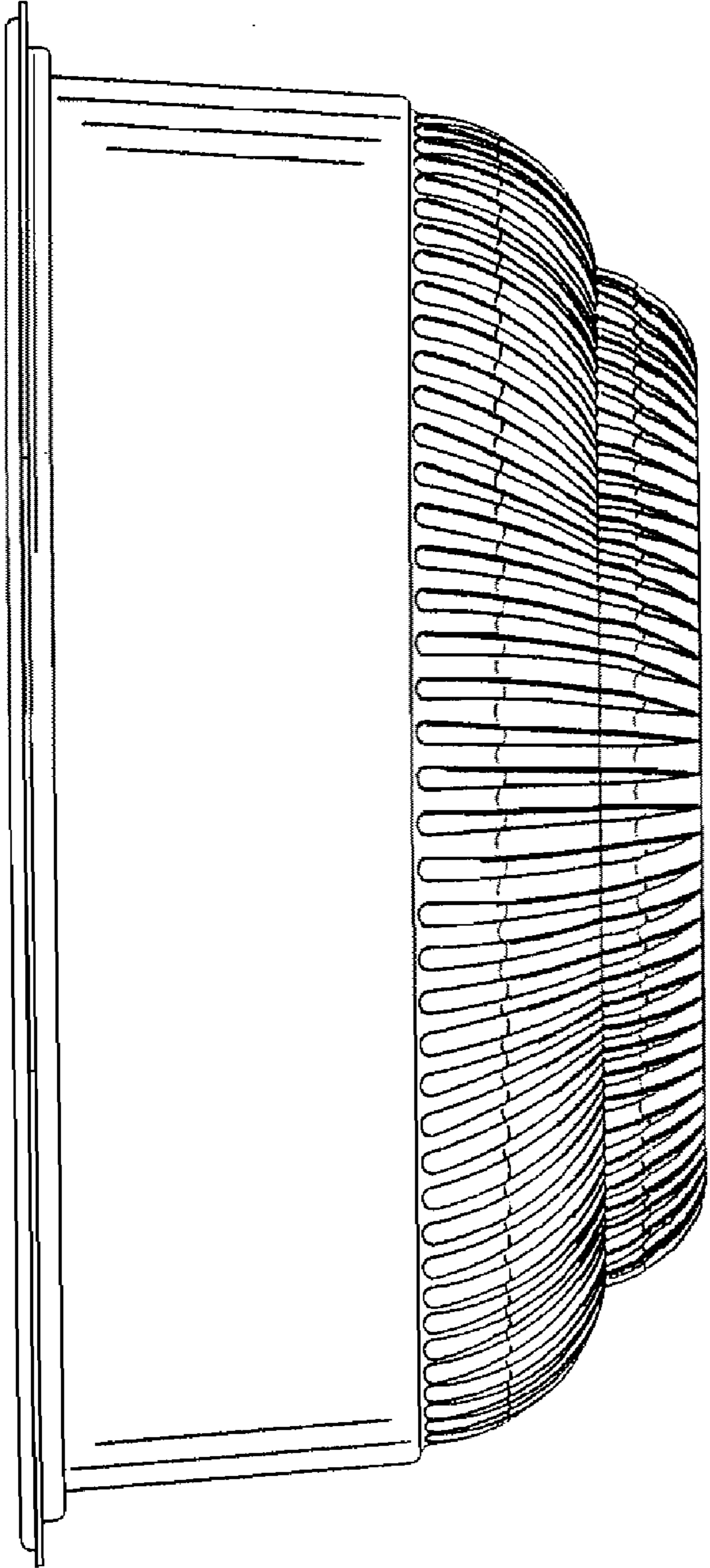

FIG. 17

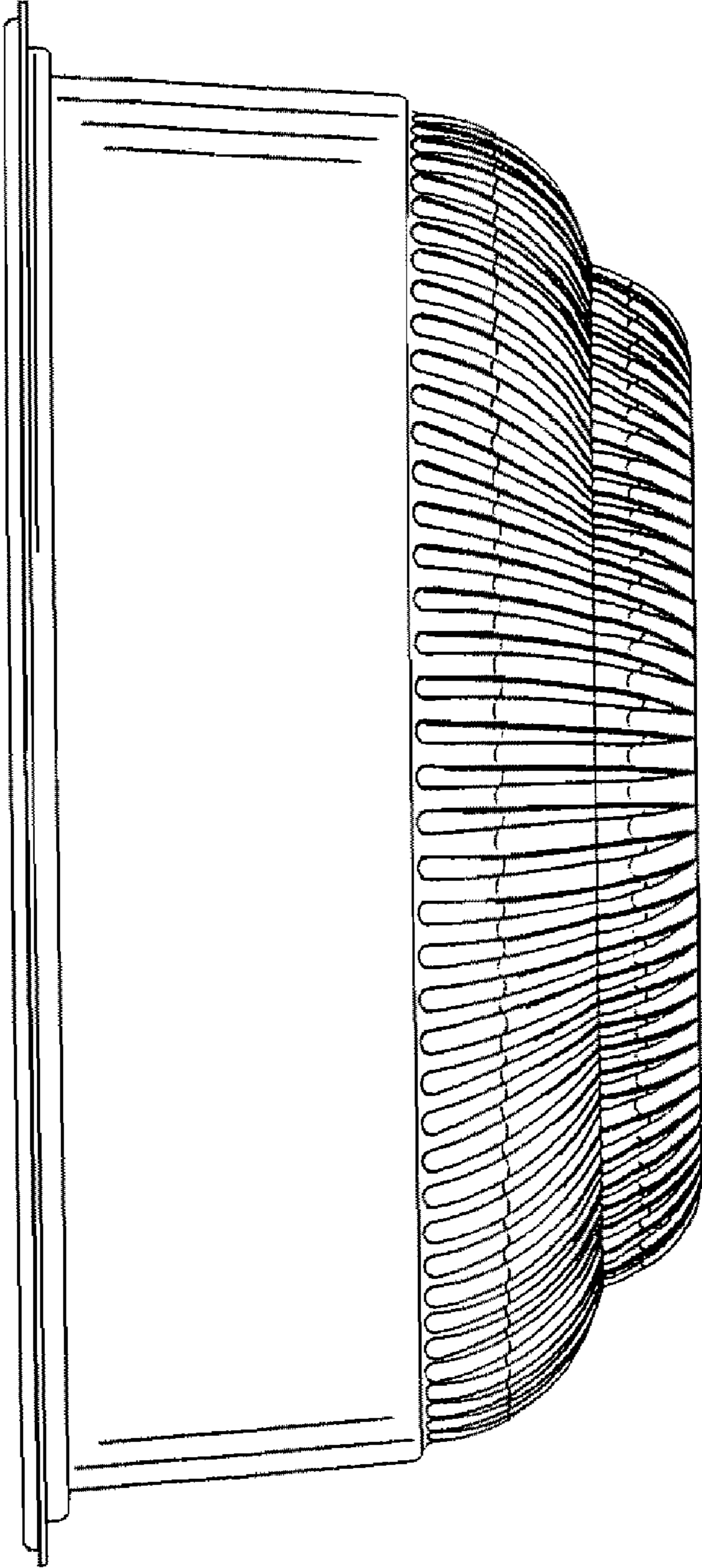

FIG. 18

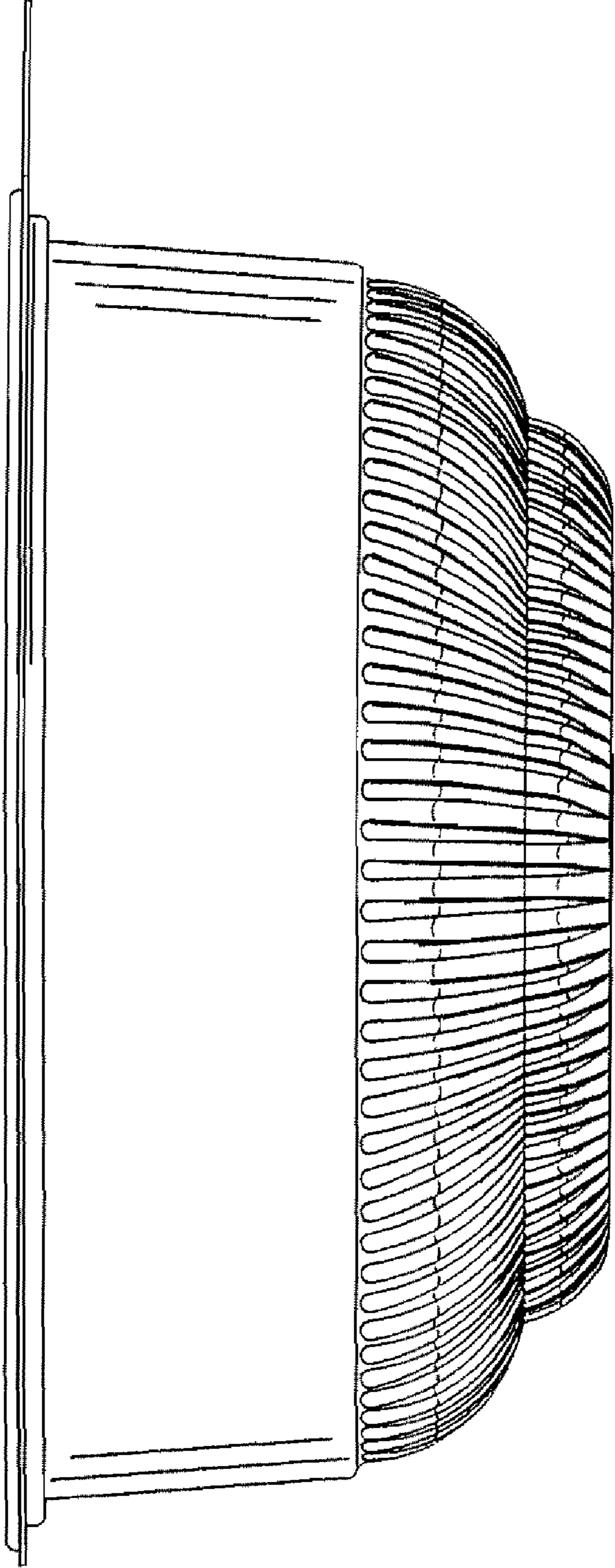

FIG. 19

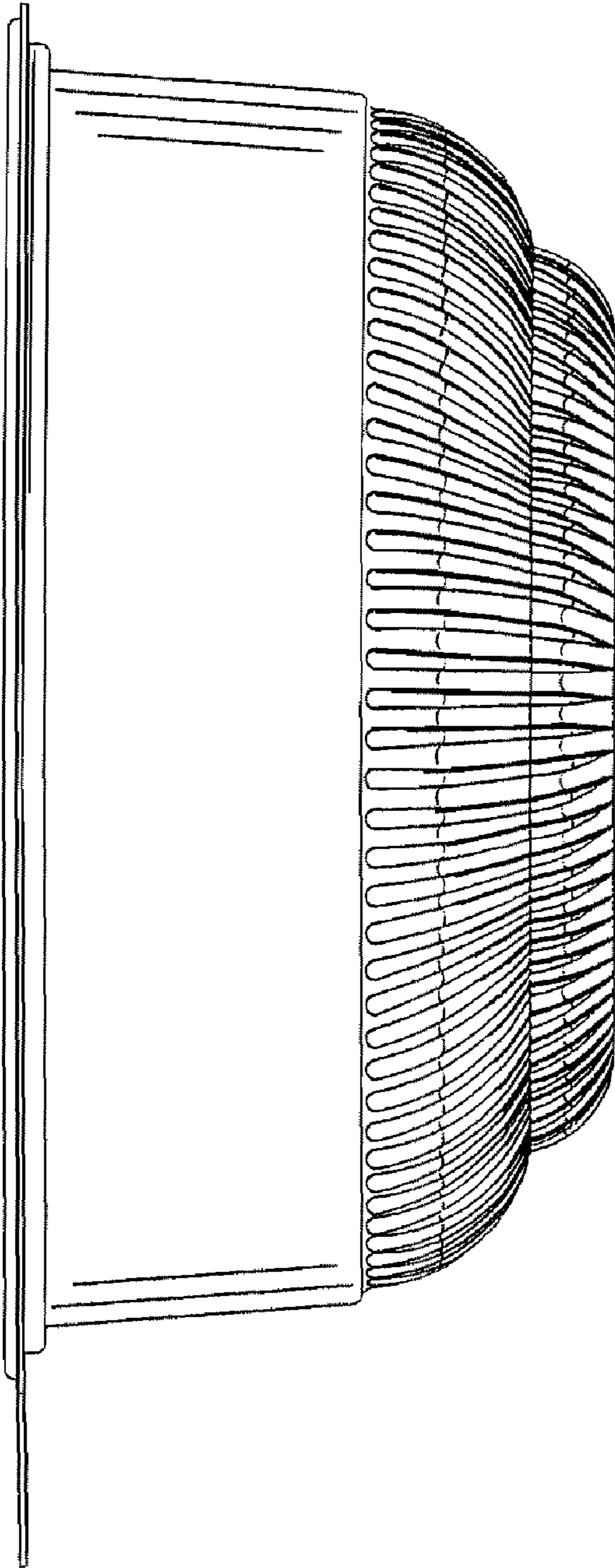

FIG. 20

UNITED STATES PATENT AND TRADEMARK OFFICE
CERTIFICATE OF CORRECTION

PATENT NO. : Des. 603,222 S
APPLICATION NO. : 29/273019
DATED : November 3, 2009
INVENTOR(S) : Kevin Krueger et al.

Page 1 of 1

It is certified that error appears in the above-identified patent and that said Letters Patent is hereby corrected as shown below:

Title page, item [57] should read as follows:

The ornamental design for a reserving microwave container comprising a ~~bowl, lid, and~~ bowl with a lid as shown ~~and described~~.

Signed and Sealed this

Twenty-ninth Day of December, 2009

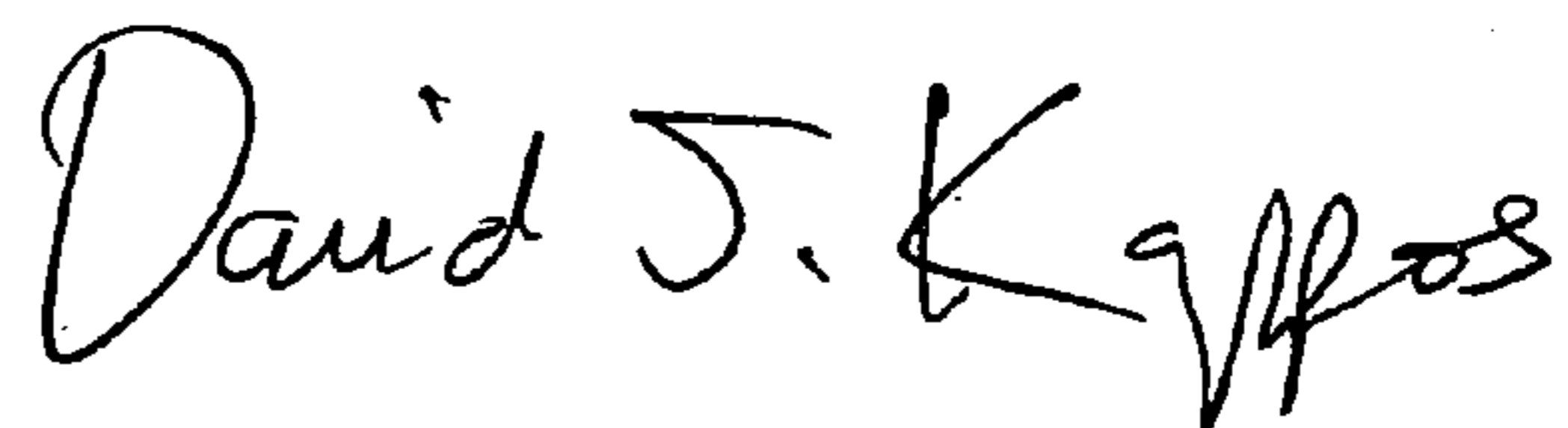

David J. Kappos
Director of the United States Patent and Trademark Office