

US00D603193S

(12) **United States Design Patent**
Sandoval

(10) **Patent No.:** **US D603,193 S**

(45) **Date of Patent:** **** Nov. 3, 2009**

(54) **BASE FOR A CHAIR**

D464,817 S * 10/2002 Lopez D6/349
D472,396 S * 4/2003 de Blois D6/349

(76) Inventor: **Tino Sandoval**, P.O. Box 3345, Clovis,
CA (US) 93613

* cited by examiner

(**) Term: **14 Years**

Primary Examiner—Sandra Snapp
(74) *Attorney, Agent, or Firm*—Richard A. Ryan

(21) Appl. No.: **29/286,783**

(57) **CLAIM**

(22) Filed: **May 17, 2007**

The ornamental design for a base for a chair, as shown and described.

(51) **LOC (9) Cl.** **06-01**

(52) **U.S. Cl.** **D6/500**

(58) **Field of Classification Search** D6/334–338,
D6/349, 355, 361, 368–370, 376, 379–381,
D6/492, 500–502; 297/16.1, 42, 94, 135,
297/175, 232, 233, 350, 351, 445.1, 448.1,
297/448.2, 451.9; 5/12.1, 12.2

See application file for complete search history.

DESCRIPTION

FIG. 1 is a perspective view showing the new design;
FIG. 2 is a front view thereof;
FIG. 3 is a back view thereof;
FIG. 4 is a right side view thereof;
FIG. 5 is a top view thereof;
FIG. 6 is a bottom view thereof; and,
FIG. 7 is a perspective view of the base for a chair of FIG. 1 showing an alternate configuration using sliding foot pads on the bottom of the legs.

(56) **References Cited**

U.S. PATENT DOCUMENTS

D345,472 S * 3/1994 Sheftel D6/429
D355,546 S * 2/1995 Hewitt D6/480
D379,950 S * 6/1997 Davis D12/130
D436,763 S * 1/2001 Balolia D6/480

1 Claim, 7 Drawing Sheets

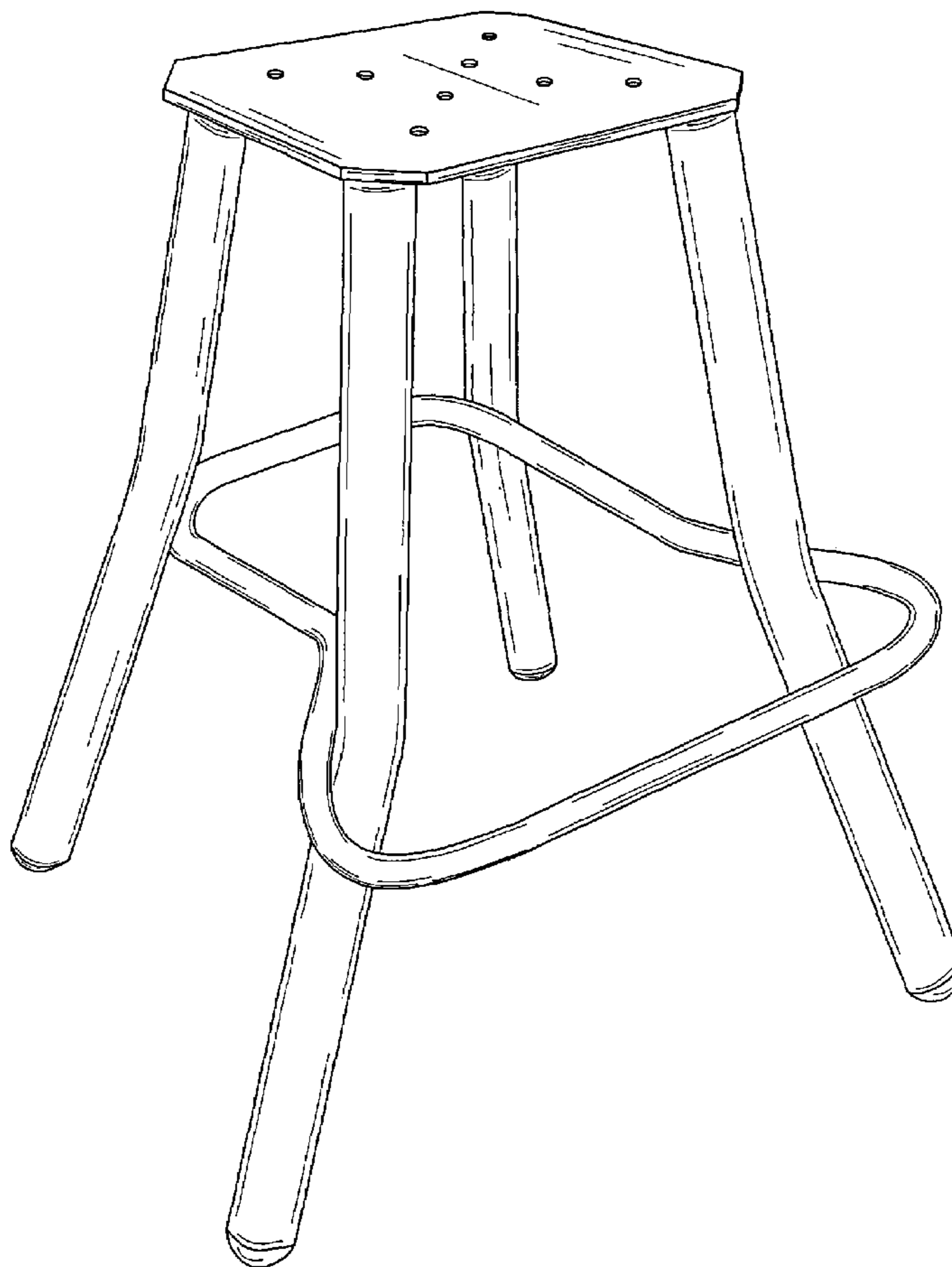

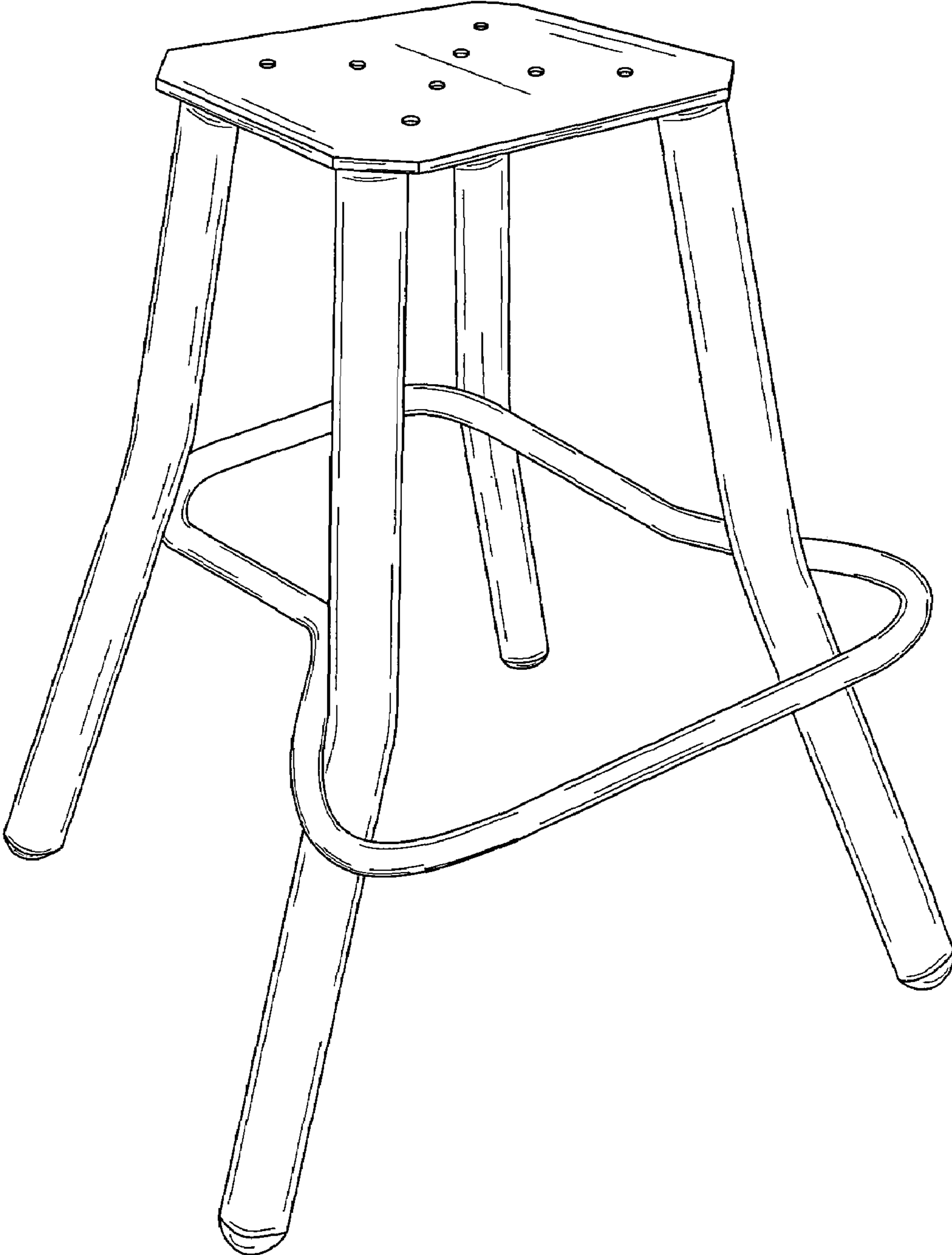

FIG. 1

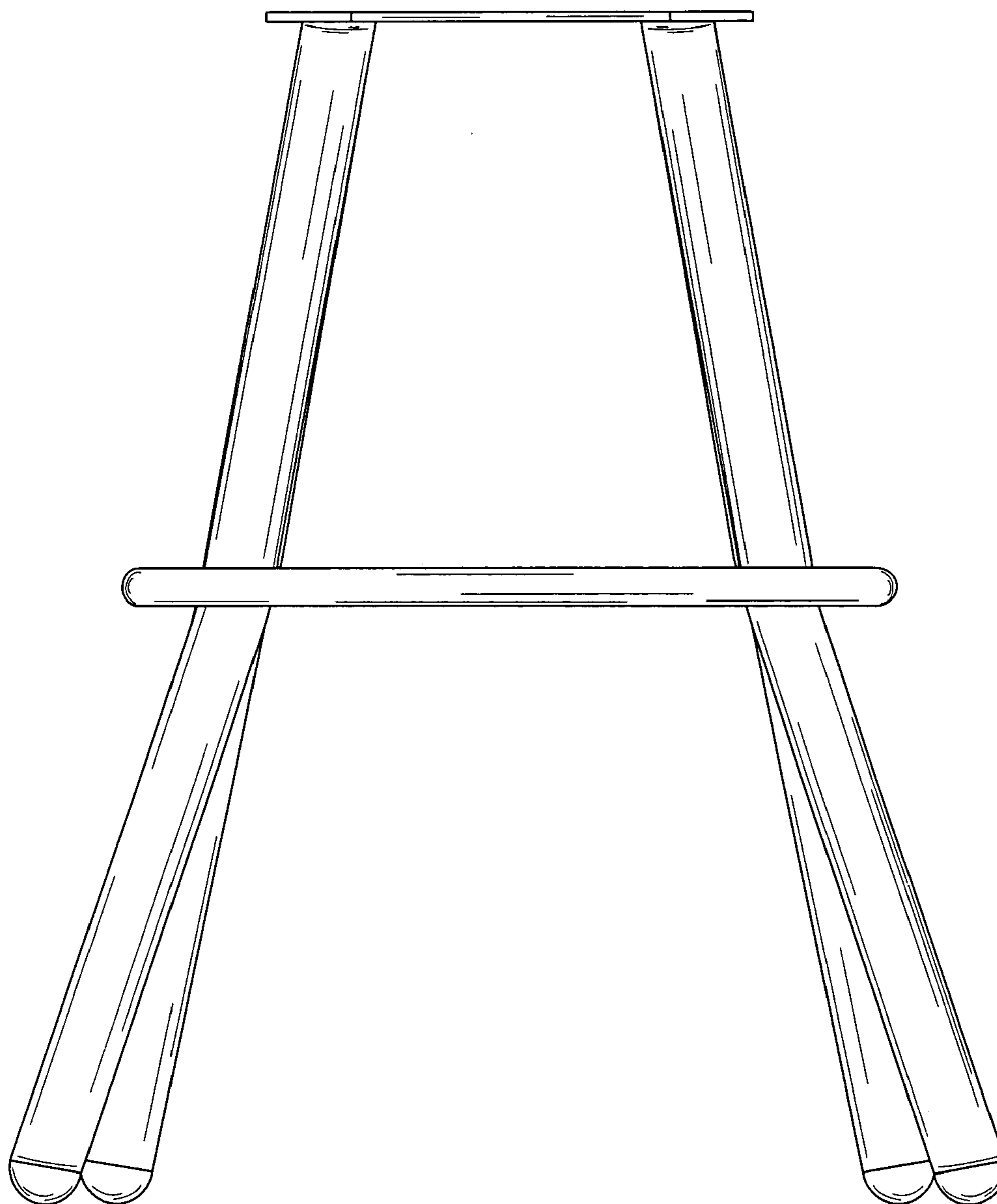

FIG. 2

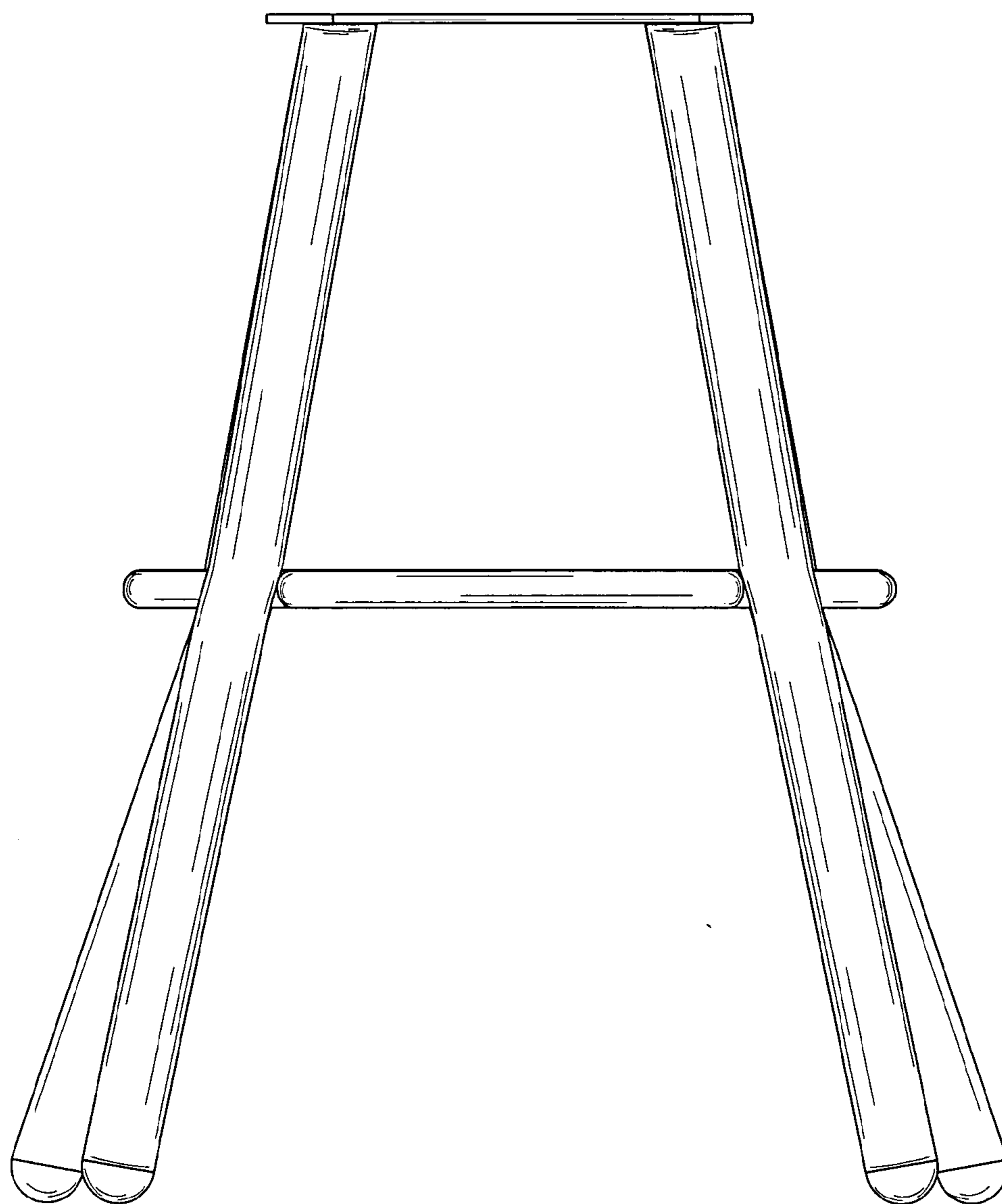

FIG. 3

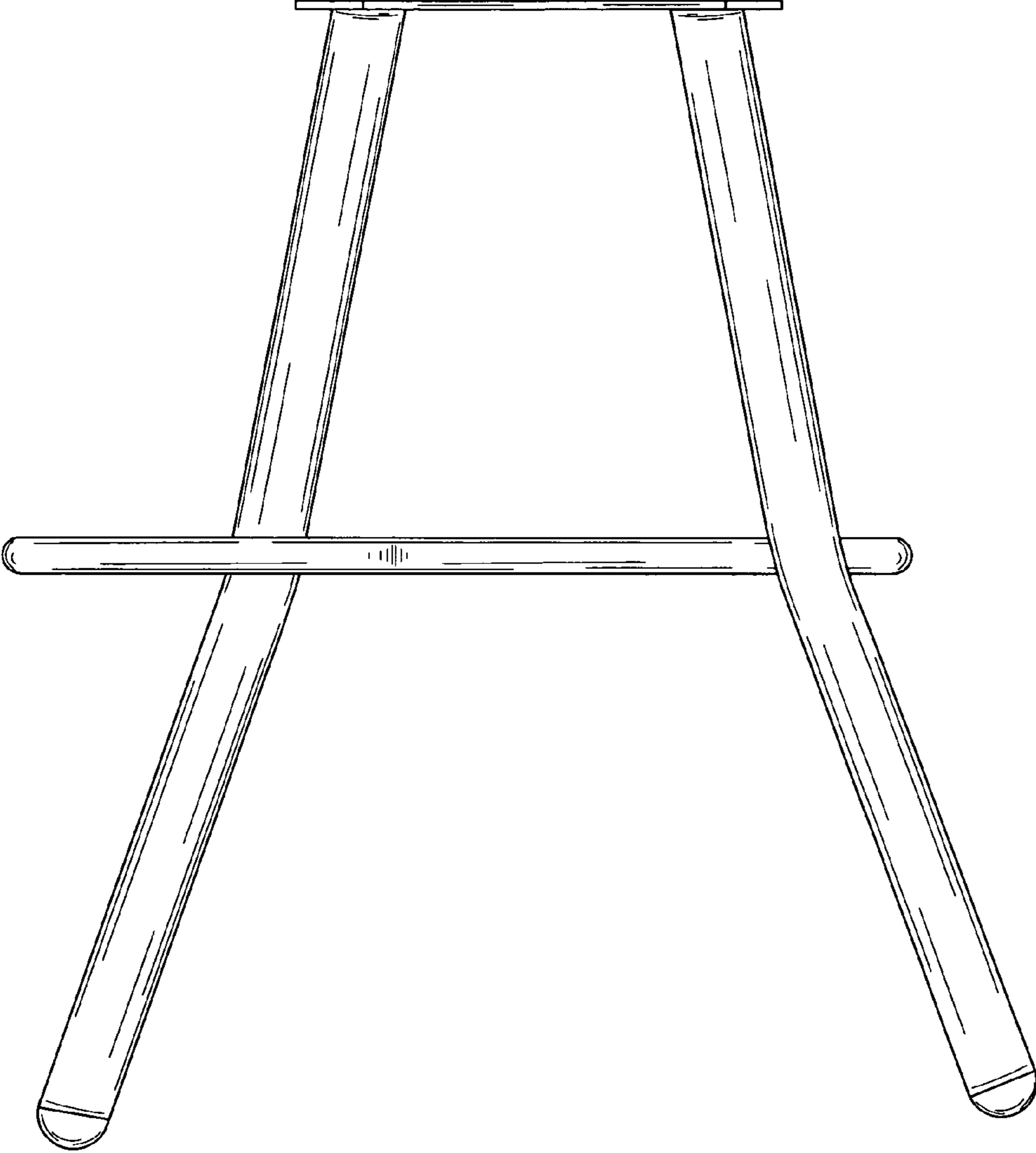

FIG. 4

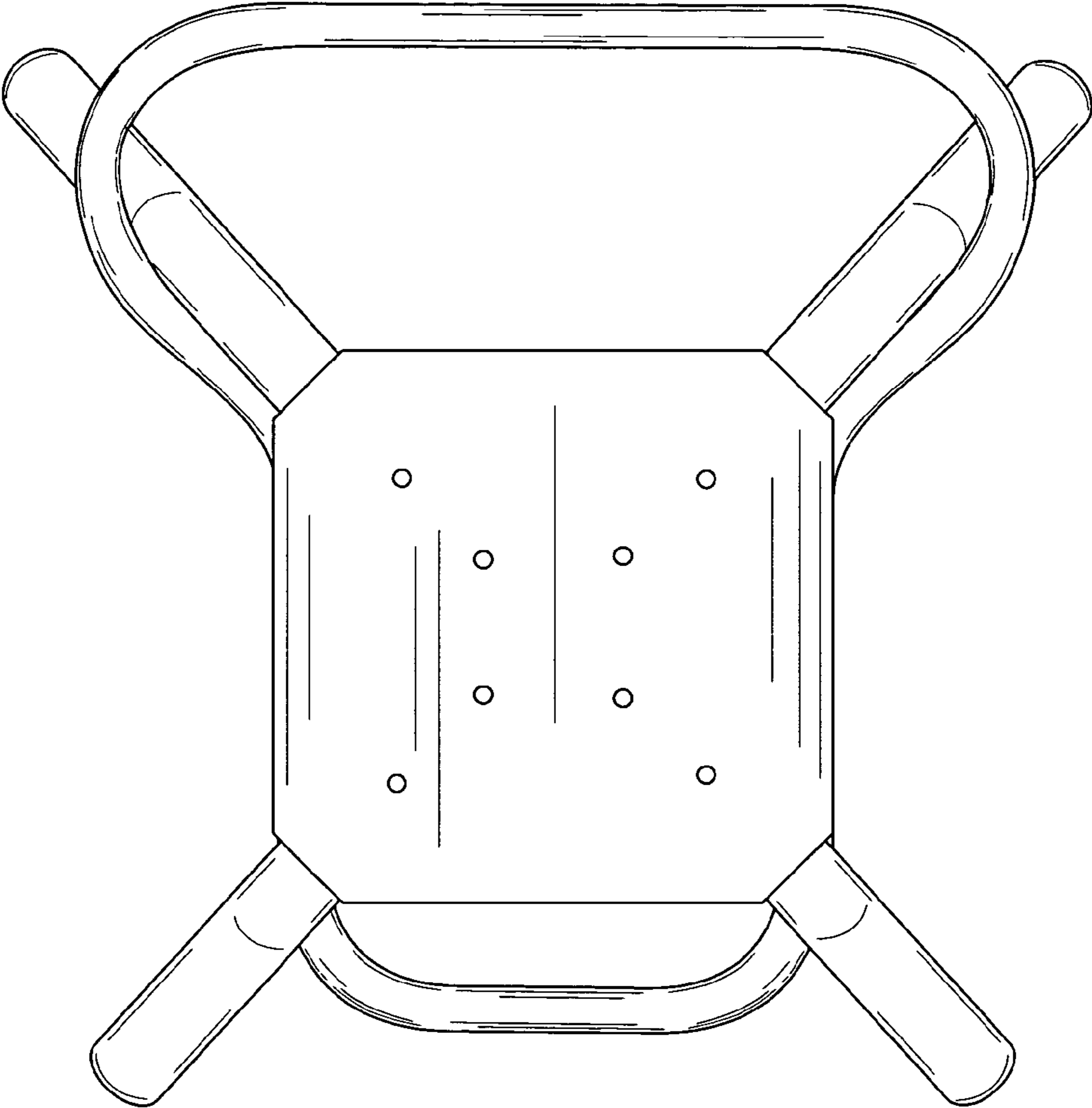

FIG. 5

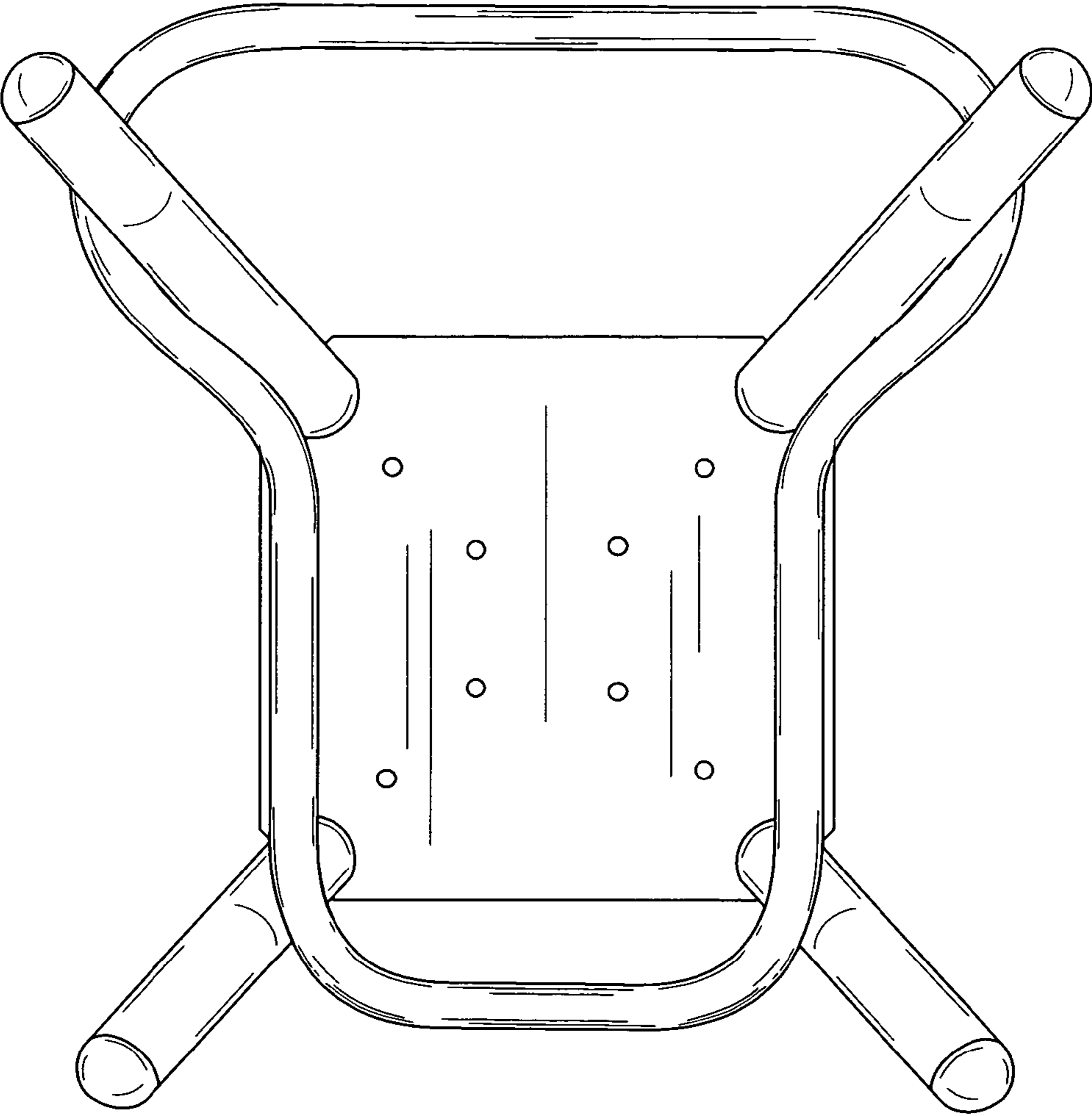

FIG. 6

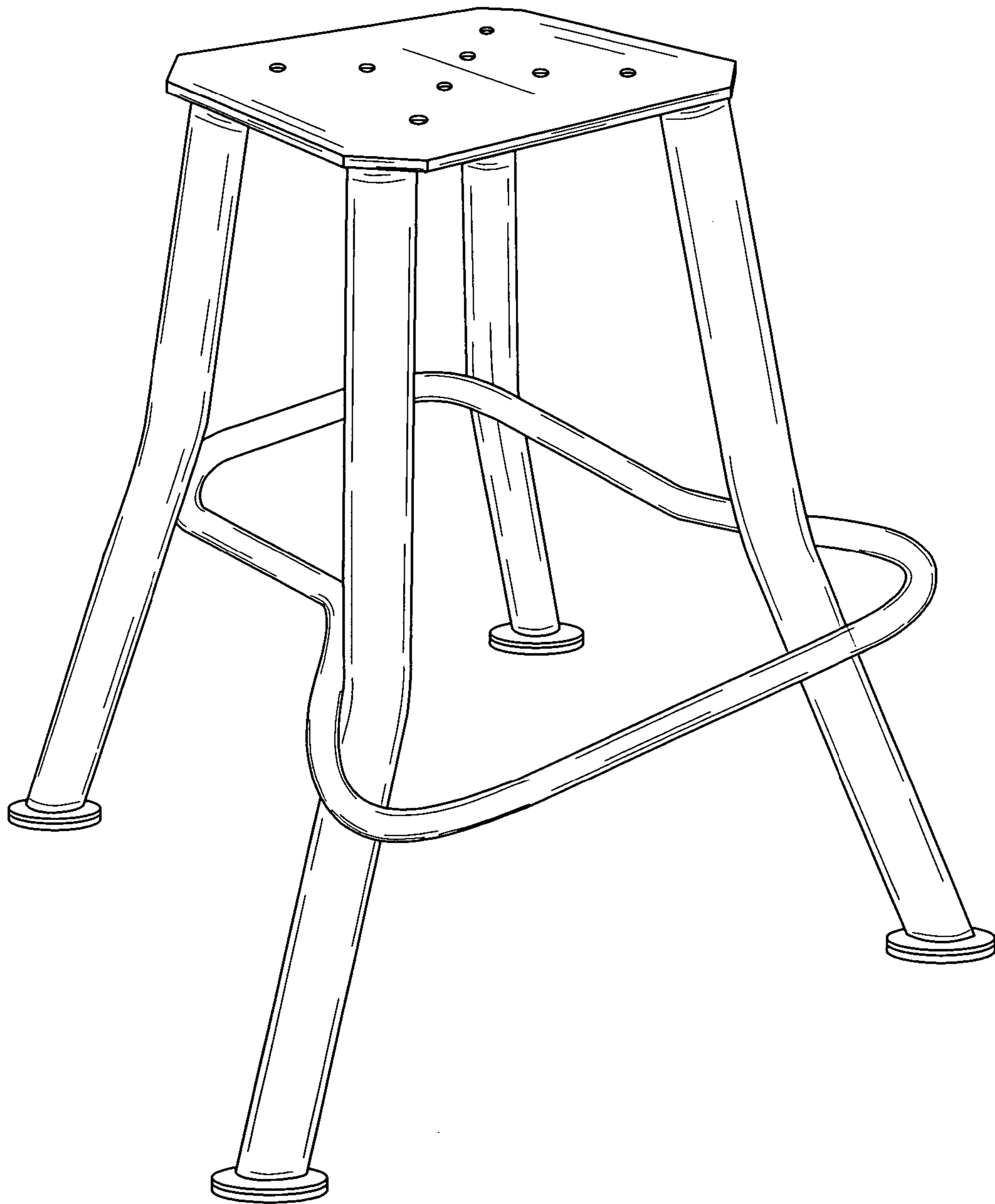

FIG. 7