



US00D603157S

(12) **United States Design Patent**  
**Hutchinson**

(10) **Patent No.:** **US D603,157 S**

(45) **Date of Patent:** **\*\* Nov. 3, 2009**

(54) **COMBINATION SECURITY PACK AND COVER**

(76) Inventor: **Danstan R. Hutchinson**, 37 Whitewood Dr., Morris Plains, NJ (US) 07950-3333

(\*\*) Term: **14 Years**

(21) Appl. No.: **29/270,519**

(22) Filed: **Dec. 27, 2006**

(51) **LOC (9) Cl.** ..... **03-01**

(52) **U.S. Cl.** ..... **D3/217**

(58) **Field of Classification Search** ..... D3/216,  
D3/217, 254, 273, 221, 318, 319, 327, 321,  
D3/907; 224/153, 254, 259; 150/105; 190/18 A,  
190/18 R, 100, 102

See application file for complete search history.

(56) **References Cited**

**U.S. PATENT DOCUMENTS**

3,923,222	A *	12/1975	Groves	.....	294/157
5,170,907	A *	12/1992	Sakai	.....	220/481
D335,030	S *	4/1993	Alfonso	.....	D3/279
6,279,796	B1 *	8/2001	Trevino	.....	224/153
D513,879	S *	1/2006	Waples	.....	D3/321
D523,243	S *	6/2006	Nashmy	.....	D3/285
D531,807	S *	11/2006	Koenig et al.	.....	D3/327
D535,099	S *	1/2007	Johansson et al.	.....	D3/276
D554,369	S *	11/2007	Katz et al.	.....	D3/279
D554,862	S *	11/2007	Hsieh	.....	D3/279
D557,899	S *	12/2007	Chang	.....	D3/318

\* cited by examiner

*Primary Examiner*—Ian Simmons

*Assistant Examiner*—Anna J Burmeister

(74) *Attorney, Agent, or Firm*—Paul R. Gauer

(57) **CLAIM**

The ornamental design for a combination security pack and cover, as shown and described.

**DESCRIPTION**

FIG. 1 is a front perspective view of a combination security pack and cover, shown in the combined condition, showing my new design;

FIG. 2 is a front elevational view thereof;

FIG. 3 is a rear elevational view thereof;

FIG. 4 is a right side elevational view thereof;

FIG. 5 is a left side elevational view thereof;

FIG. 6 is a top plan view thereof;

FIG. 7 is a bottom plan view thereof;

FIG. 8 is a front perspective view thereof, shown in the separated condition,

FIG. 9 is a front elevational view thereof;

FIG. 10 is a rear elevational view thereof;

FIG. 11 is a right side elevational view thereof;

FIG. 12 is a left side elevational view thereof;

FIG. 13 is a top plan view thereof; and,

FIG. 14 is a bottom plan view thereof.

The broken lines showing the slide fastening device and the pull tab in the drawing views are for illustrative purposes only and form no part of the claimed design.

**1 Claim, 11 Drawing Sheets**

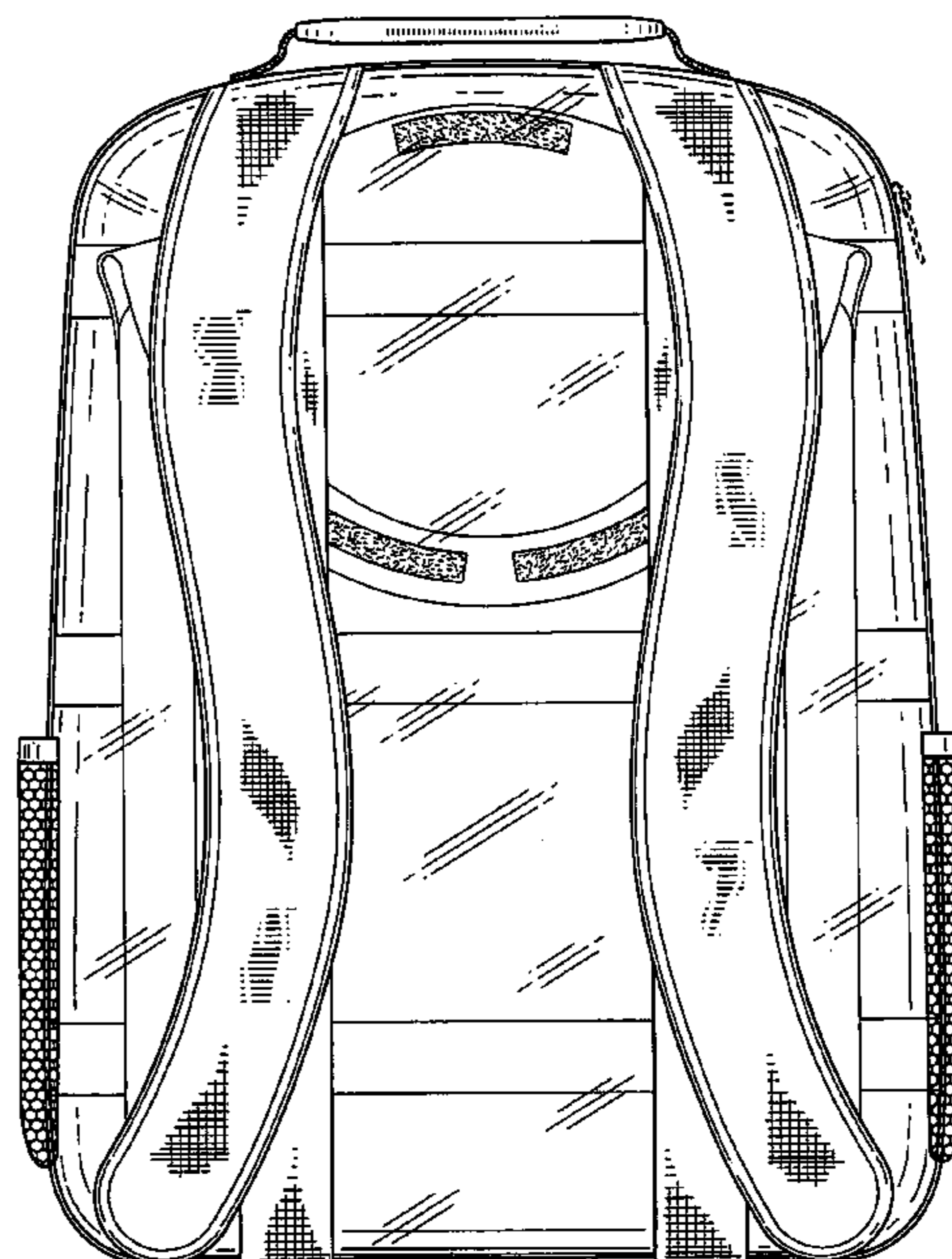
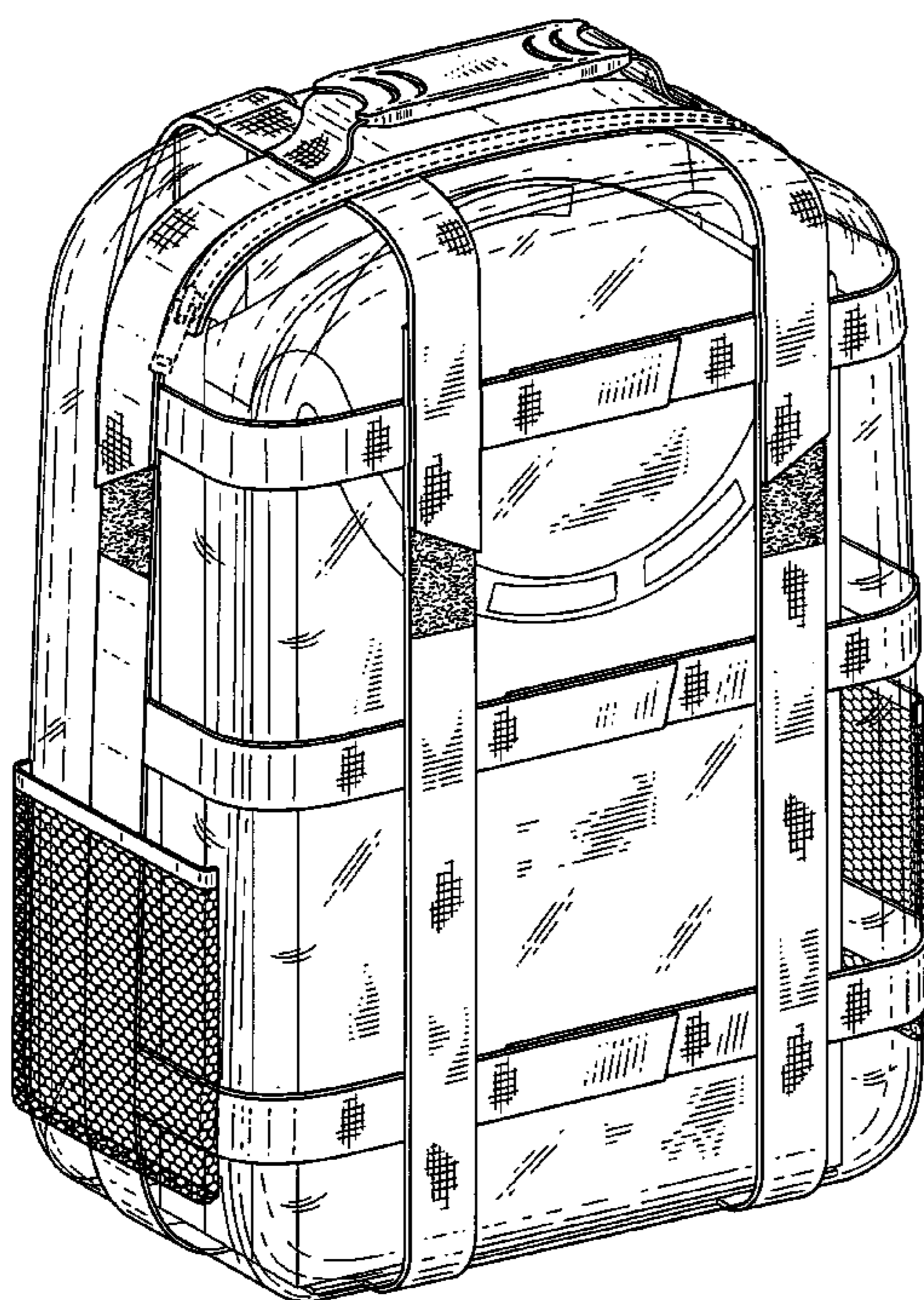



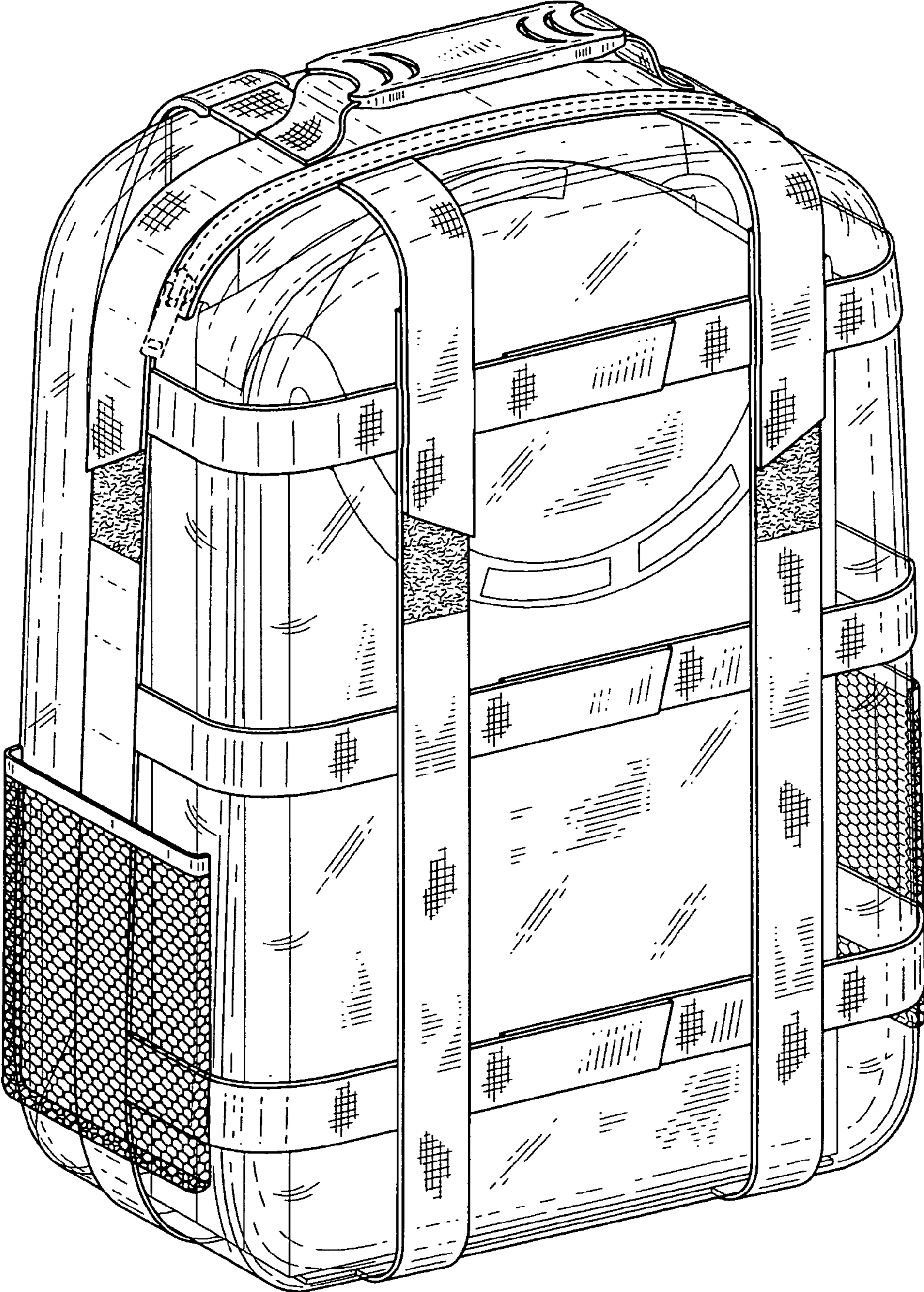

FIG. 1

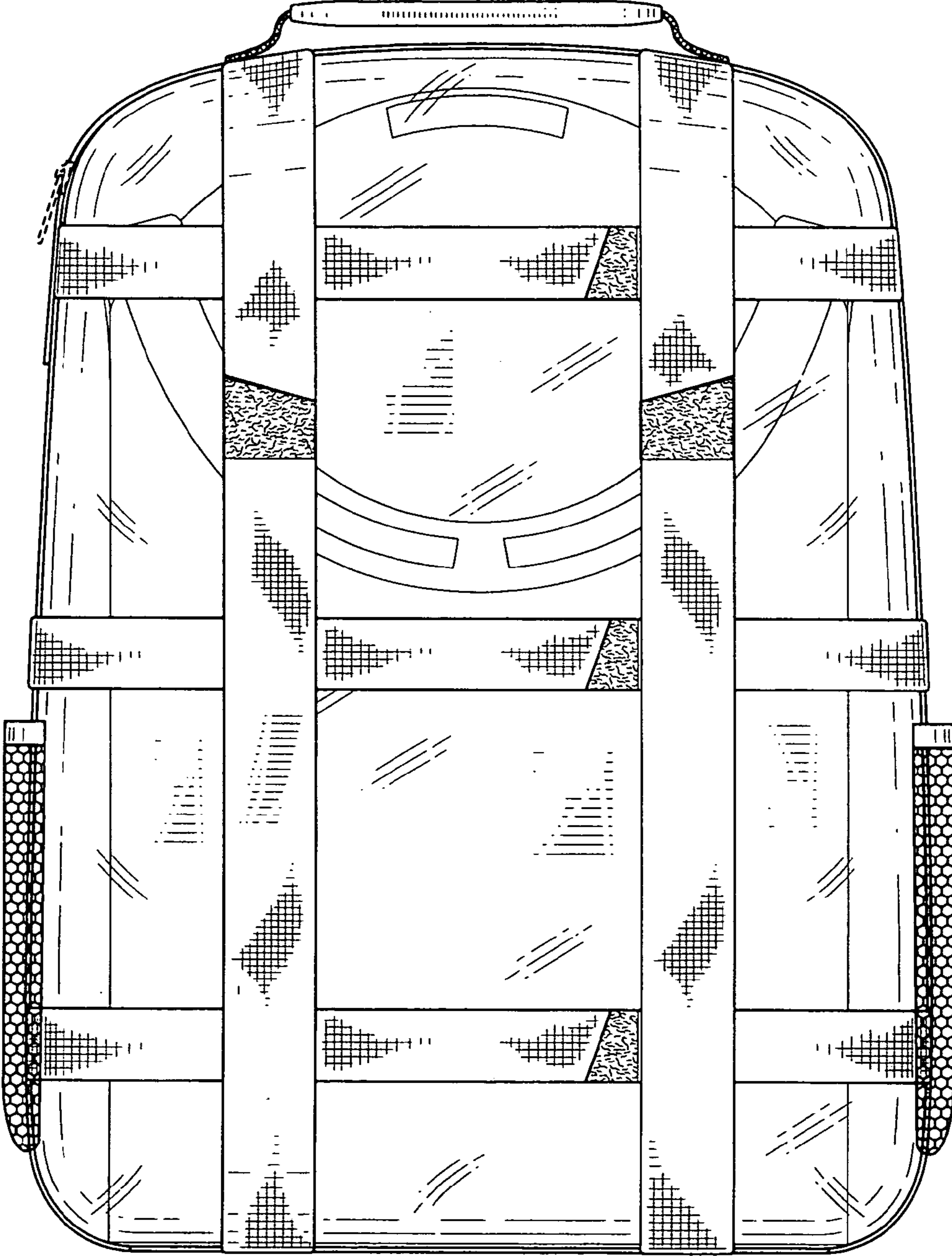

FIG. 2

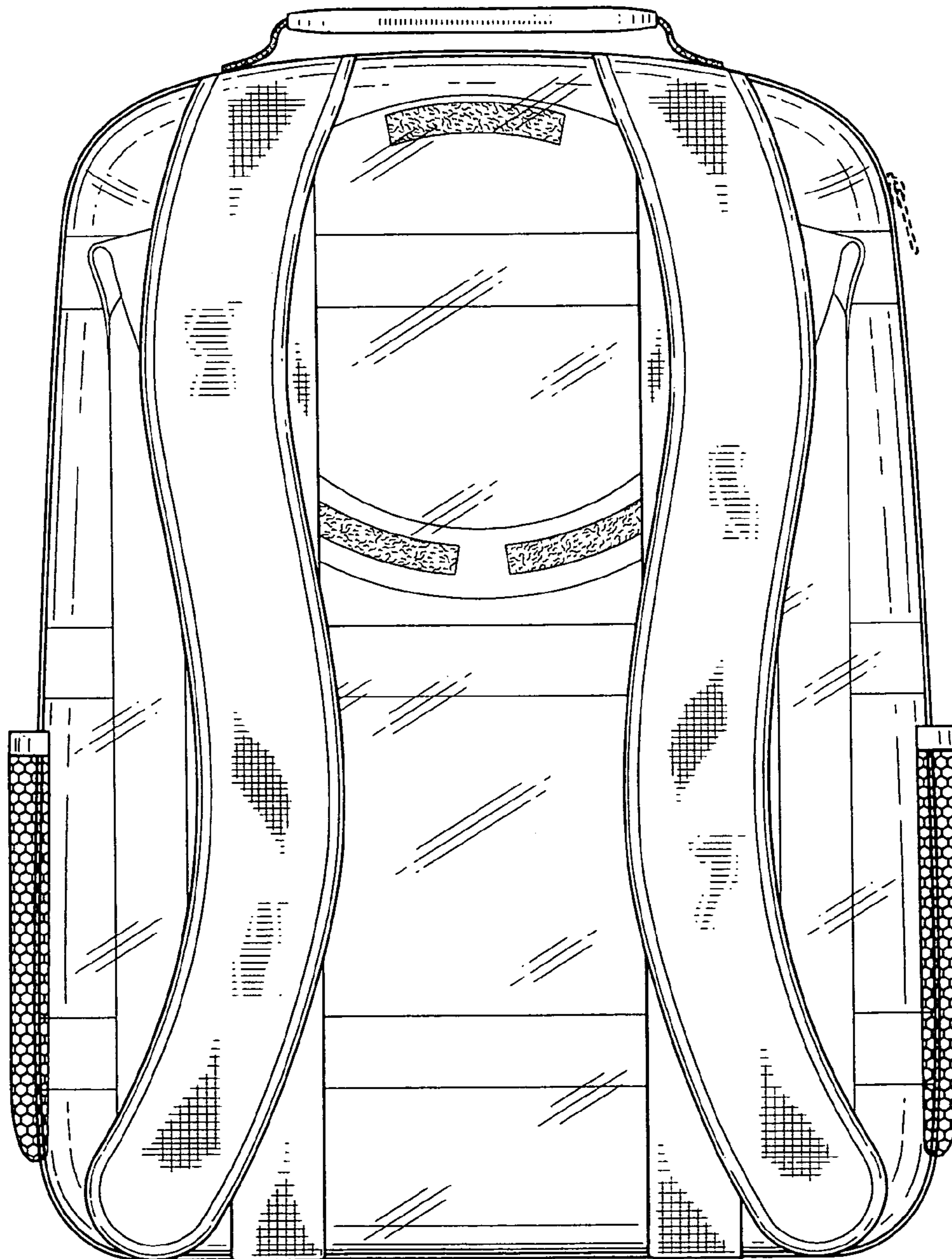

FIG. 3



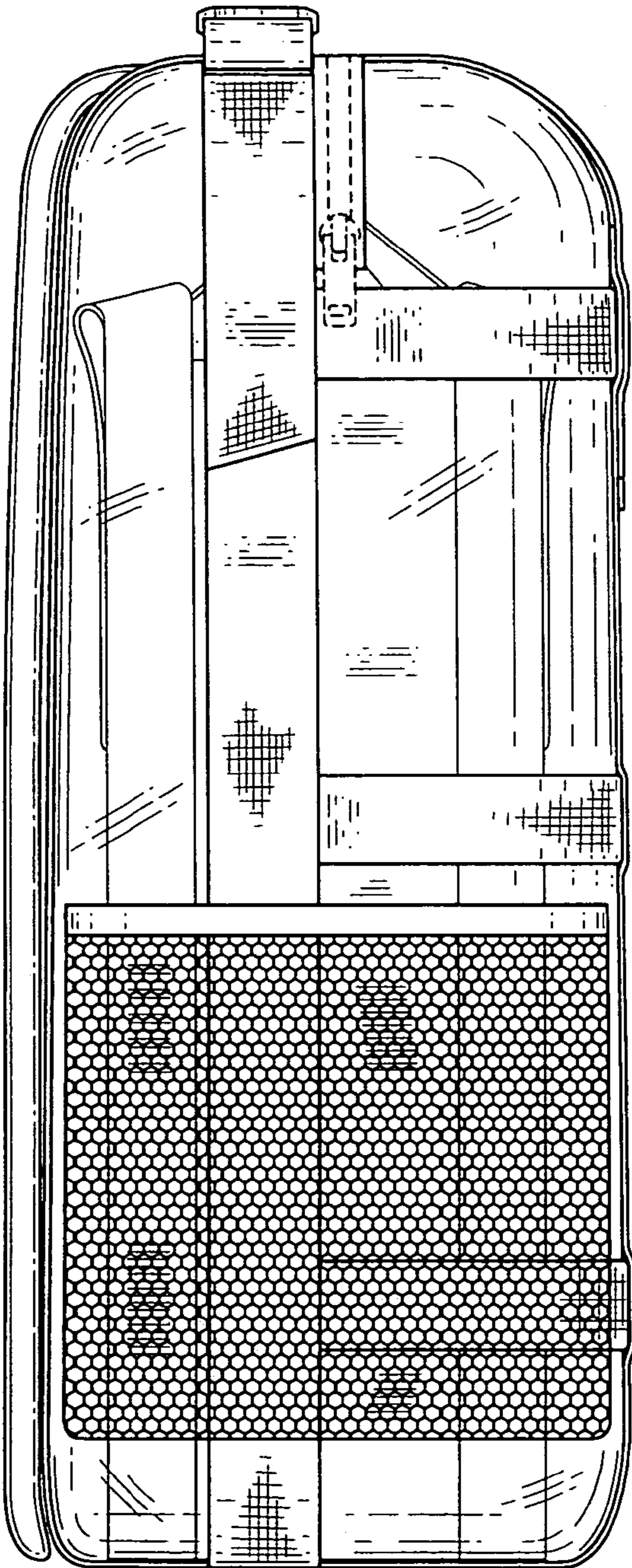

FIG. 4

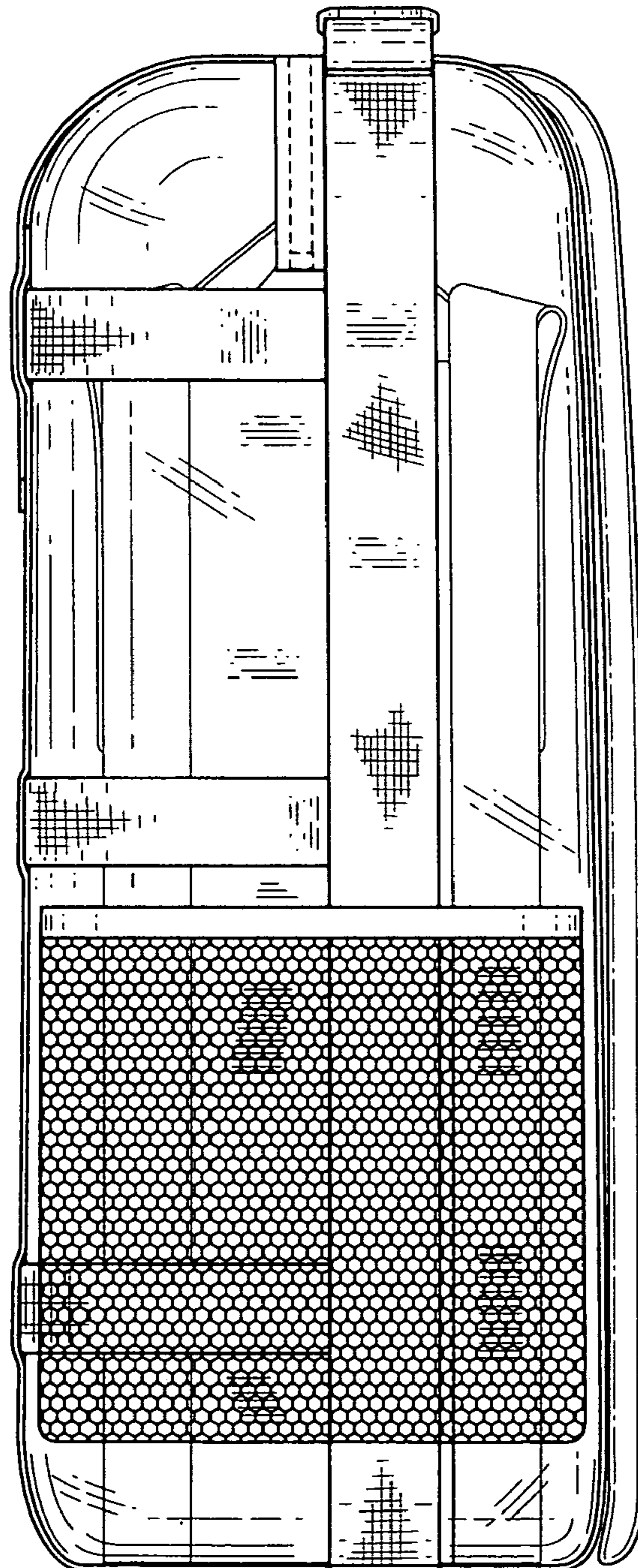

FIG. 5

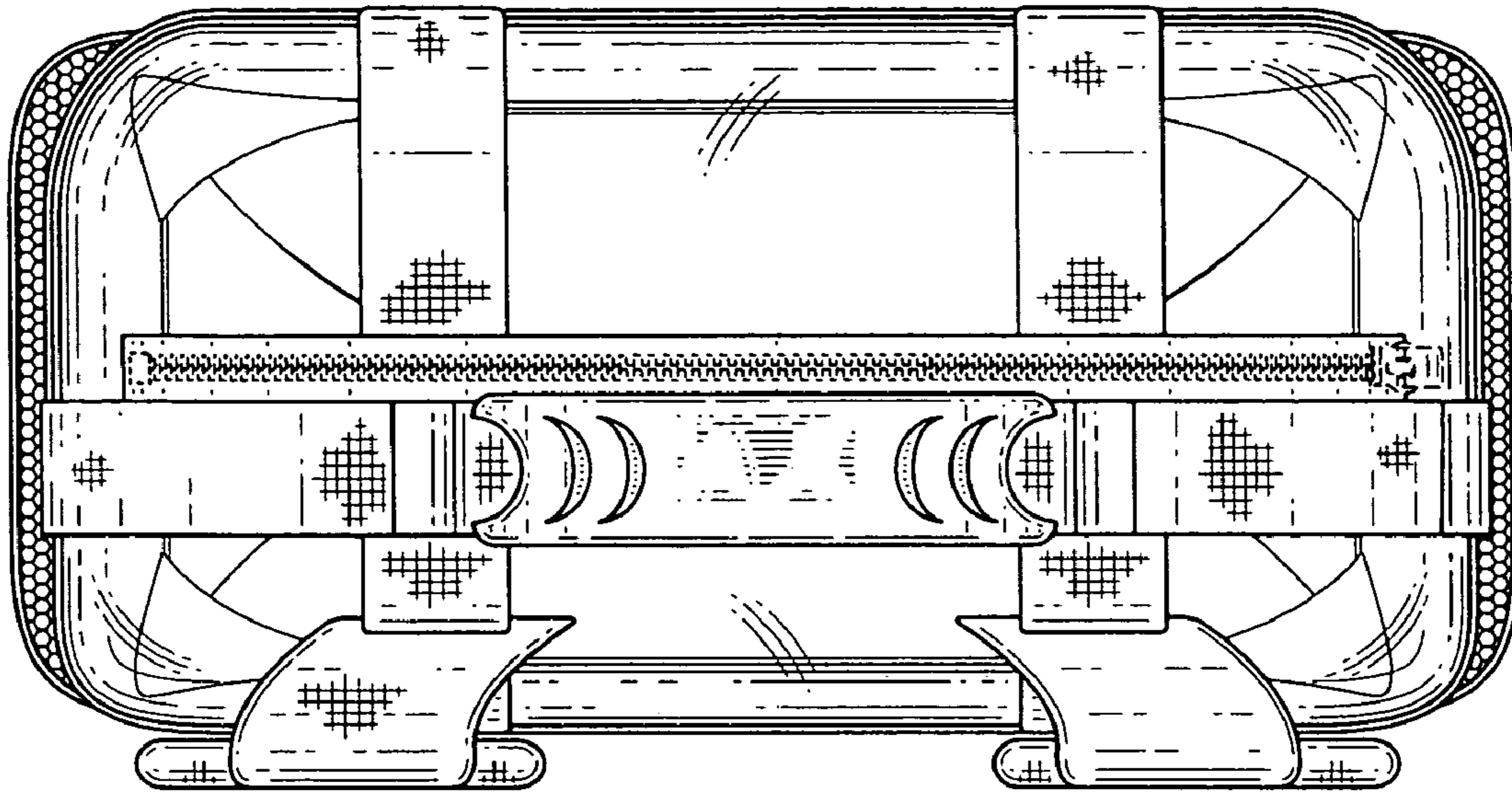

FIG. 6

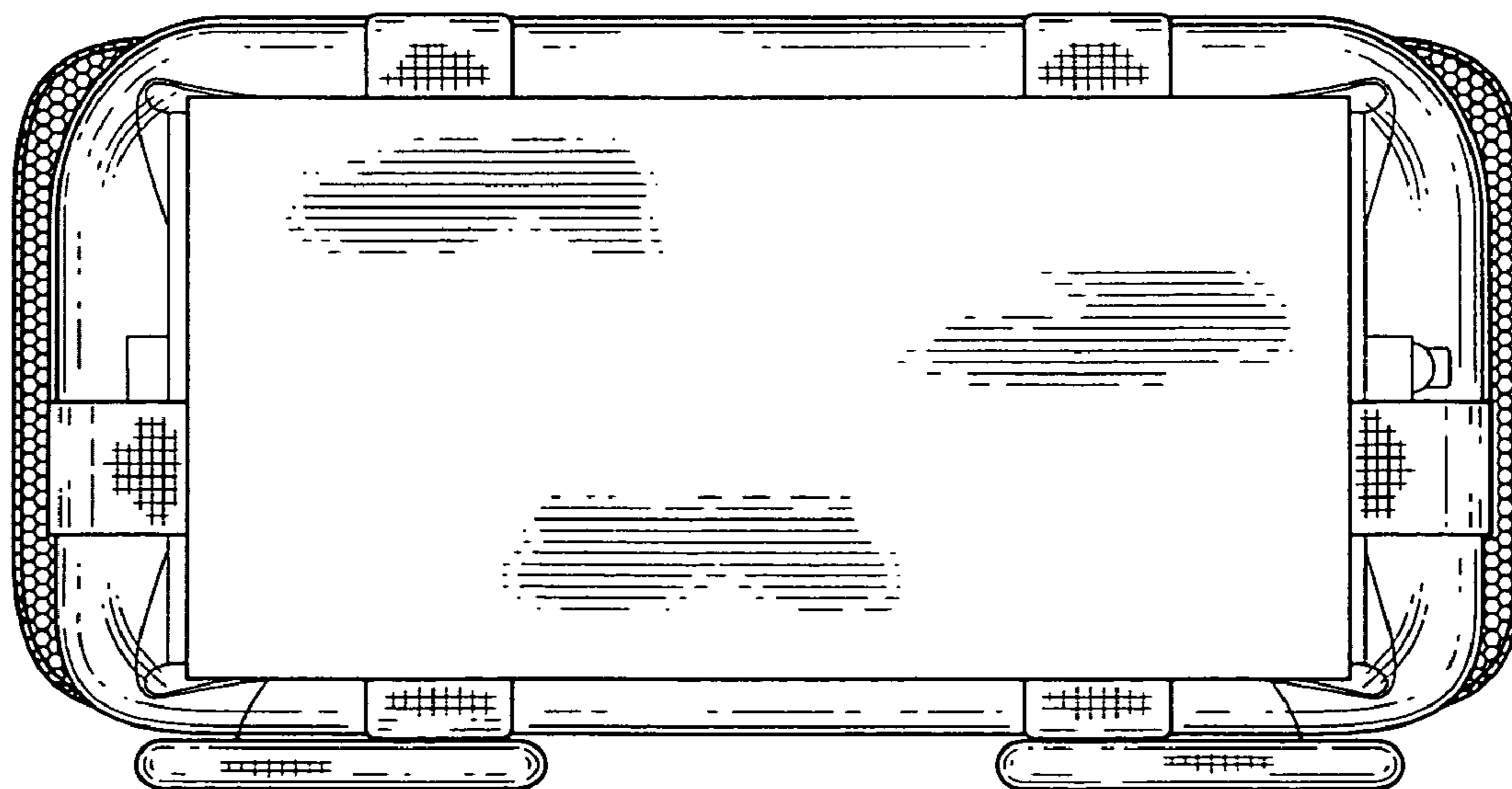

FIG. 7



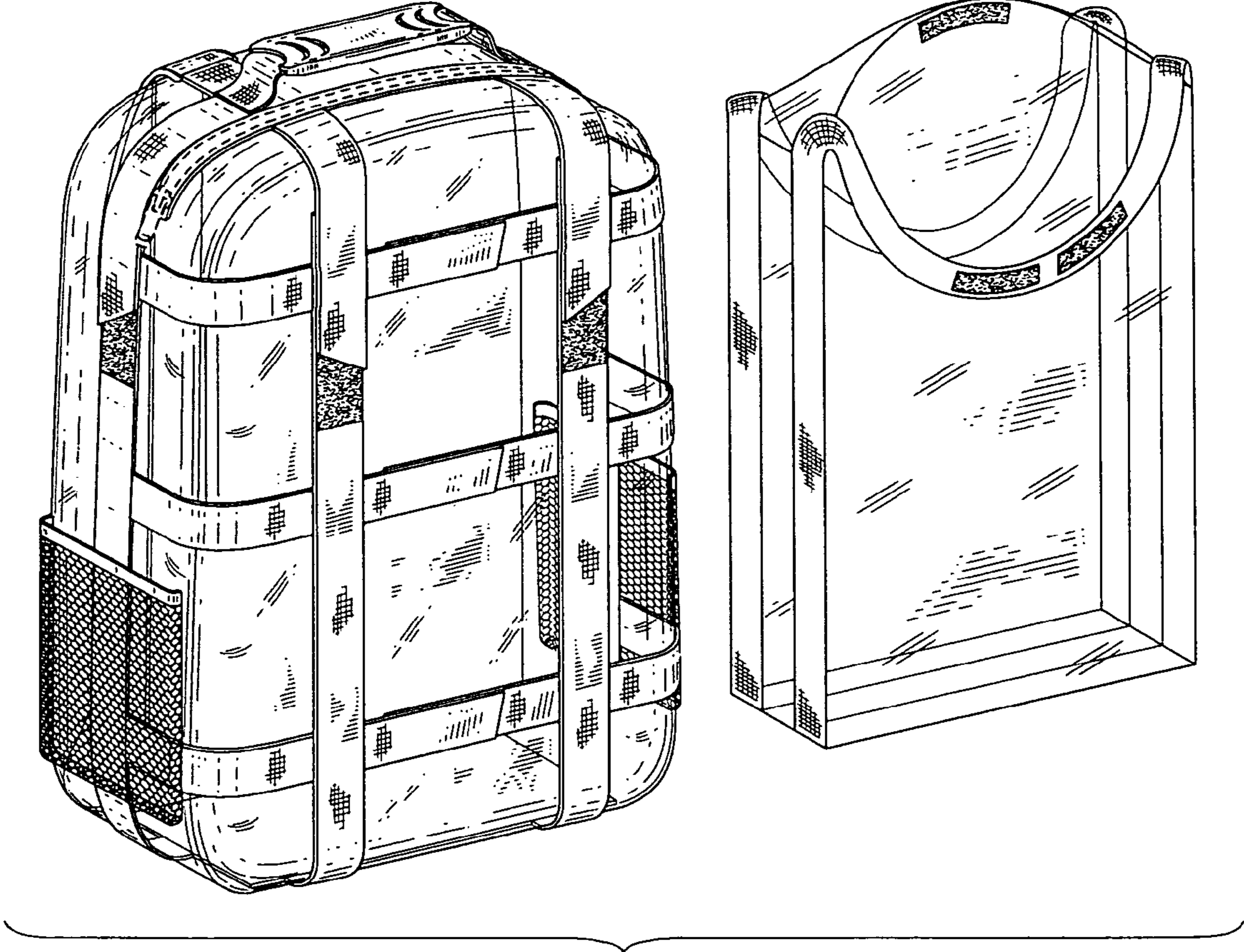

FIG. 8



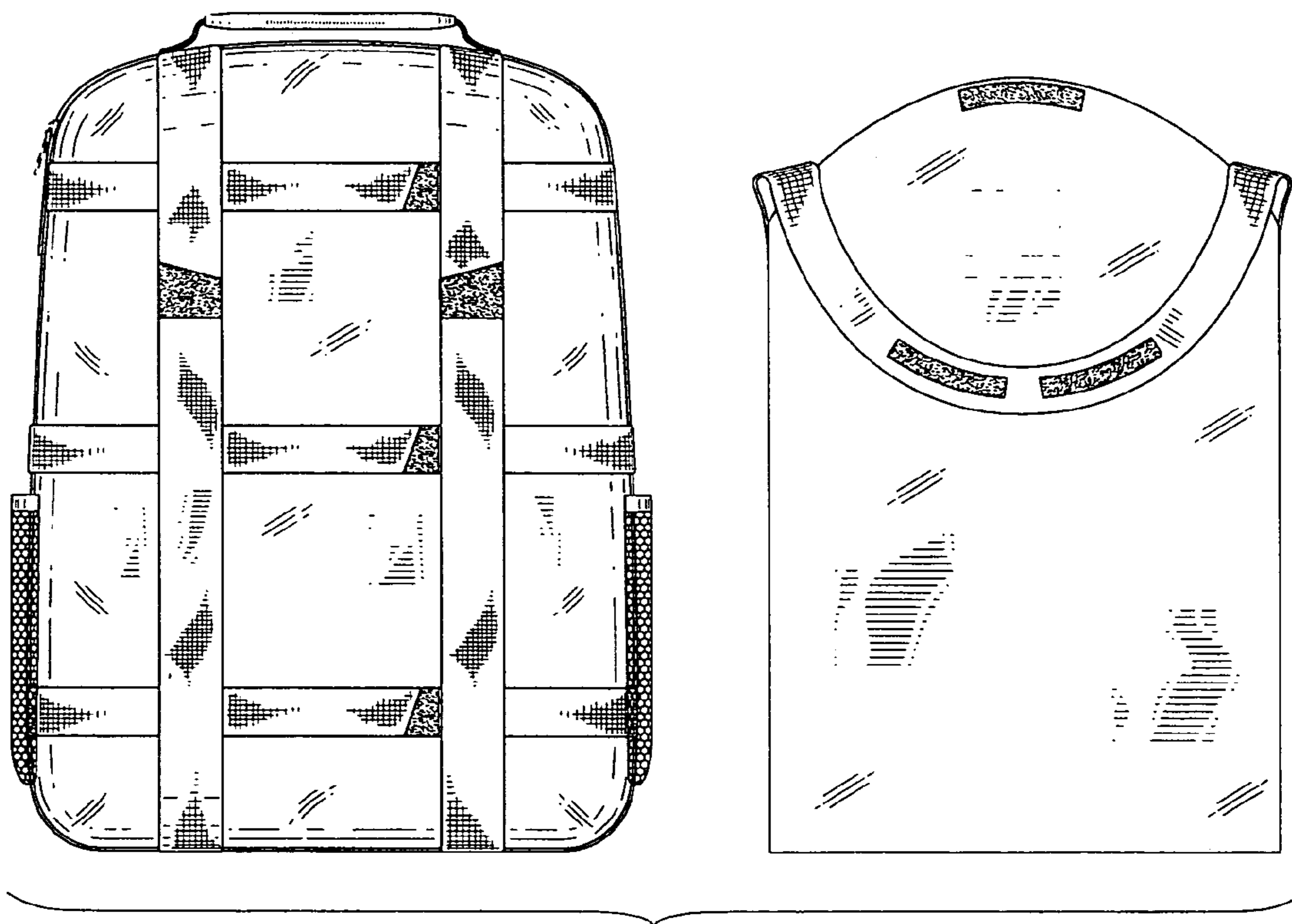

FIG. 9

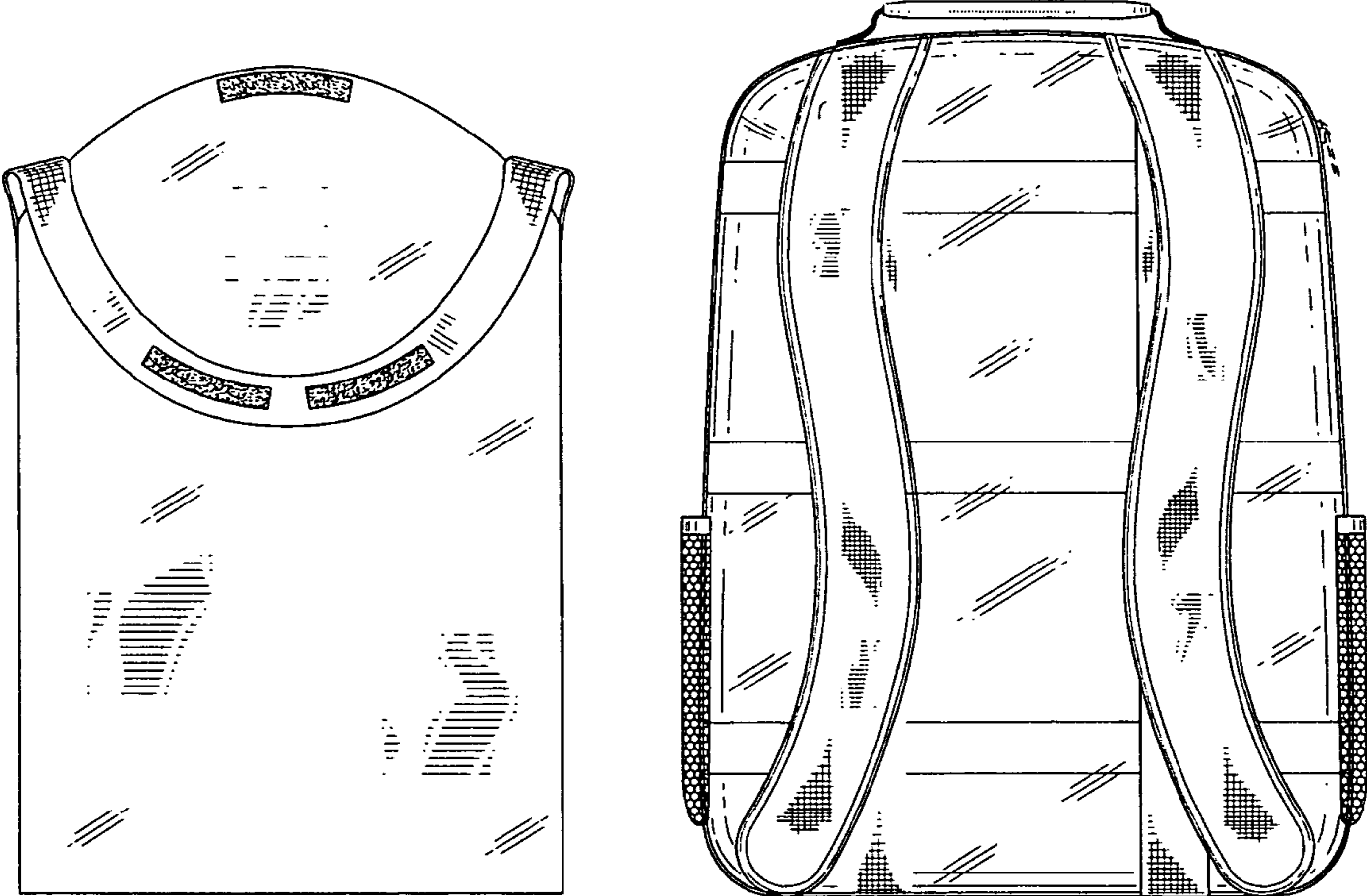

FIG. 10

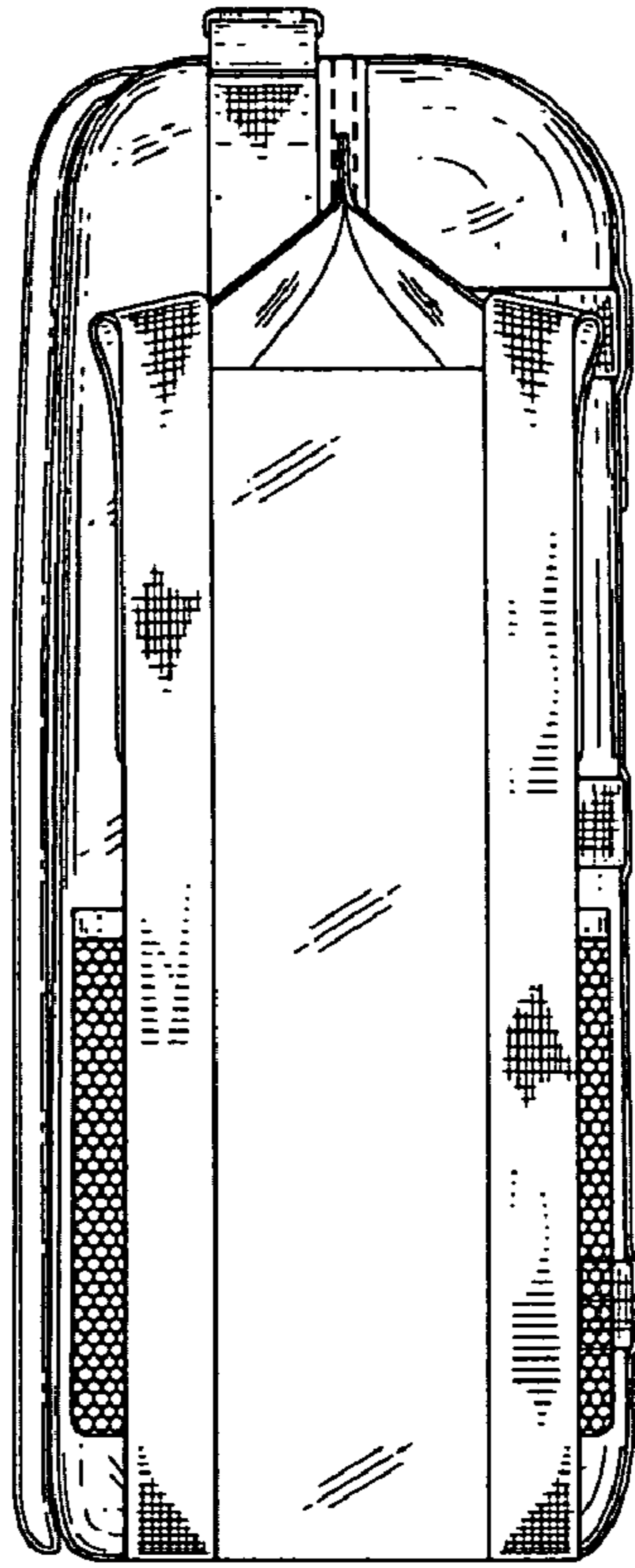

FIG. 11

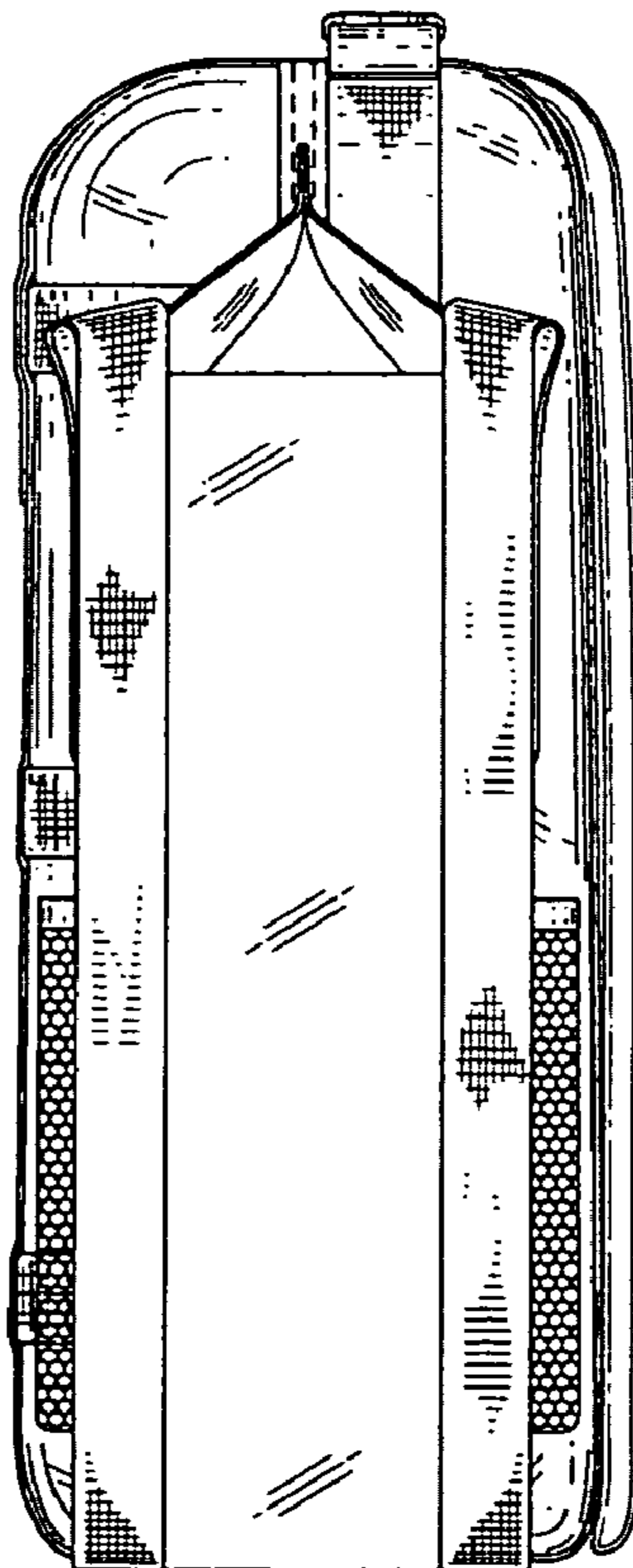

FIG. 12



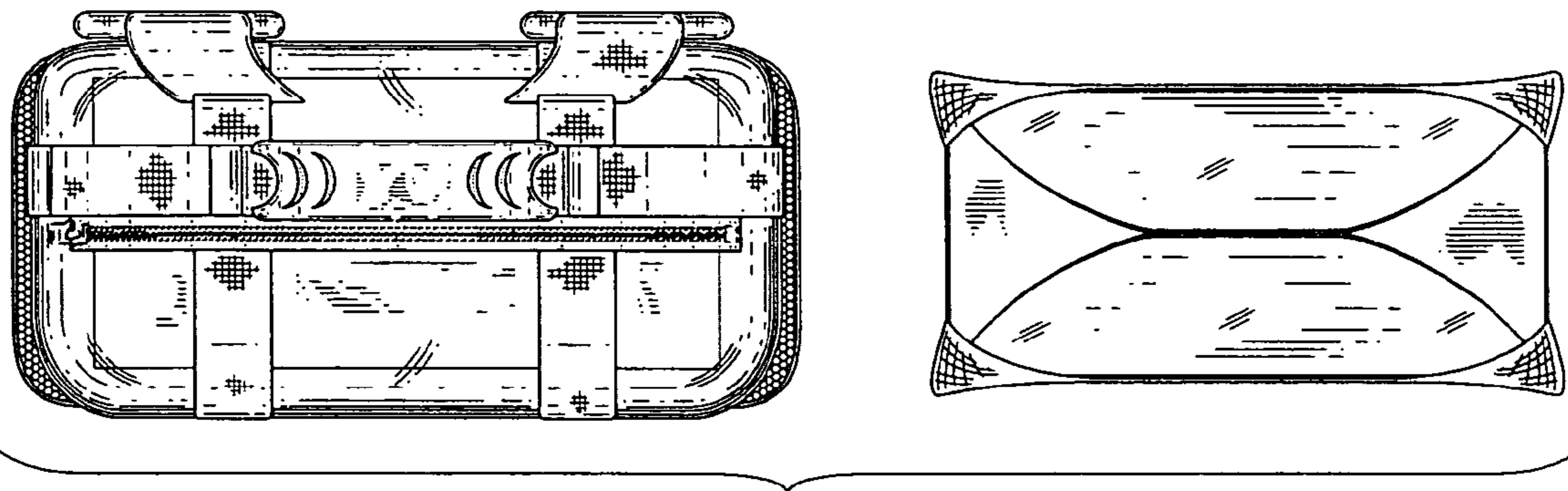

FIG. 13

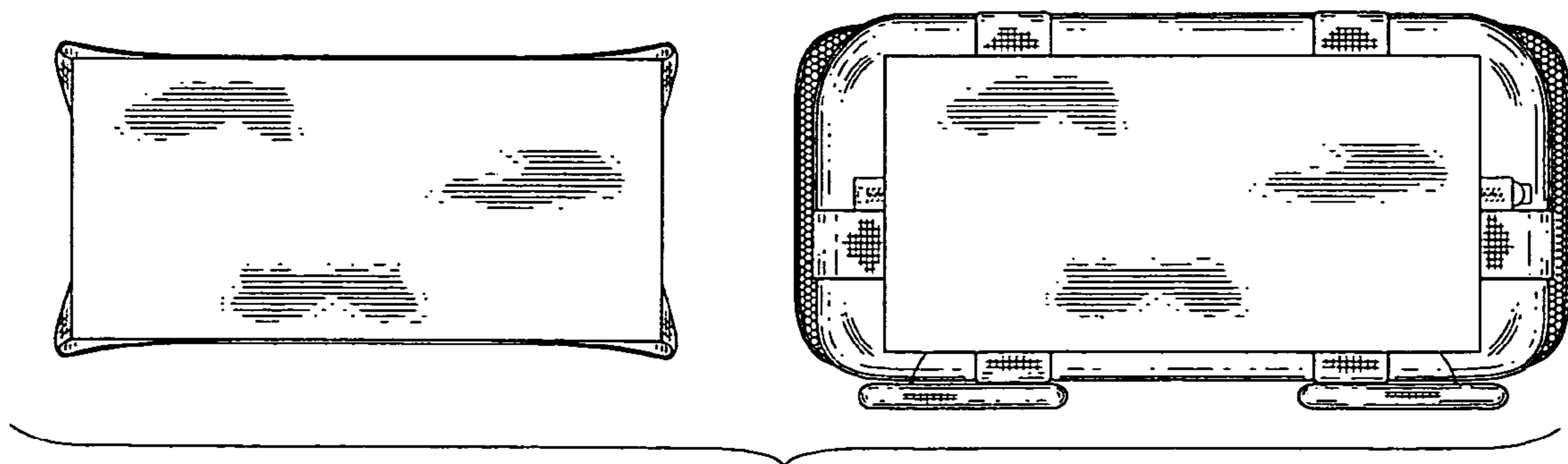

FIG. 14