



US00D603113S

(12) **United States Design Patent**
Morton

(10) **Patent No.:** **US D603,113 S**

(45) **Date of Patent:** **** Oct. 27, 2009**

(54) **SCOOP**

(75) **Inventor:** **Julian Morton**, 1097 Oakdale Rd., NE.,
Atlanta, GA (US) 30033

(73) **Assignee:** **Julian Morton**, Atlanta, GA (US)

(**) **Term:** **14 Years**

(21) **Appl. No.:** **29/326,894**

(22) **Filed:** **Oct. 27, 2008**

(51) **LOC (9) Cl.** **30-99**

(52) **U.S. Cl.** **D30/162; D7/669; D7/691**

(58) **Field of Classification Search** **D30/162;**
D7/667, 669-670, 681, 691; D8/10; 294/1.3,
294/1.4, 1.5, 9, 28, 49, 50.8, 54.5, 55
See application file for complete search history.

(56) **References Cited**

U.S. PATENT DOCUMENTS

1,540,284	A	*	6/1925	Reveny	294/49
D139,887	S	*	1/1945	Miller	D7/691
D153,783	S	*	5/1949	George	D7/691
2,539,181	A	*	1/1951	Brown	294/49
3,936,087	A	*	2/1976	Alexander	294/1.3
D257,406	S	*	10/1980	Ouellette	D30/162
D303,484	S	*	9/1989	Stanart	D8/10
D321,631	S	*	11/1991	Shaw	D8/10

D326,212	S	*	5/1992	Mingrino	D8/10
D337,244	S	*	7/1993	Kilham	D7/691
D362,161	S	*	9/1995	Rosenkranz	D7/691
D364,028	S	*	11/1995	Rouleau	D8/10
D417,042	S	*	11/1999	Hodges et al.	D30/162
D477,193	S	*	7/2003	Atnip et al.	D8/10
D525,398	S	*	7/2006	Borngesser	D30/162
D533,689	S	*	12/2006	Borngesser	D30/162

* cited by examiner

Primary Examiner—Cathy Anne MacCormac

(74) *Attorney, Agent, or Firm*—Laurence P. Colton; Smith,
Gambrell & Russell

(57) **CLAIM**

The ornamental design for a scoop, as shown and described.

DESCRIPTION

FIG. 1 is a perspective view of the scoop of the present design.
FIG. 2 is a right side view of the scoop of the present design.
FIG. 3 is a left side view of the scoop of the present design.
FIG. 4 is a top view of the scoop of the present design.
FIG. 5 is a bottom view of the scoop of the present design.
FIG. 6 is a front view of the scoop of the present design; and,
FIG. 7 is a rear view of the scoop of the present design.

1 Claim, 3 Drawing Sheets

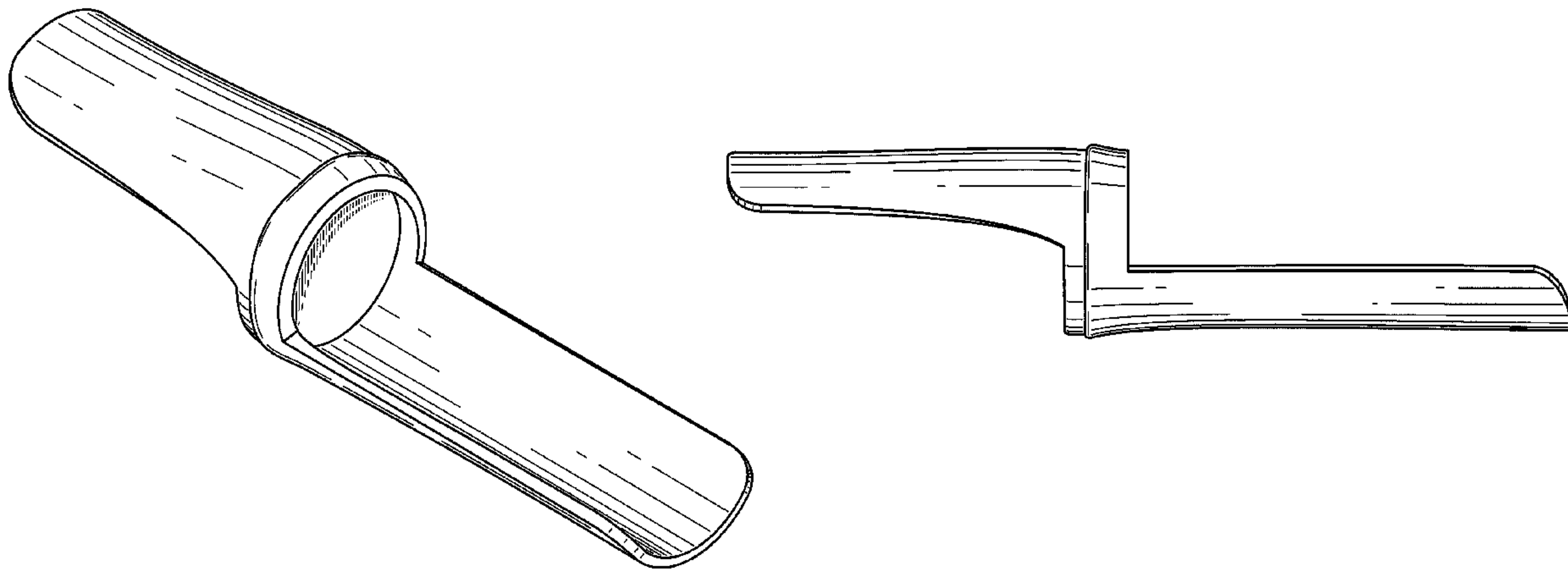

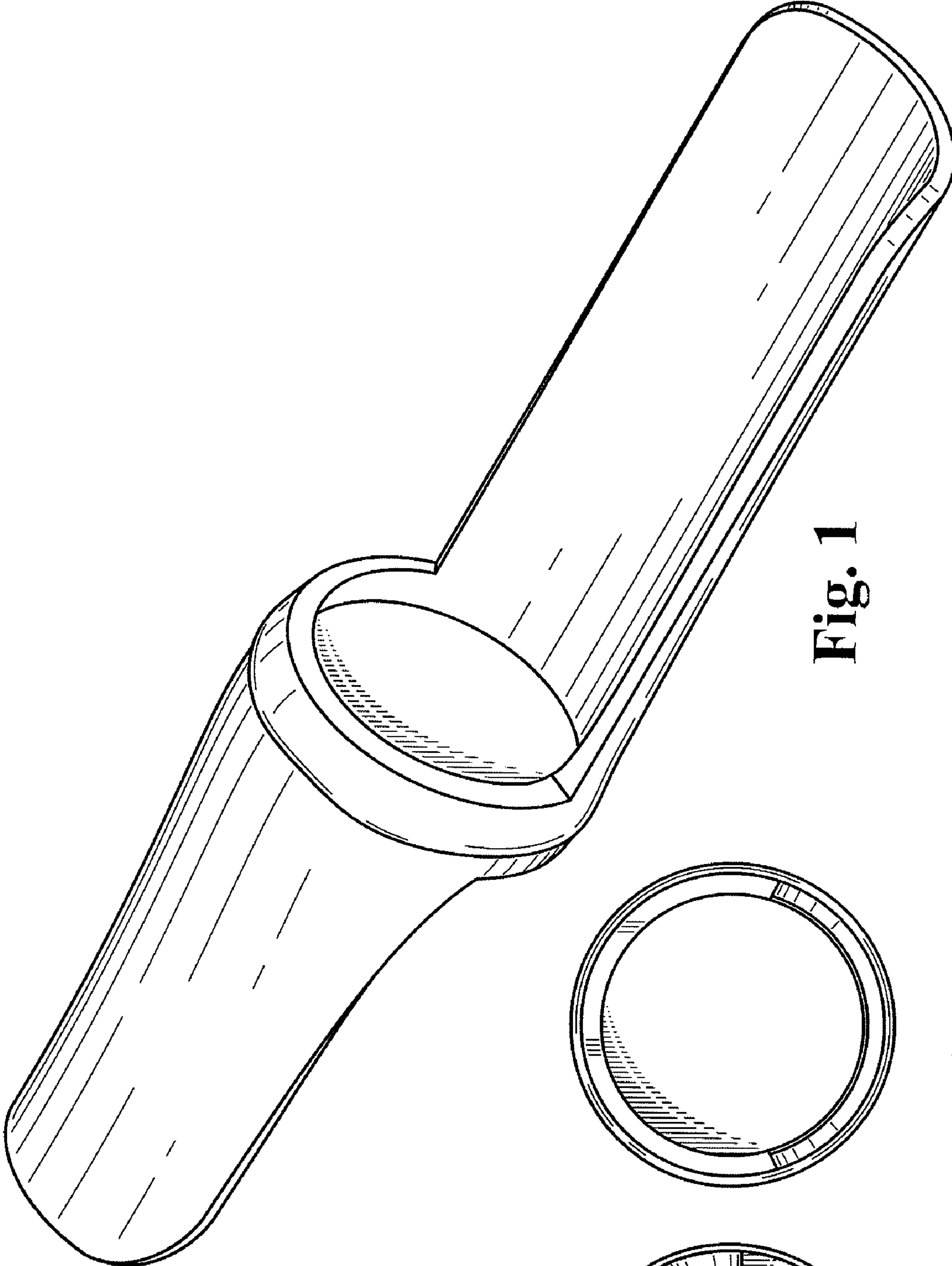

Fig. 1

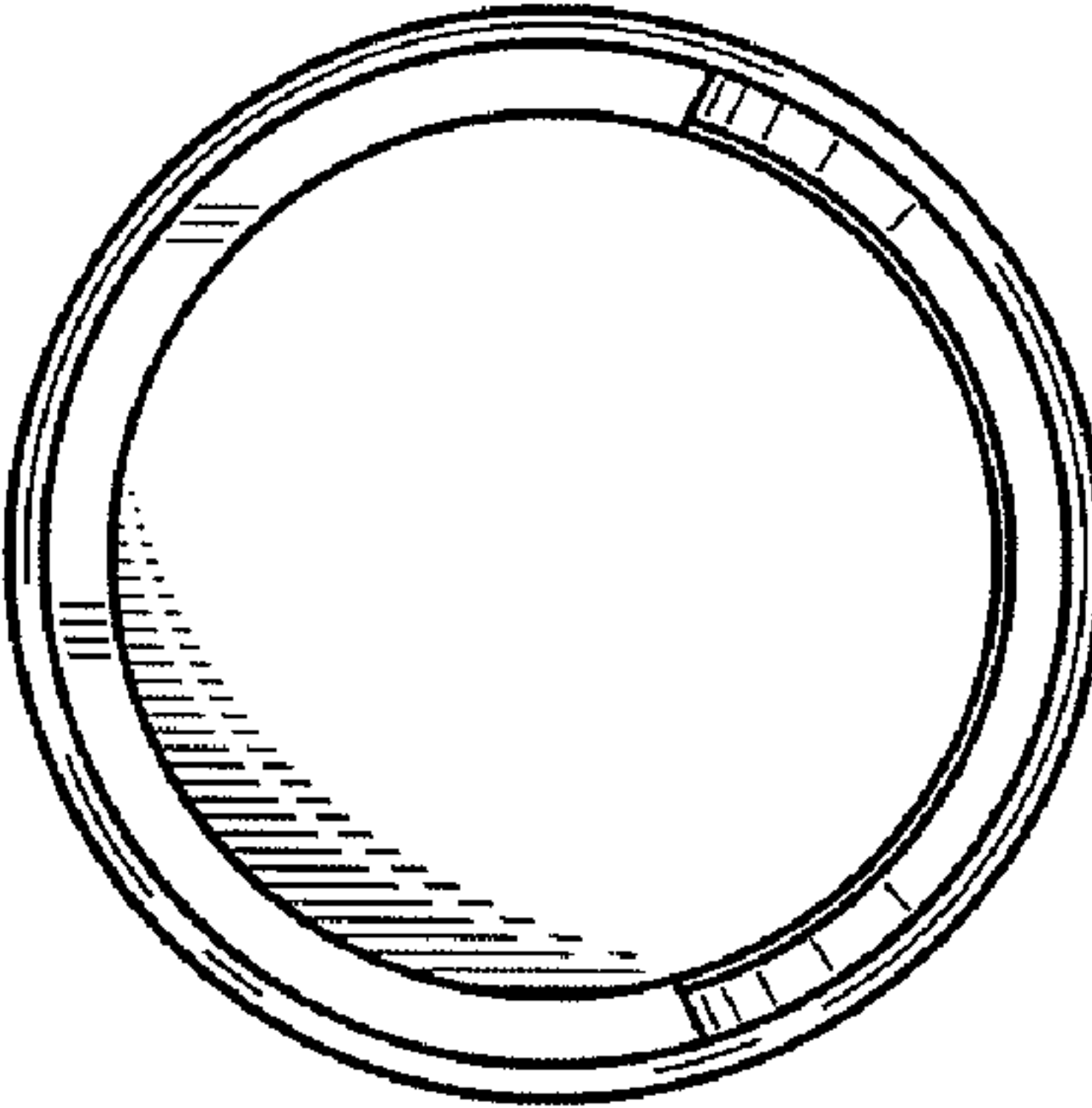

Fig. 2

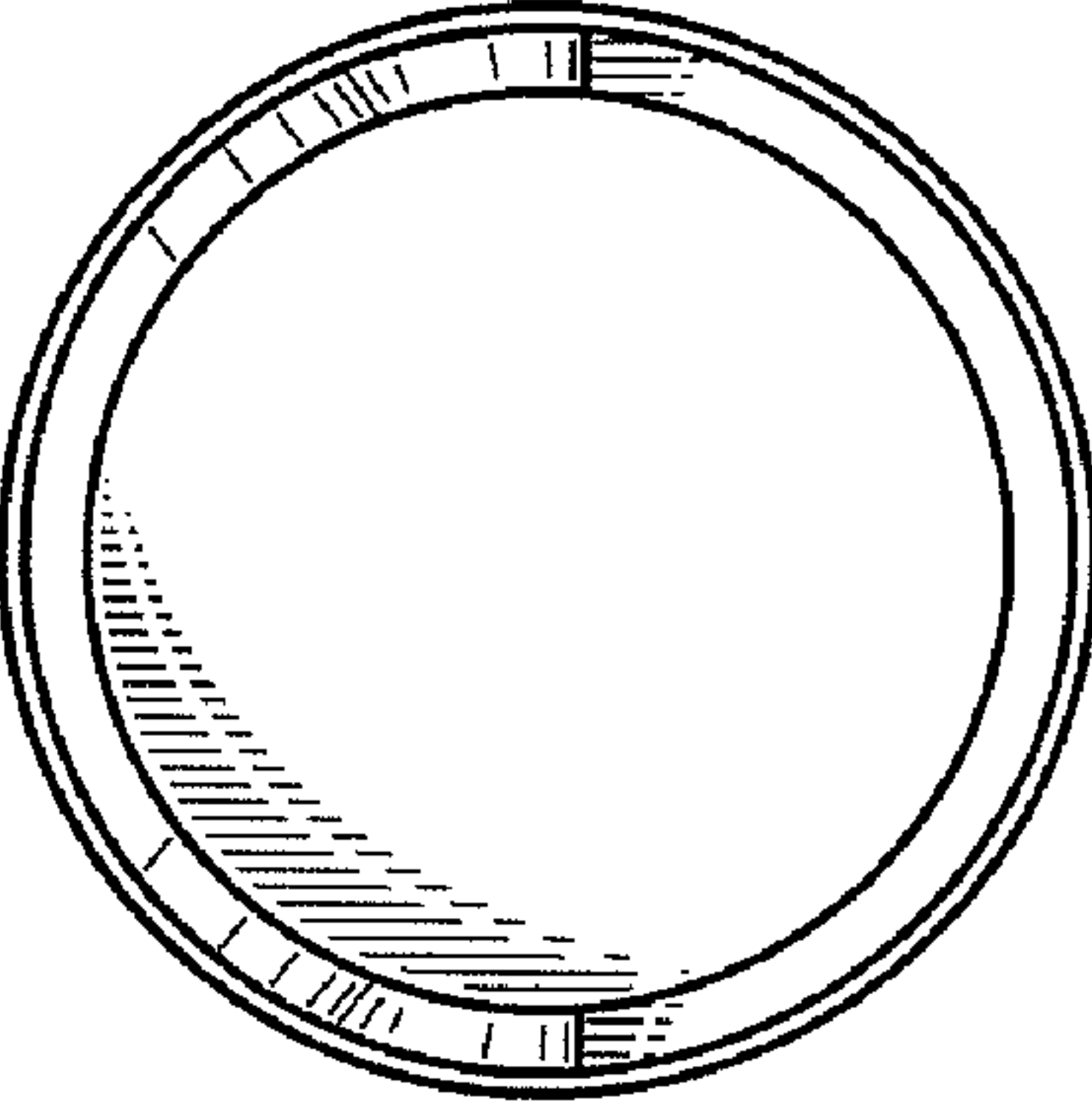

Fig. 3

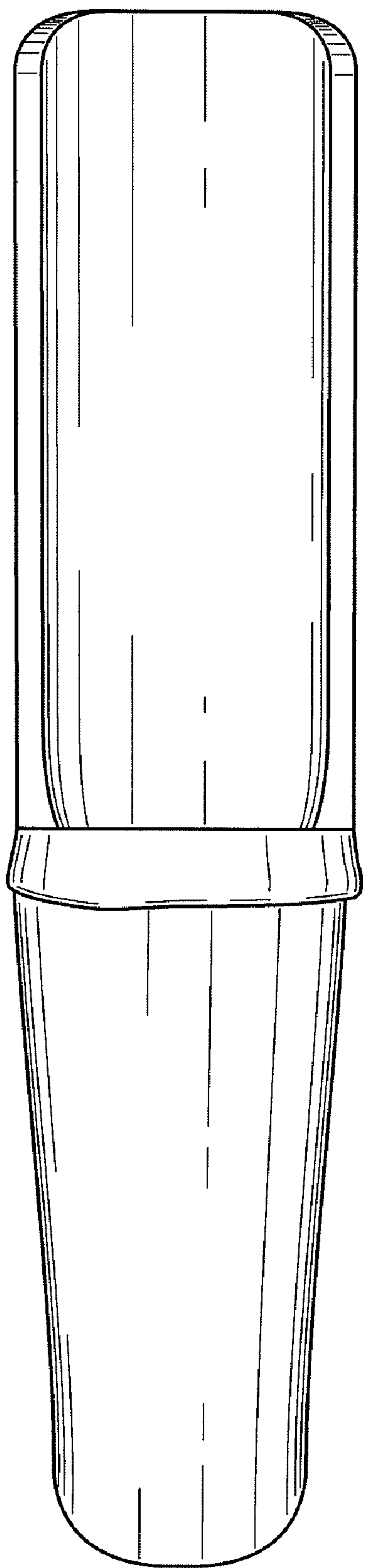

Fig. 4

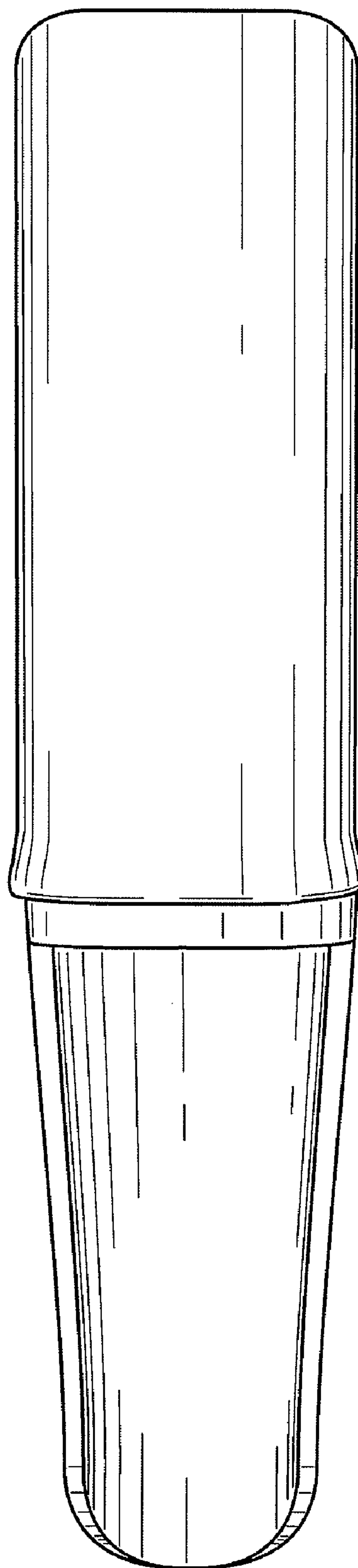

Fig. 5

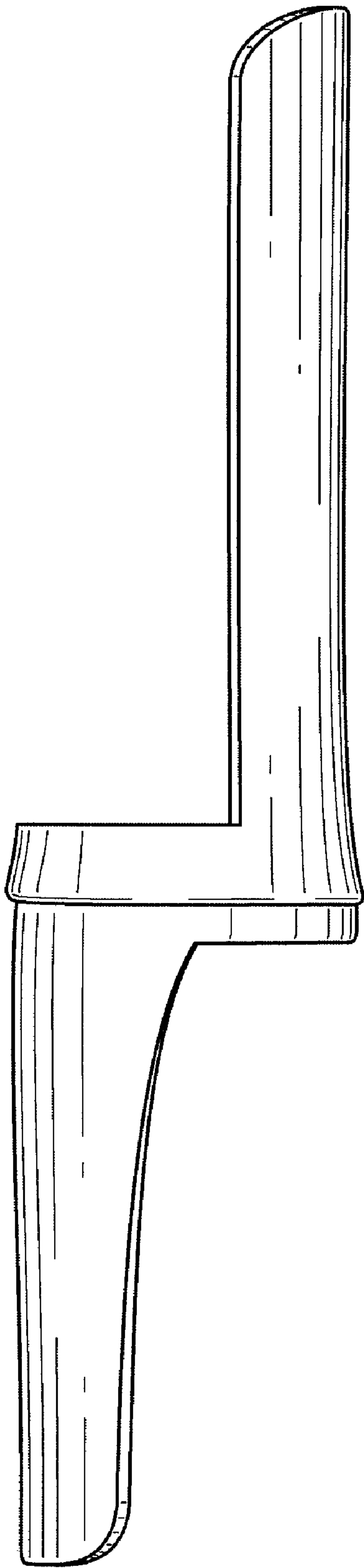

Fig. 6

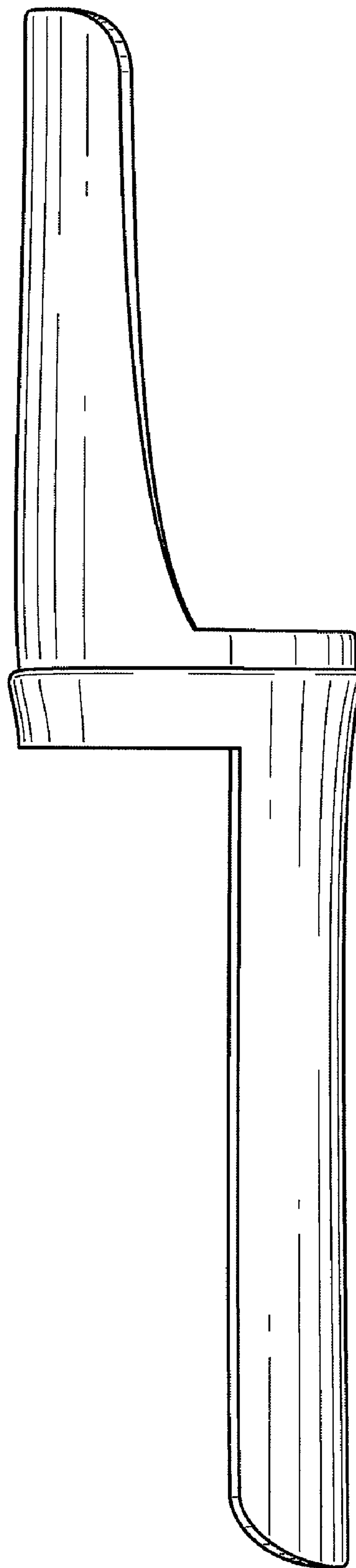

Fig. 7