



US00D603097S

(12) **United States Design Patent**  
**Cataudella**

(10) **Patent No.:** **US D603,097 S**  
(45) **Date of Patent:** **\*\* Oct. 27, 2009**

(54) **SHAVING RAZOR CONNECTOR**

2007/0193042 A1 8/2007 Worrick et al.  
2007/0289139 A1\* 12/2007 Peyser et al. .... 30/47

(75) Inventor: **Matthew Corey Cataudella**, South  
Boston, MA (US)

FOREIGN PATENT DOCUMENTS

(73) Assignee: **The Gillette Company**, Boston, MA  
(US)

WO WO 2006/086314 A1 8/2006

(\*\*) Term: **14 Years**

\* cited by examiner

(21) Appl. No.: **29/329,810**

*Primary Examiner*—Jennifer Rivard  
(74) *Attorney, Agent, or Firm*—John M. Lipchitz; Kevin C.  
Johnson; Steven W. Miller

(22) Filed: **Dec. 22, 2008**

(57) **CLAIM**

(51) **LOC (9) Cl.** ..... **28-03**

The ornamental design for a shaving razor connector, as  
shown and described.

(52) **U.S. Cl.** ..... **D28/47**

(58) **Field of Classification Search** ..... 30/32,  
30/34.05, 34.1, 34.2, 41–41.8, 44–45, 47–51,  
30/53–58, 526–533, 537; D28/44.1–48  
See application file for complete search history.

**DESCRIPTION**

(56) **References Cited**

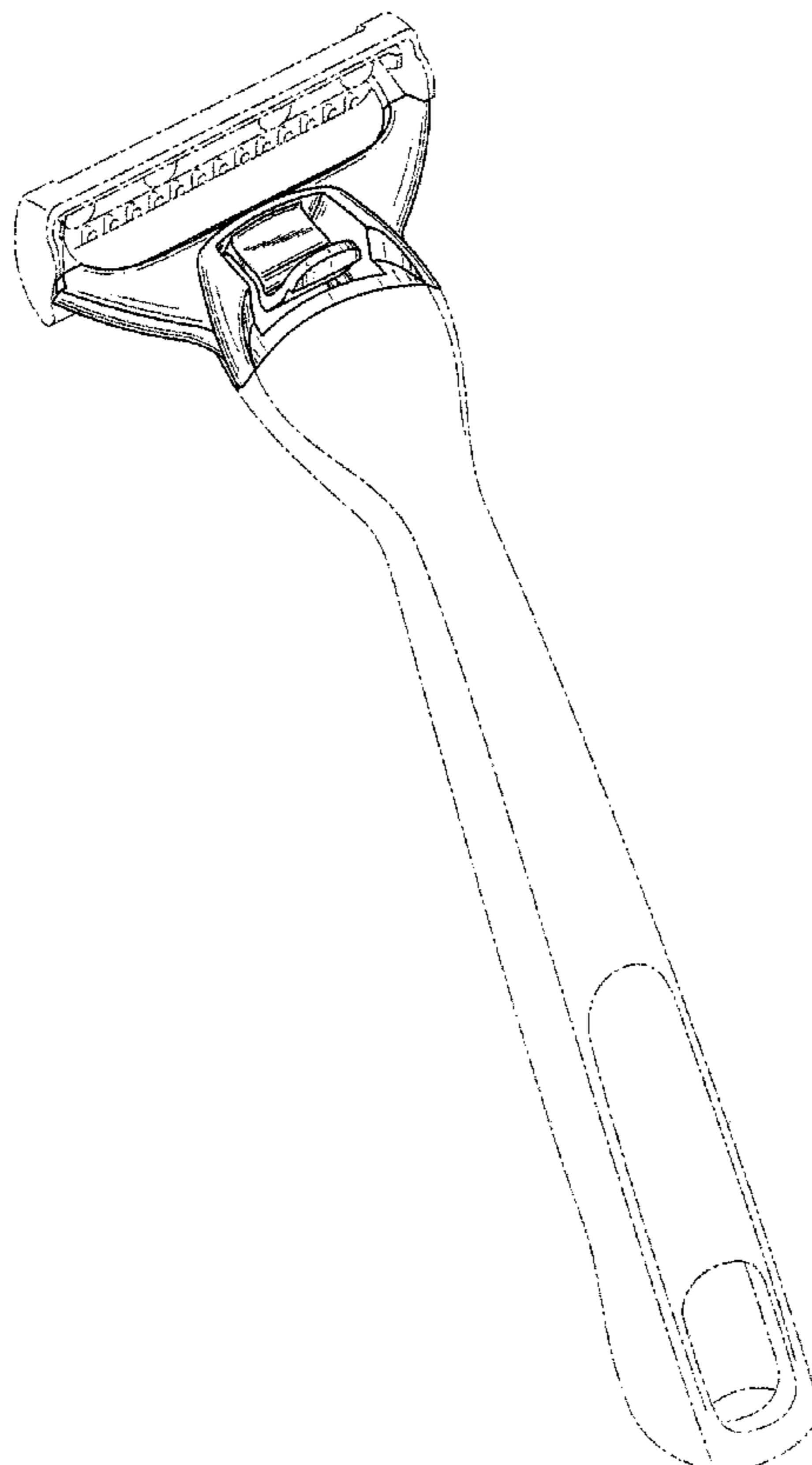
FIG. 1 is a perspective view of a shaving razor connector of  
the present invention;  
FIG. 2 is a left side elevational view thereof;  
FIG. 3 is a top plan view thereof;  
FIG. 4 is a bottom plan view thereof;  
FIG. 5 is a right side elevational view thereof;  
FIG. 6 is a front elevational view thereof; and,  
FIG. 7 is a rear elevational view thereof.

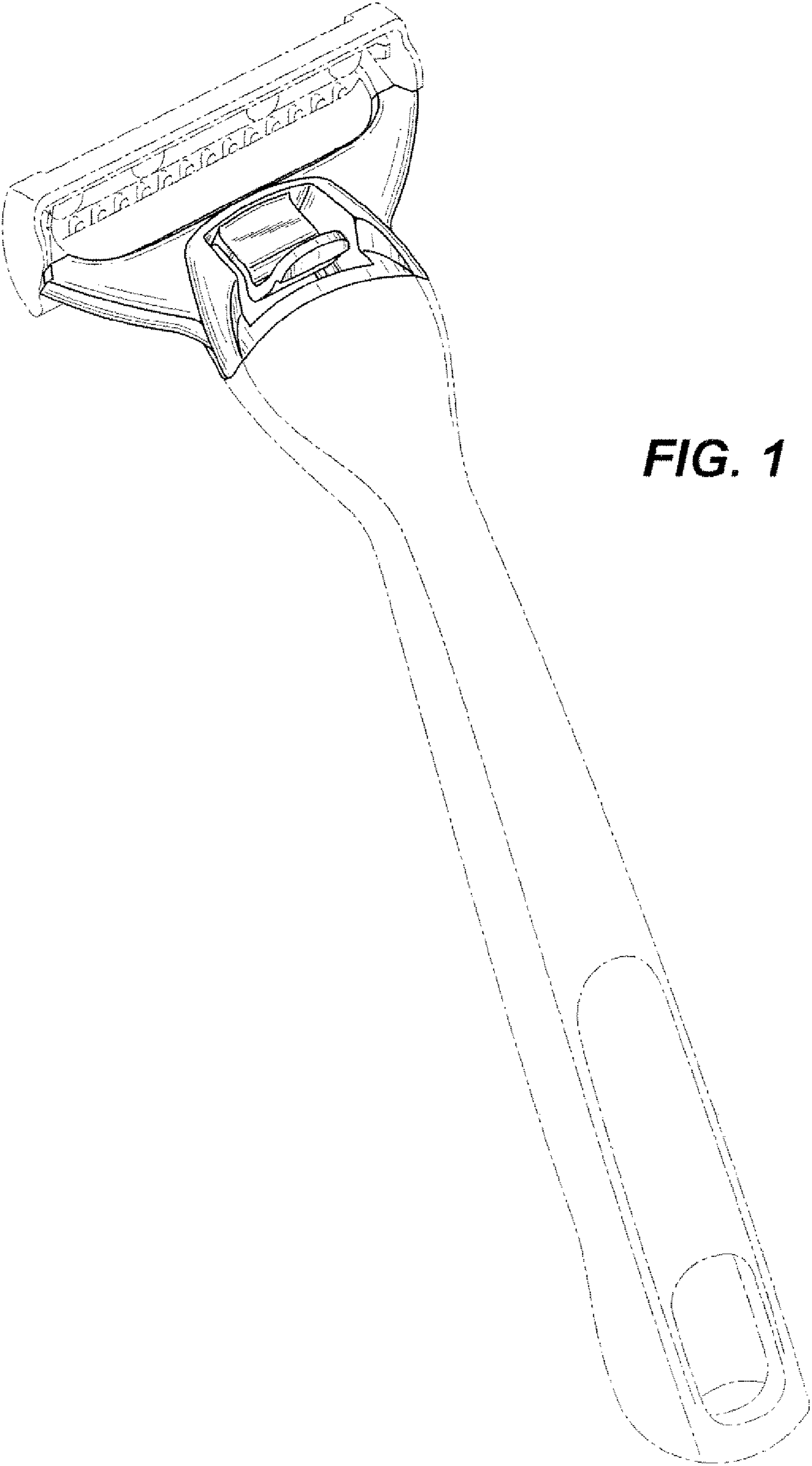
U.S. PATENT DOCUMENTS

5,331,740	A	7/1994	Carson, III et al.	
5,855,071	A	1/1999	Apprille, Jr. et al.	
6,584,696	B2	7/2003	Ferraro	
D535,784	S *	1/2007	Wonderley et al. ....	D28/47
D542,471	S *	5/2007	Bunnell et al. ....	D28/48
D542,472	S *	5/2007	Sakurai .....	D28/48
D565,245	S *	3/2008	Wonderley .....	D28/46
D588,308	S *	3/2009	Wonderley .....	D28/46
D588,309	S *	3/2009	Wonderley .....	D28/47

The broken lines are shown for illustrative purposes only and  
form no part of the claimed design.

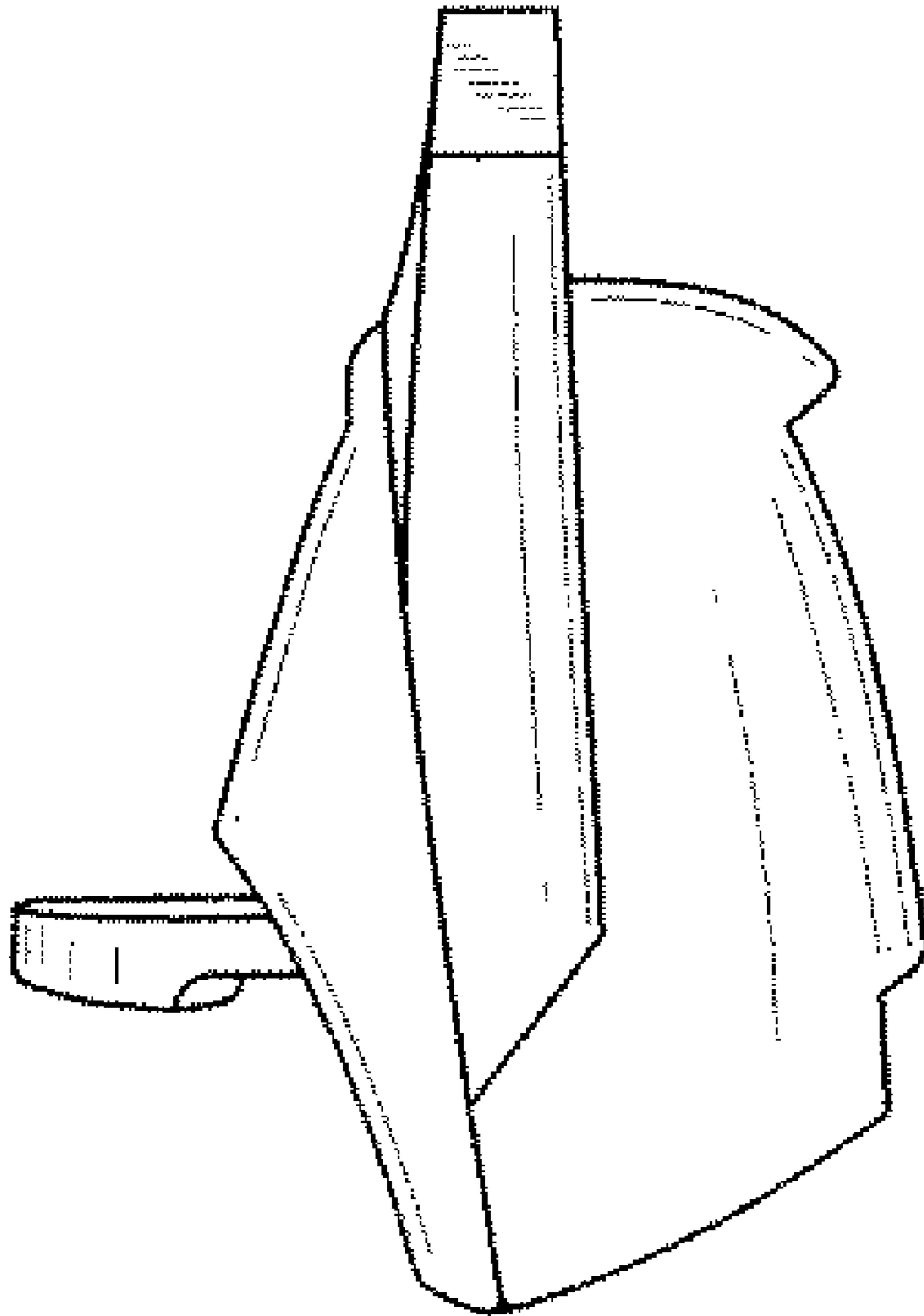
**1 Claim, 5 Drawing Sheets**



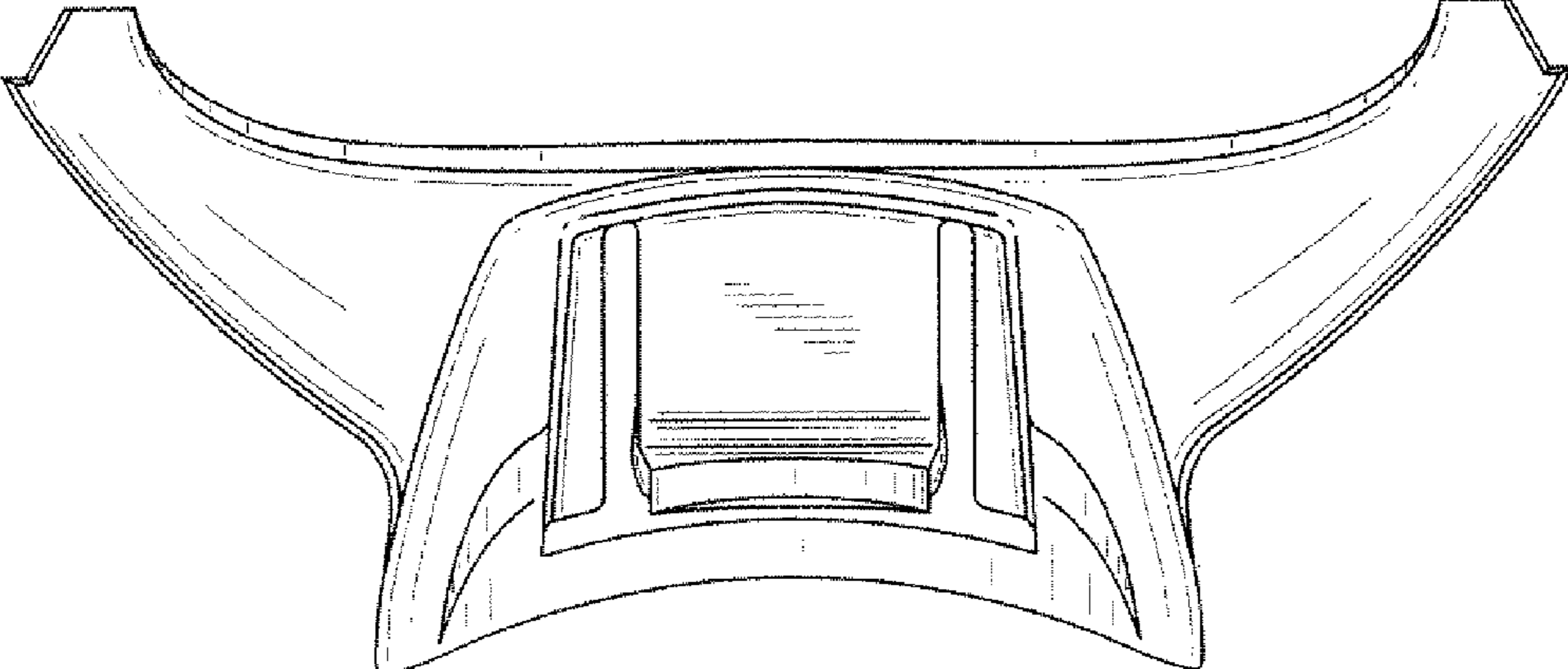


**FIG. 1**

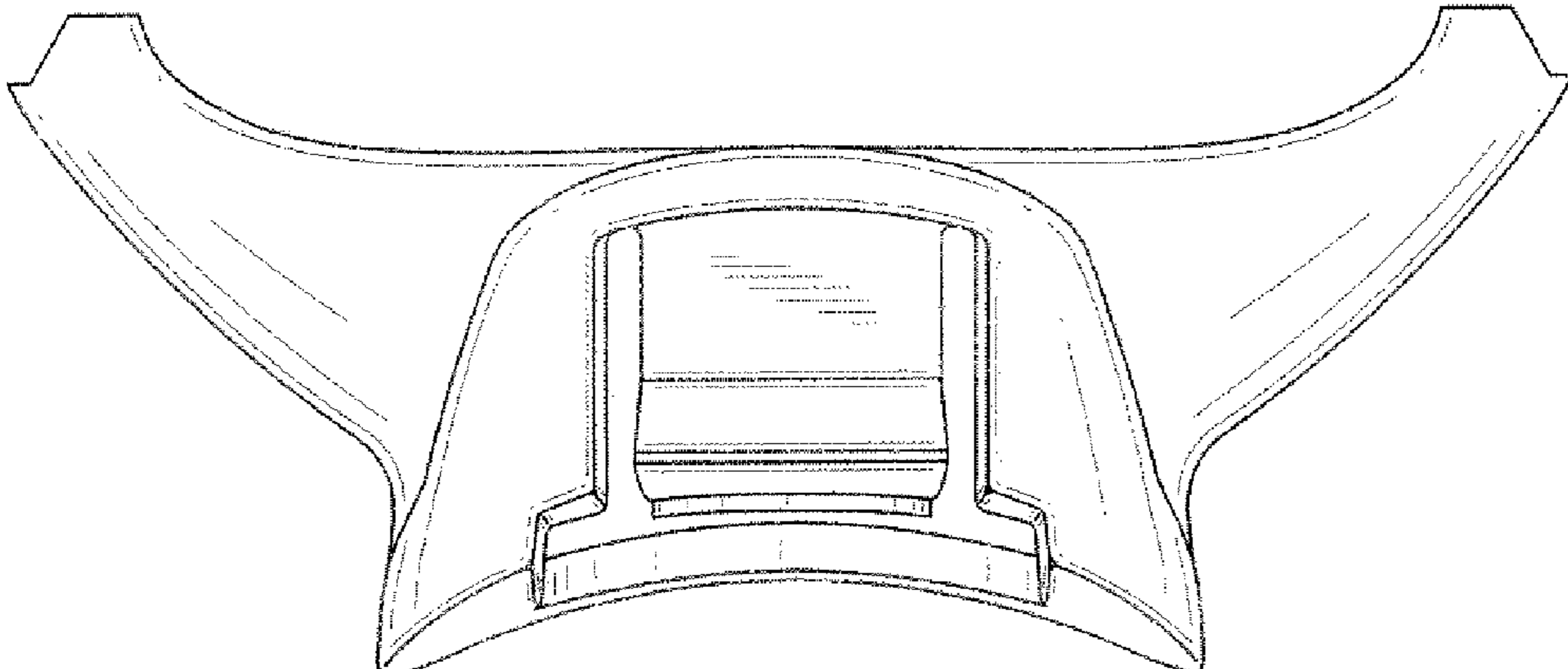
# FIG. 2



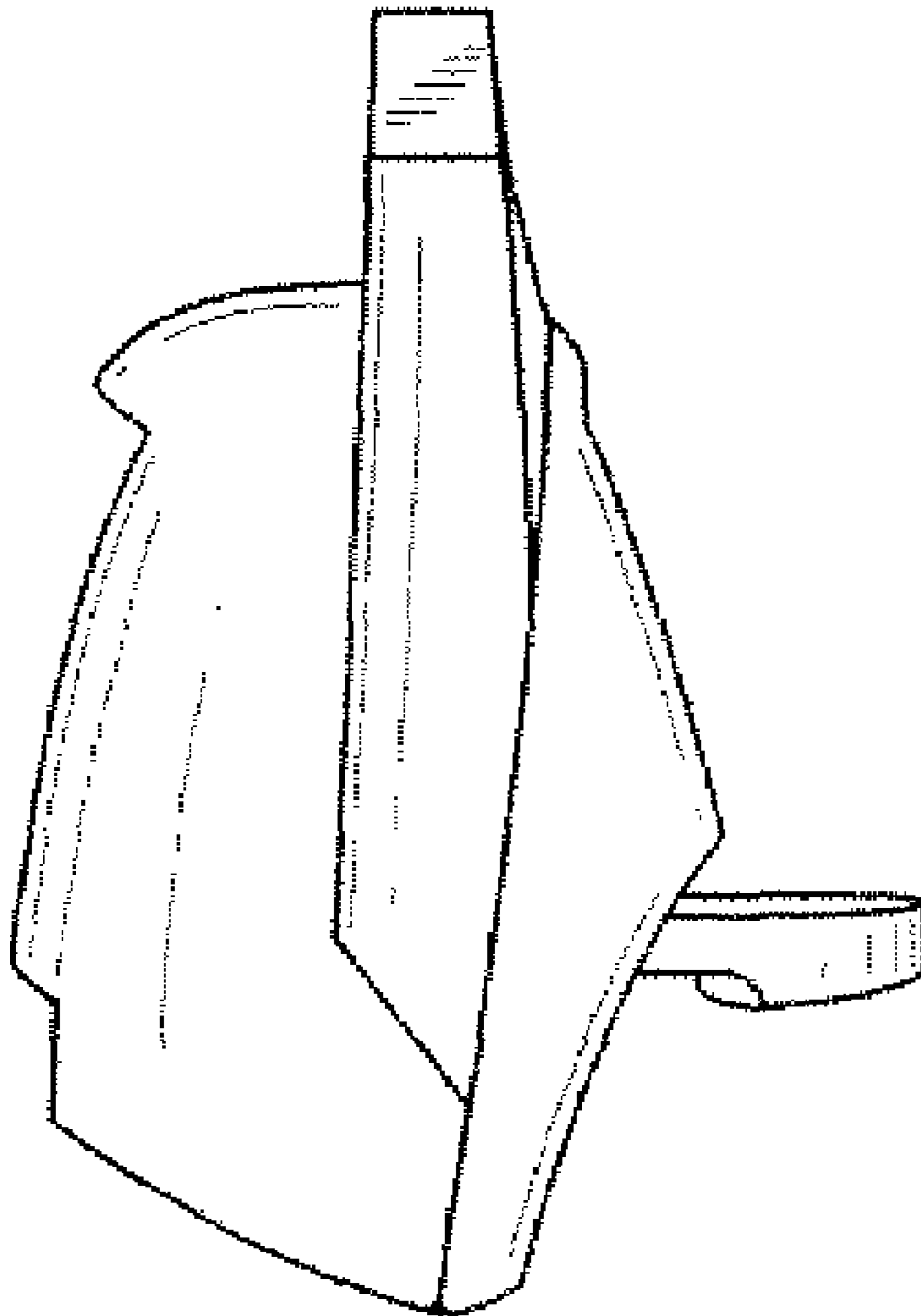
**FIG. 3**



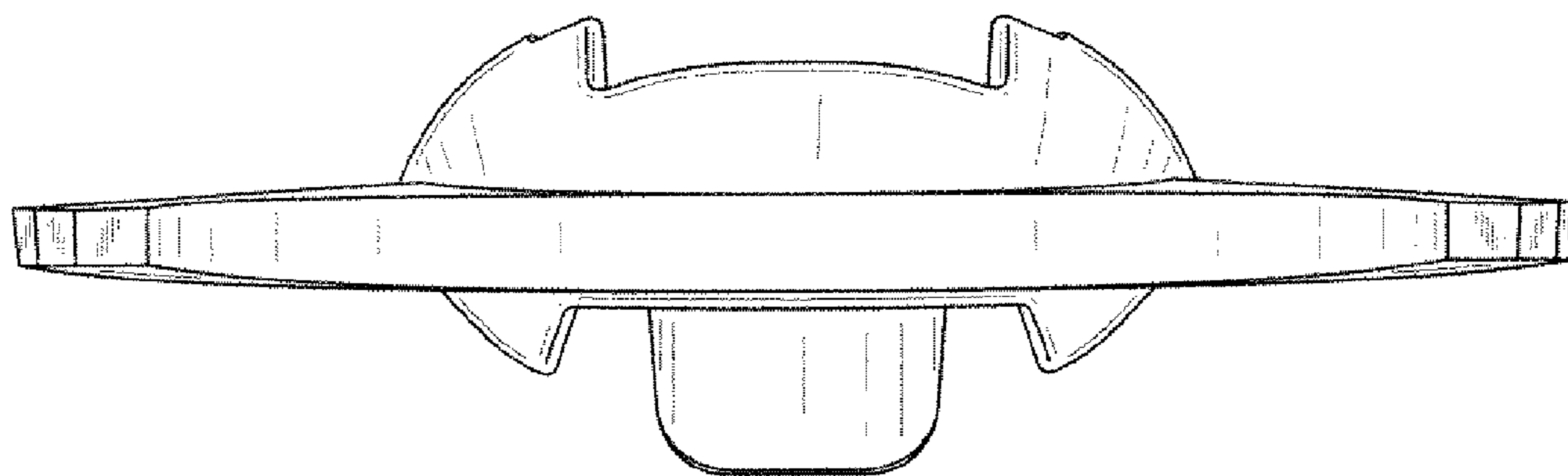
**FIG. 4**



# FIG. 5



**FIG. 6**



**FIG. 7**

