



US00D603046S

(12) **United States Design Patent**
Frey

(10) **Patent No.:** **US D603,046 S**
(45) **Date of Patent:** **** Oct. 27, 2009**

(54) **MEDICAL INSTRUMENT**

(75) Inventor: **Sebastian Frey,**
Villingen-Schwenningen (DE)

(73) Assignee: **Karl Storz GmbH & Co. KG** (DE)

(**) Term: **14 Years**

(21) Appl. No.: **29/299,999**

(22) Filed: **Jan. 8, 2008**

(30) **Foreign Application Priority Data**

Jul. 11, 2007 (EM) 000756267

(51) **LOC (9) Cl.** **24-02**

(52) **U.S. Cl.** **D24/146; D24/133; D24/147**

(58) **Field of Classification Search** D24/135,
D24/136, 133, 146, 147, 140; 600/131, 210,
600/227, 114, 164, 129, 183, 127, 104, 176;
604/167.06, 523, 192, 263, 159, 117; 606/167
See application file for complete search history.

(56) **References Cited**

U.S. PATENT DOCUMENTS

D429,331 S * 8/2000 Koros et al. D24/135
D430,668 S * 9/2000 Koros et al. D24/135
D469,871 S * 2/2003 Sand D24/133
6,648,815 B2 * 11/2003 Schoellhorn et al. 600/164
D496,728 S * 9/2004 Holsinger D24/130
6,860,850 B2 * 3/2005 Phillips et al. 600/227
D510,768 S * 10/2005 Farley D24/135
D582,552 S * 12/2008 Berberich D24/146
D585,989 S * 2/2009 Leroy D24/146
7,485,092 B1 * 2/2009 Stewart et al. 600/127

D590,945 S * 4/2009 Berberich D24/146
2002/0156348 A1 * 10/2002 Schoellhorn et al. 600/164
2008/0086034 A1 * 4/2008 Schmitz et al. 600/210
2009/0048622 A1 * 2/2009 Wilson 606/190

OTHER PUBLICATIONS

Arthroscopy 2nd Edition Jan. 2003 (p. CTS 11).
Plastische Chirurgie, 1. Ausgabe Jan. 2004 (p. 27).

* cited by examiner

Primary Examiner—Ian Simmons

Assistant Examiner—Christopher Lee

(74) *Attorney, Agent, or Firm*—St. Onge Steward Johnston &
Reens LLC

(57) **CLAIM**

The ornamental design for a medical instrument, as shown
and described.

DESCRIPTION

FIG. 1 is a front perspective view of a medical instrument in
accordance with the new design;

FIG. 2 is a bottom view thereof;

FIG. 3 is a top view thereof;

FIG. 4 is a right side view thereof;

FIG. 5 is a left side view thereof;

FIG. 6 is a front view thereof; and,

FIG. 7 is a rear view thereof.

The broken lines in FIG. 7 are included for the purpose of
illustrating a portion of the medical instrument that forms no
part of the claimed design.

1 Claim, 7 Drawing Sheets

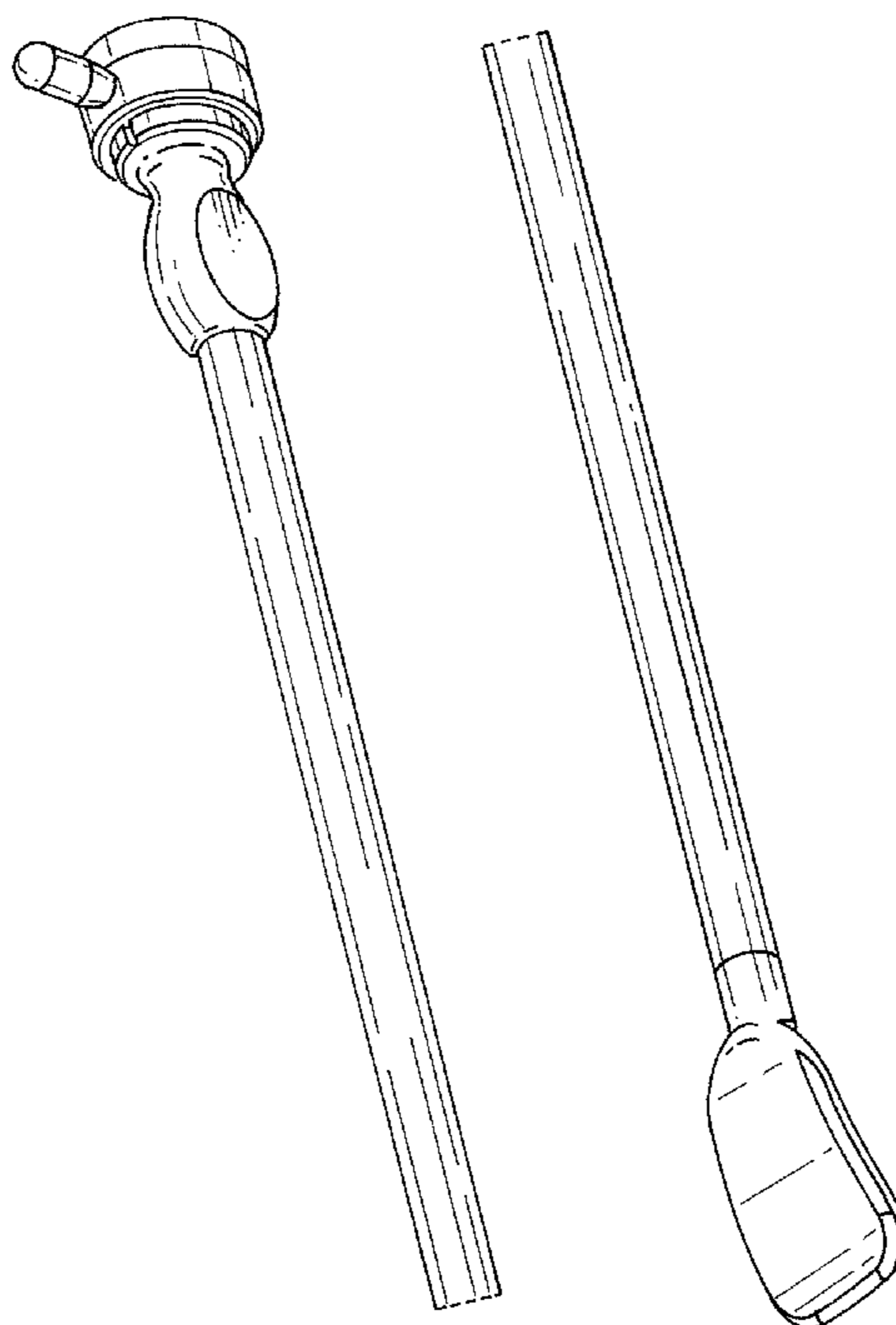

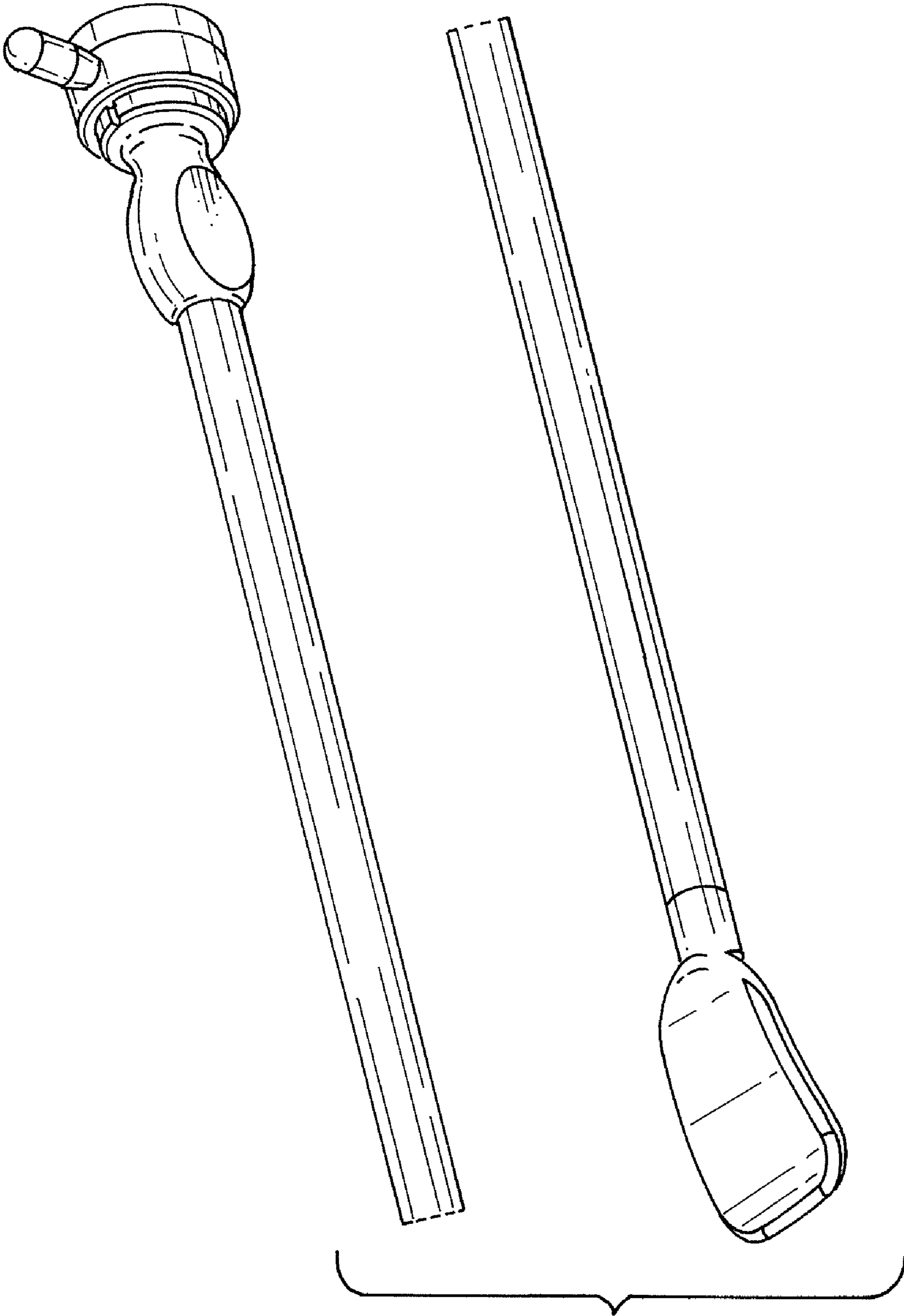

FIG. 1

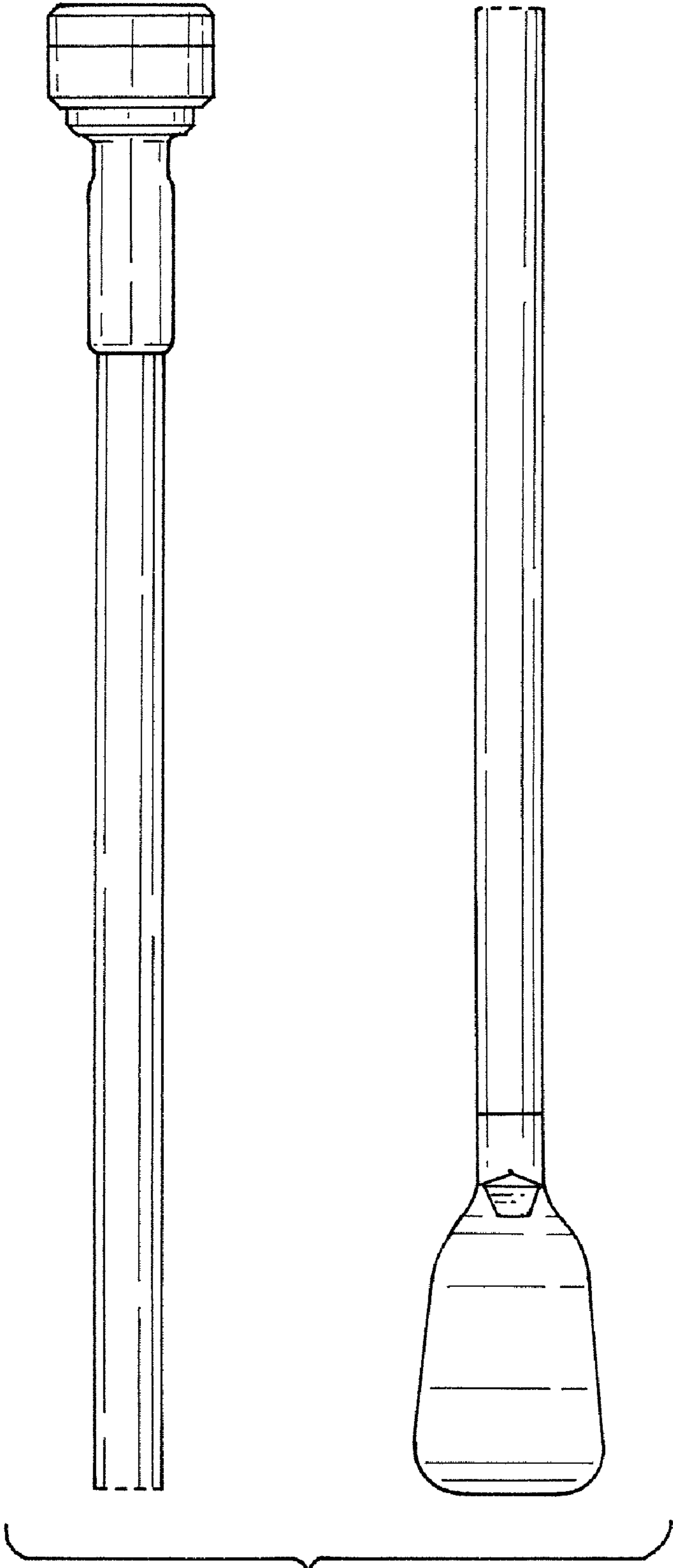

FIG. 2

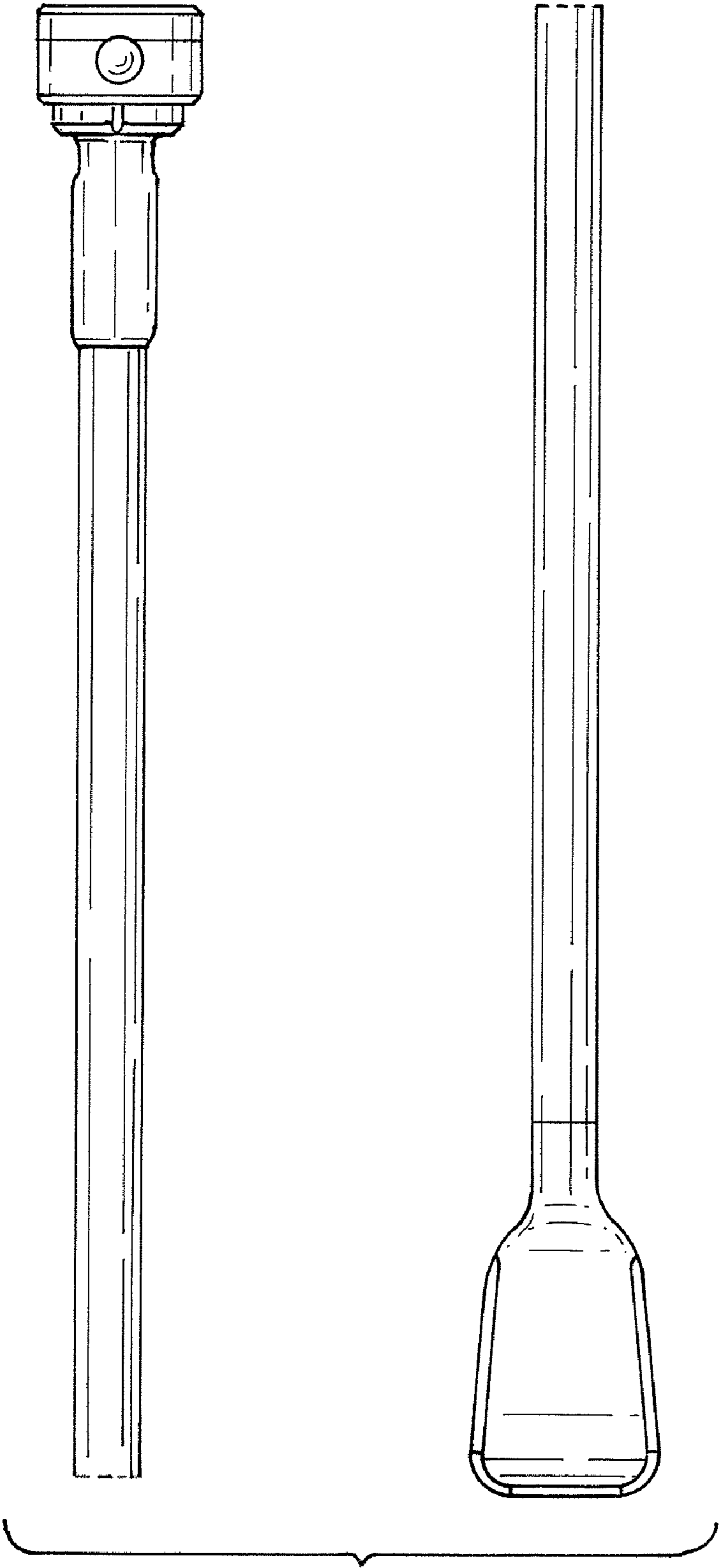

FIG. 3

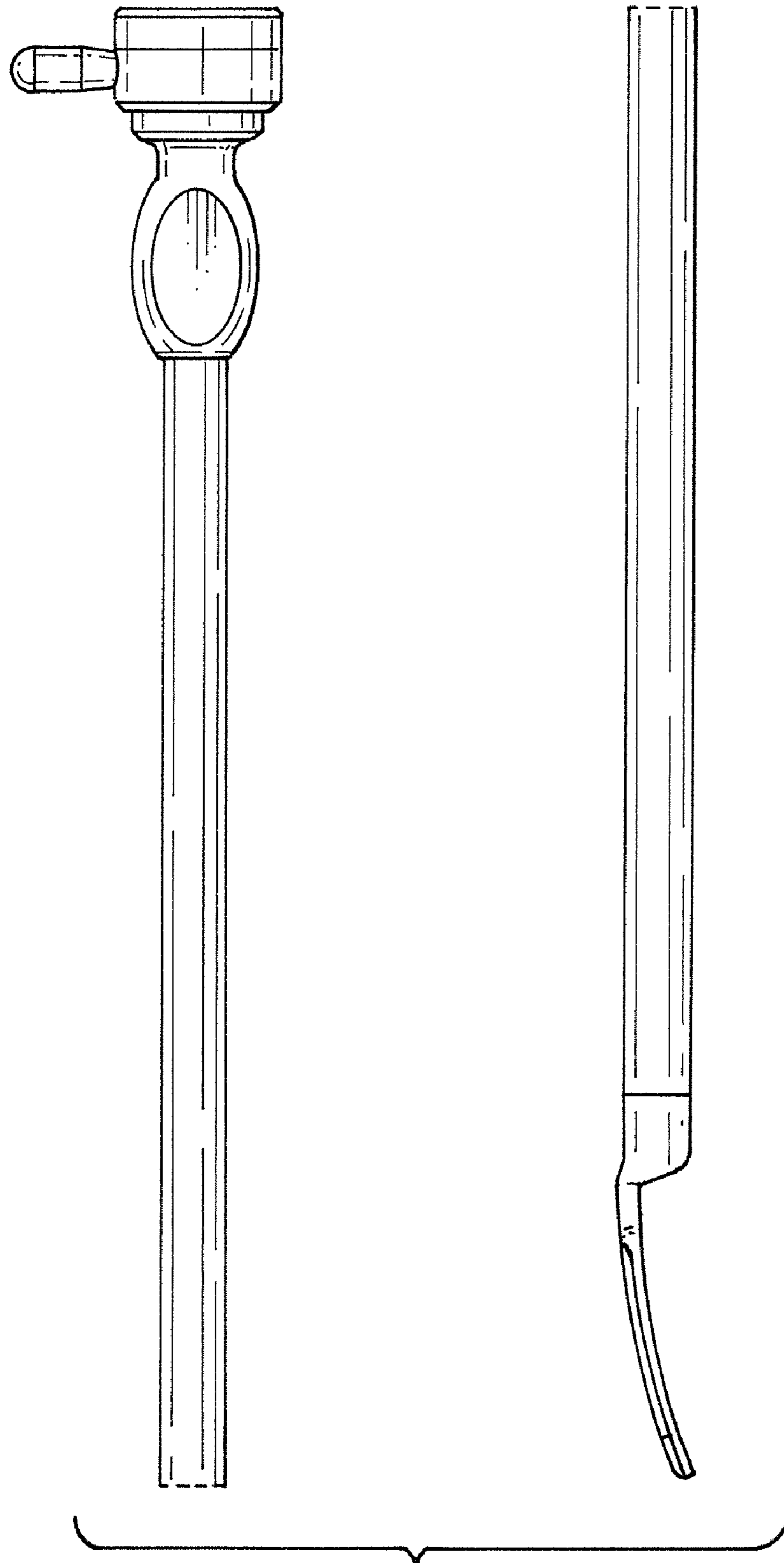

FIG. 4

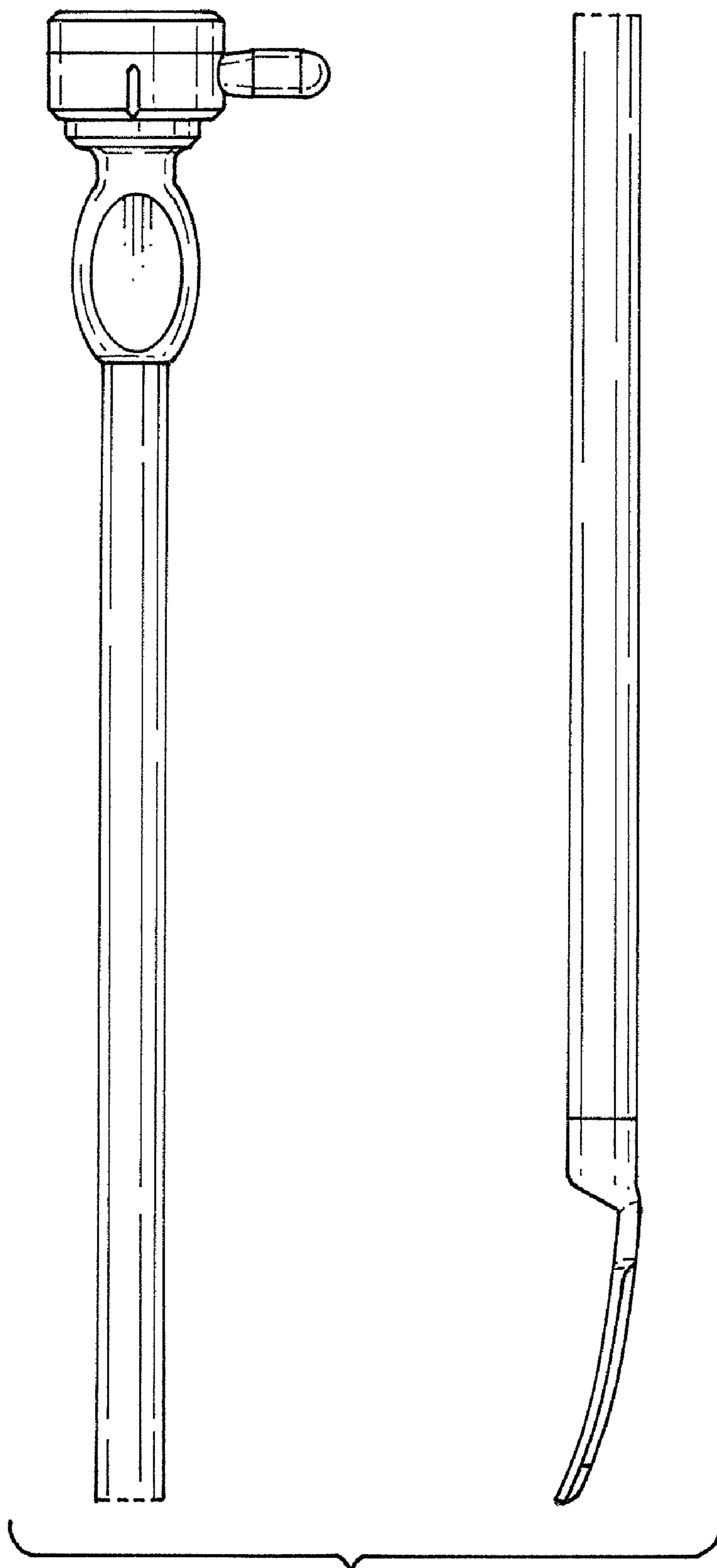

FIG. 5

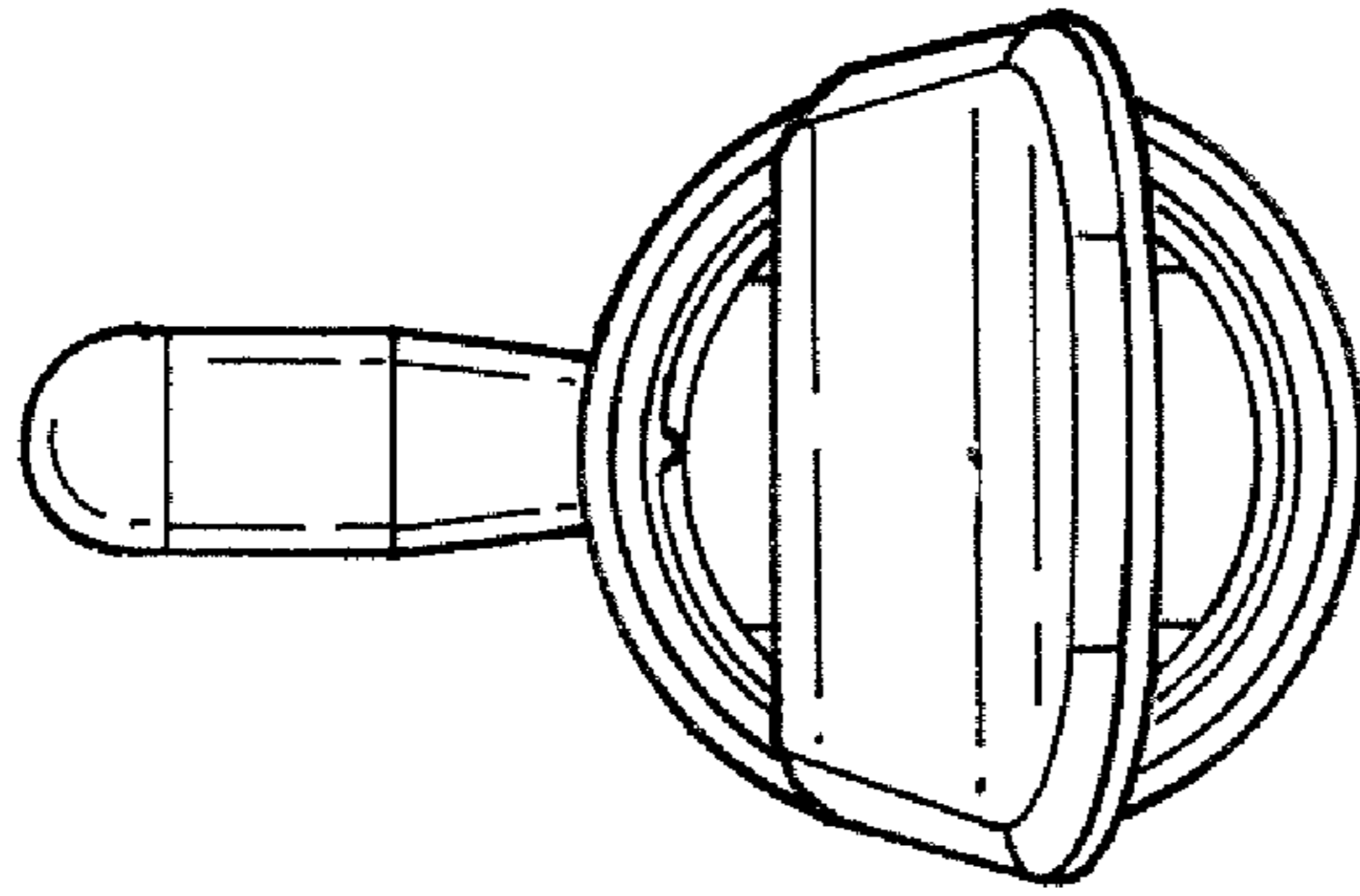

FIG. 6

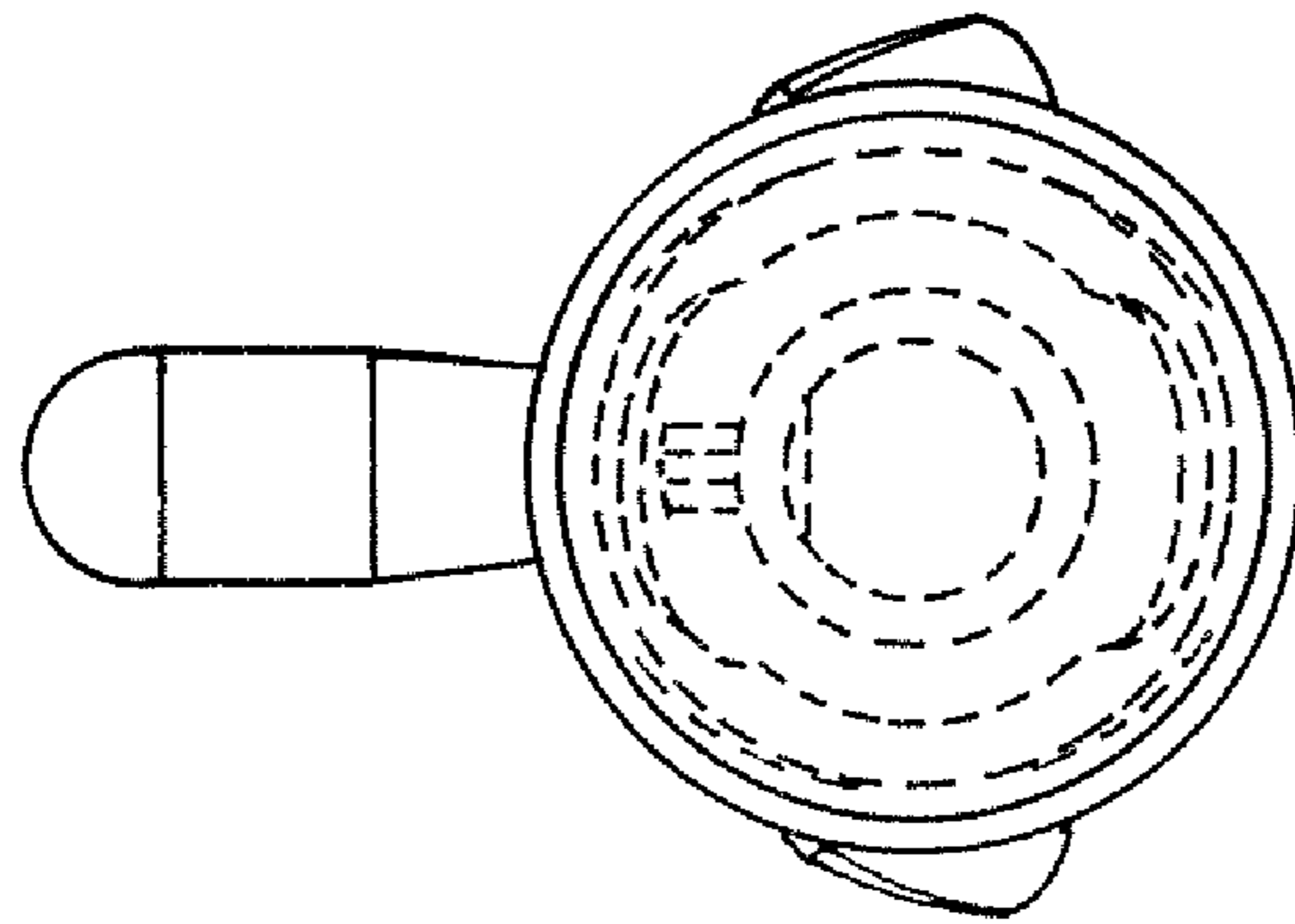

FIG. 7