



US00D602905S

(12) **United States Design Patent**
Morisawa

(10) **Patent No.:** **US D602,905 S**
(45) **Date of Patent:** **** Oct. 27, 2009**

(54) **EARPHONE**

(75) Inventor: **Rui Morisawa**, Tokyo (JP)

(73) Assignee: **Sony Corporation**, Tokyo (JP)

(**) Term: **14 Years**

(21) Appl. No.: **29/309,837**

(22) Filed: **Oct. 23, 2008**

(30) **Foreign Application Priority Data**

Apr. 24, 2008 (JP) 2008-010606
Apr. 24, 2008 (JP) 2008-010607

(51) **LOC (9) Cl.** **14-01**

(52) **U.S. Cl.** **D14/205; D14/223**

(58) **Field of Classification Search** D14/205,
D14/206, 223; 379/420.01, 430; 181/129,
181/130, 135; 381/322, 324, 328, 329, 330,
381/380, 381, 370, 312; D24/174; 128/865
See application file for complete search history.

(56) **References Cited**

U.S. PATENT DOCUMENTS

D431,553 S 10/2000 Suzuki
D457,515 S 5/2002 Masamitsu et al.
D474,171 S 5/2003 Suzuki
D485,548 S 1/2004 Obata
D487,077 S 2/2004 Obata
6,738,487 B1 * 5/2004 Nageno et al. 381/322
D539,268 S * 3/2007 Suzuki D14/206
D542,782 S * 5/2007 Pena Angarita D14/223
D554,627 S * 11/2007 Gondo D14/223
D555,152 S * 11/2007 Wang D14/223
D564,495 S * 3/2008 Sasaki D14/205
D567,217 S * 4/2008 Kamo et al. D14/205

D572,703 S * 7/2008 Ledbetter et al. D14/205
D574,361 S * 8/2008 Sasaki D14/205
D576,154 S * 9/2008 Ledbetter et al. D14/223
D579,005 S * 10/2008 Wilhelmsen D14/223
D579,444 S * 10/2008 Ewert et al. D14/223
D586,332 S * 2/2009 Ewert et al. D14/223
D587,247 S * 2/2009 Densho D14/223
D587,249 S * 2/2009 Densho D14/223
D587,681 S * 3/2009 Yanai D14/205
D587,685 S * 3/2009 Densho D14/206

* cited by examiner

Primary Examiner—Paula Greene

(74) *Attorney, Agent, or Firm*—Rader, Fishman & Grauer, PLLC

(57) **CLAIM**

The ornamental design for an earphone, as shown and described.

DESCRIPTION

FIG. 1 is a front right top perspective view of an earphone showing my new design;

FIG. 2 is a rear left top perspective view thereof;

FIG. 3 is a front elevational view thereof;

FIG. 4 is a rear elevational view thereof;

FIG. 5 is a left side elevational view thereof;

FIG. 6 is a right side elevational view thereof;

FIG. 7 is a top plan view thereof; and,

FIG. 8 is a bottom plan view thereof.

Portions of the figures that are shown as broken lines are for illustrative purpose only and form no part of the claimed design.

1 Claim, 8 Drawing Sheets

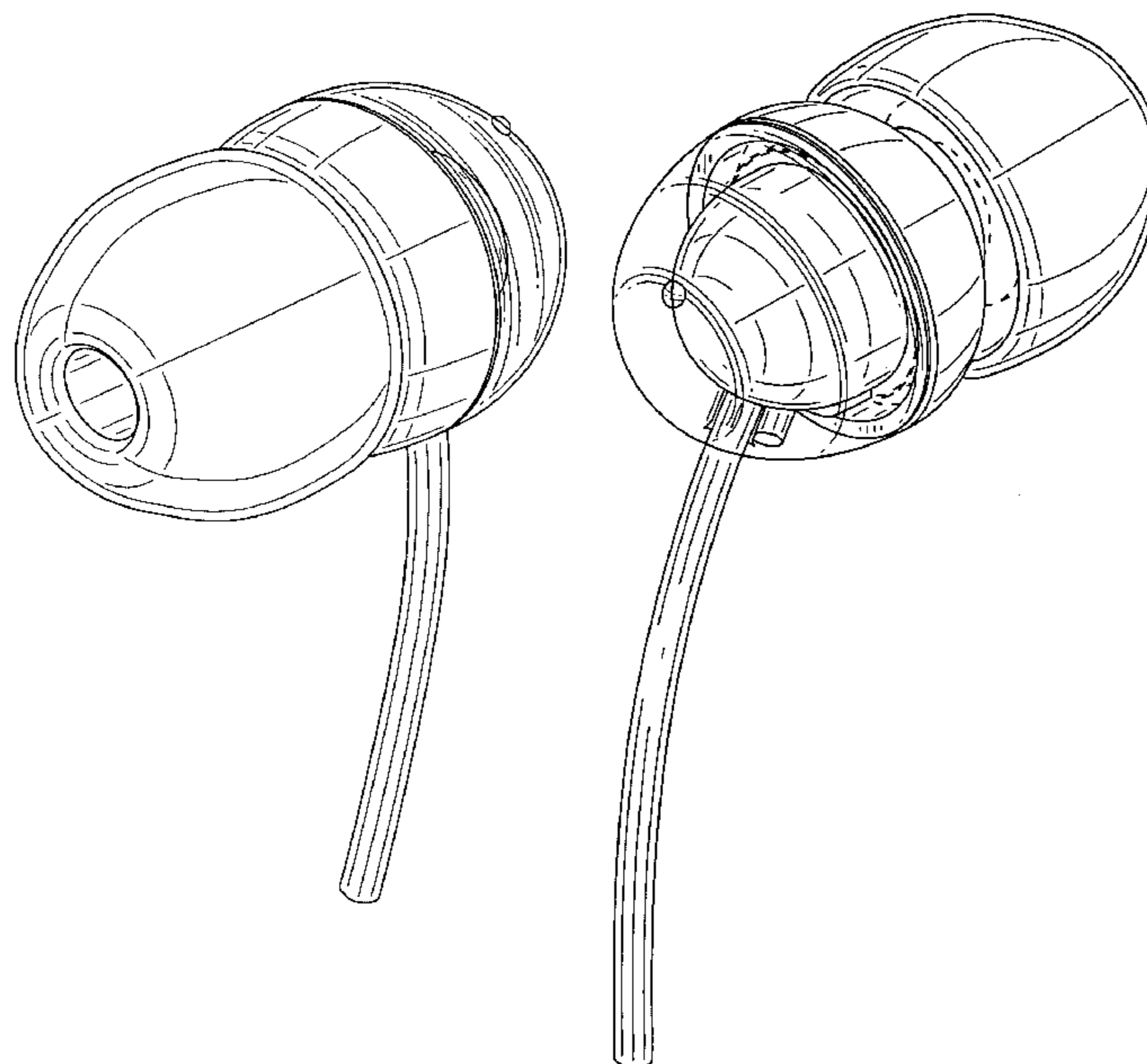

FIG.1

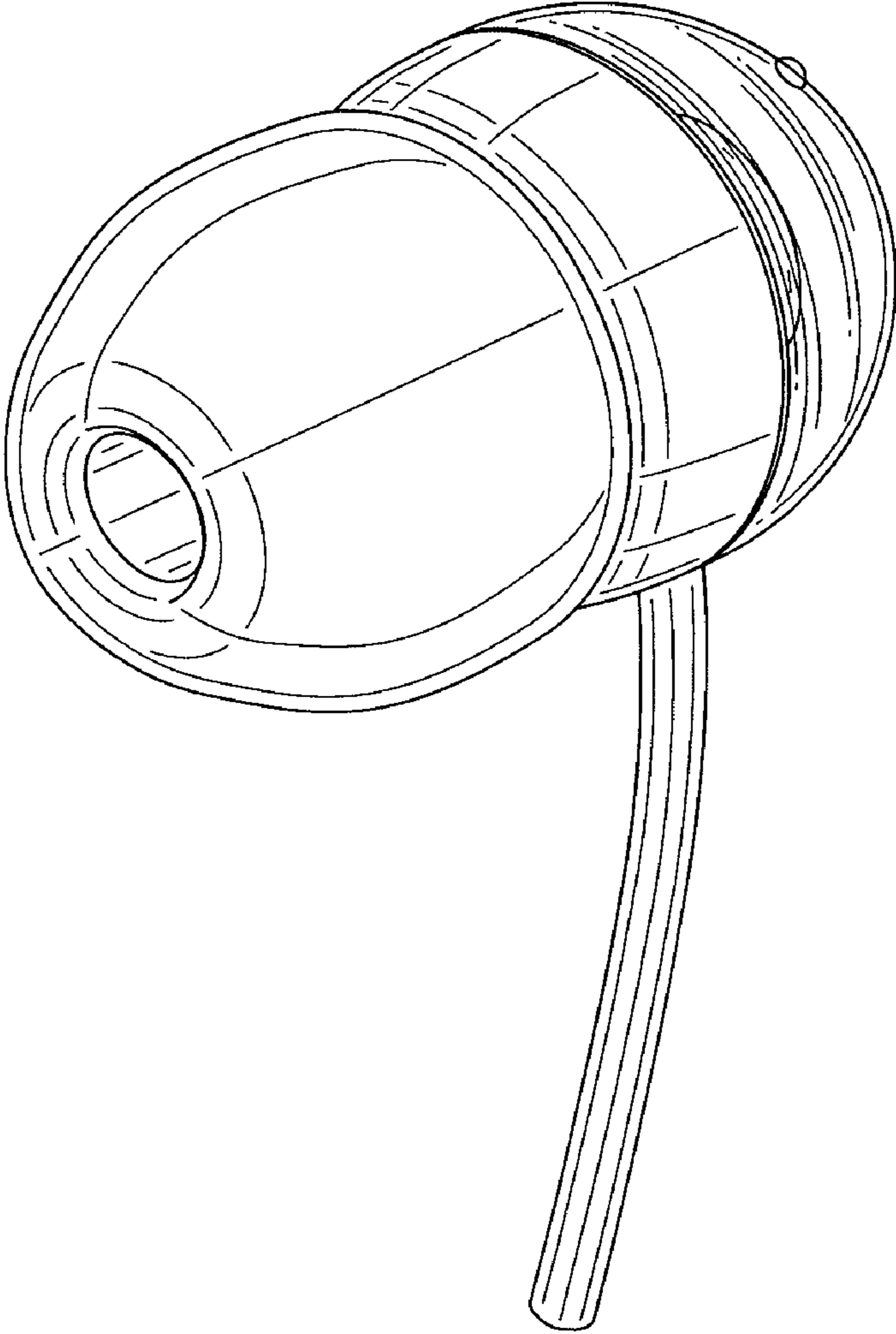

FIG.2

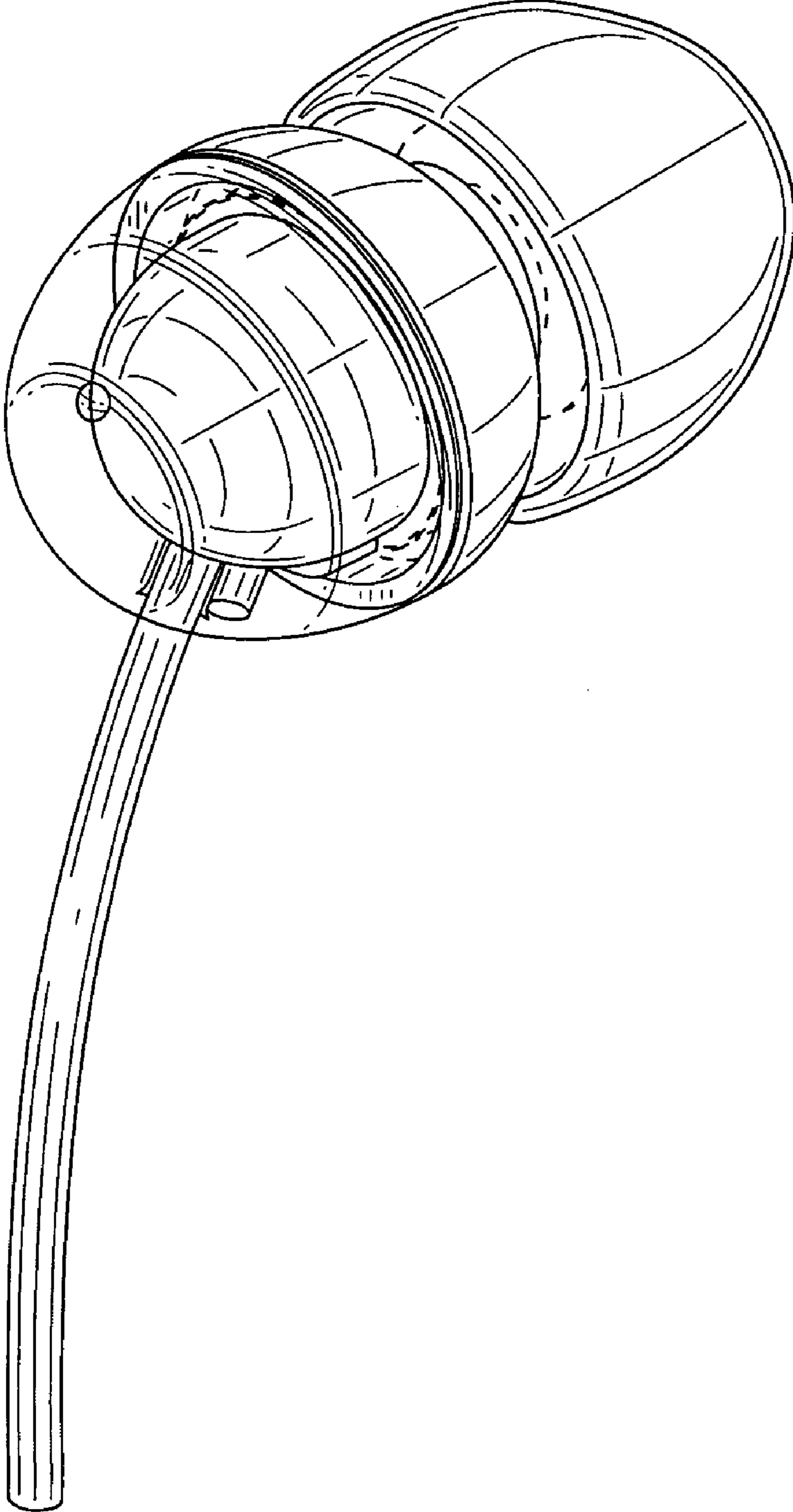

FIG.3

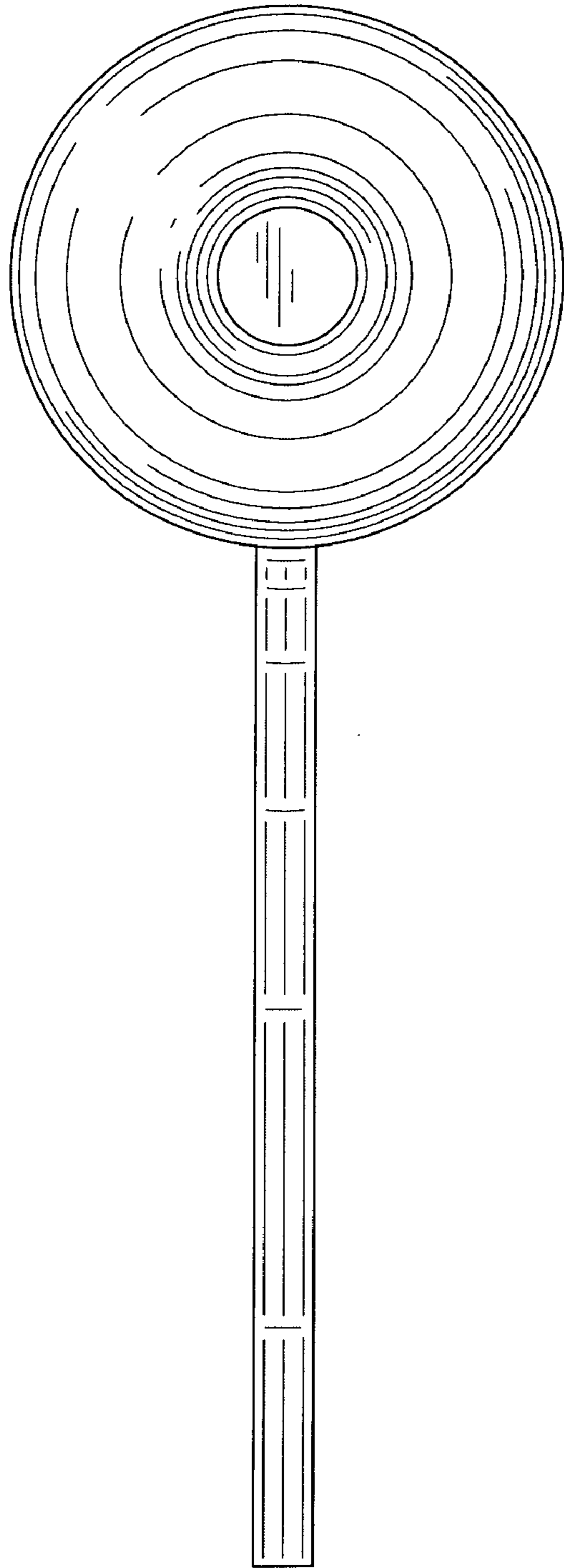

FIG.4

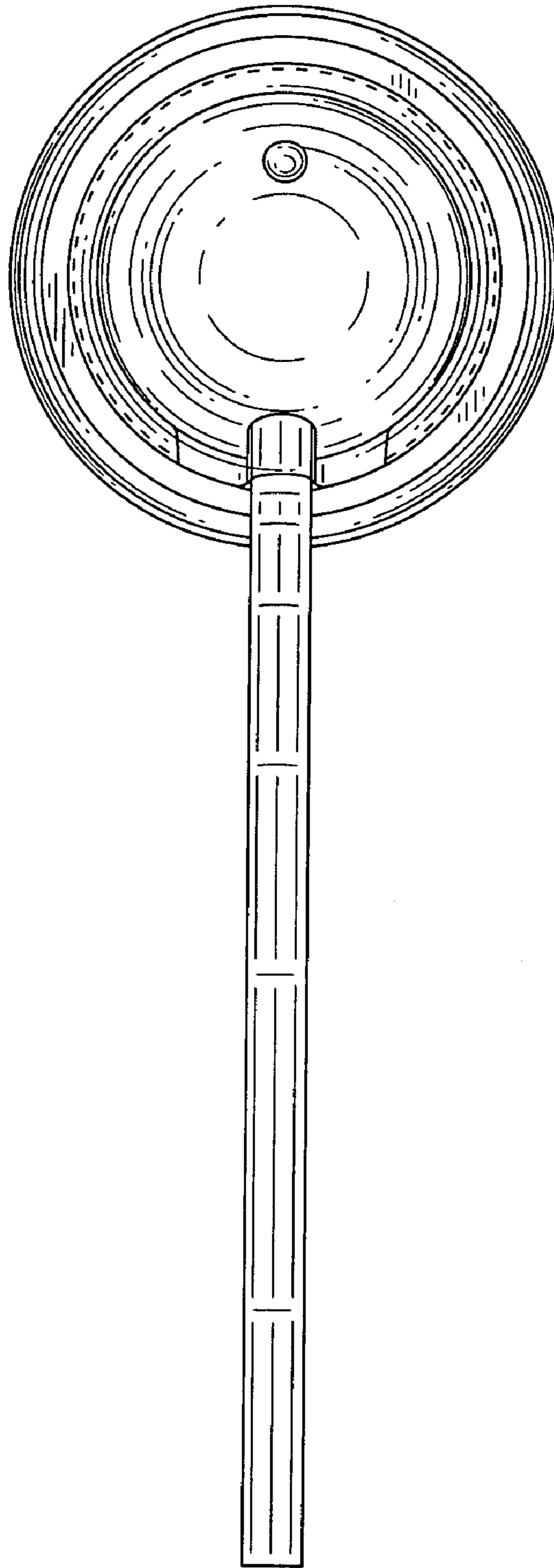

FIG.5

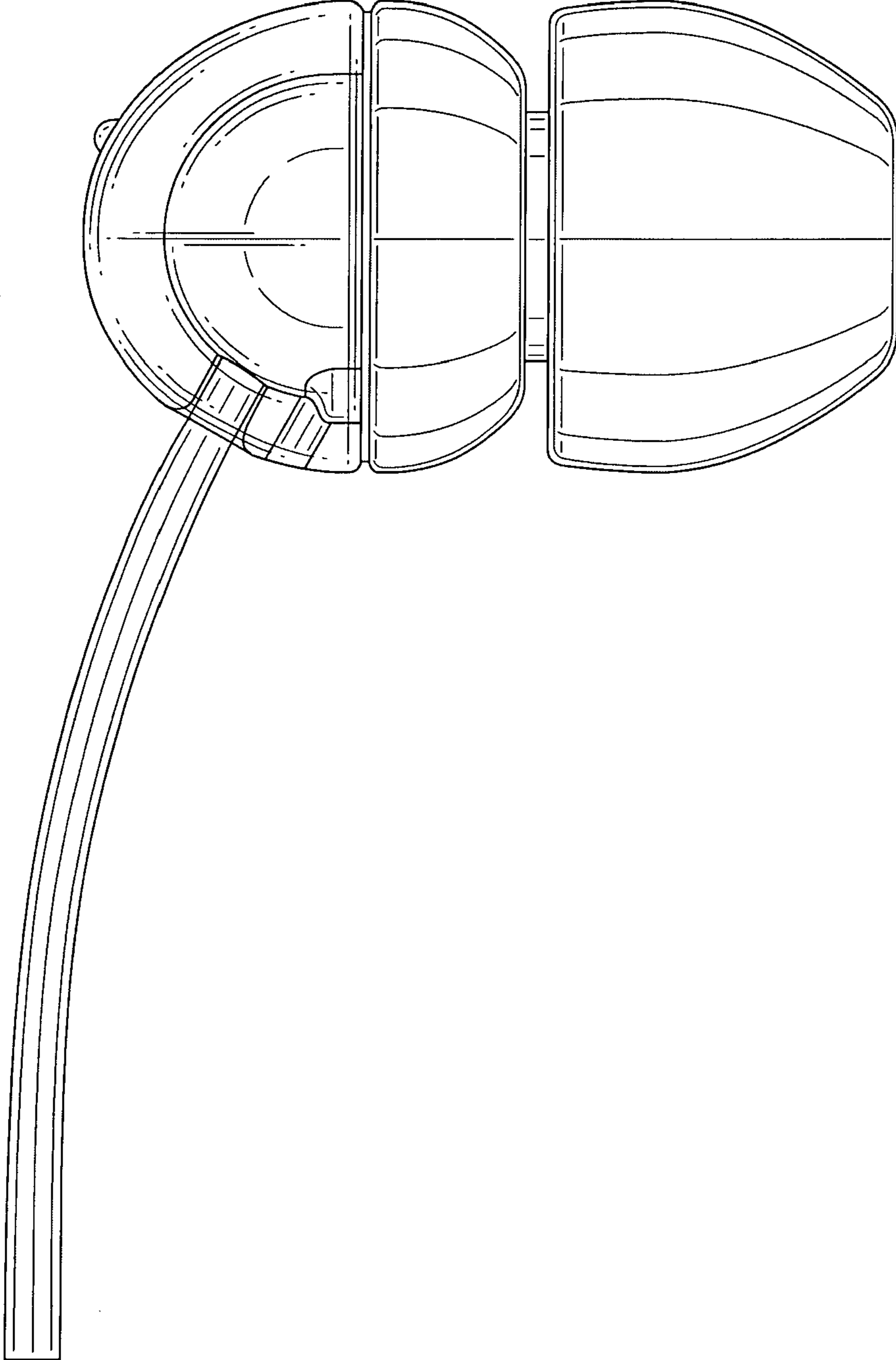

FIG.6

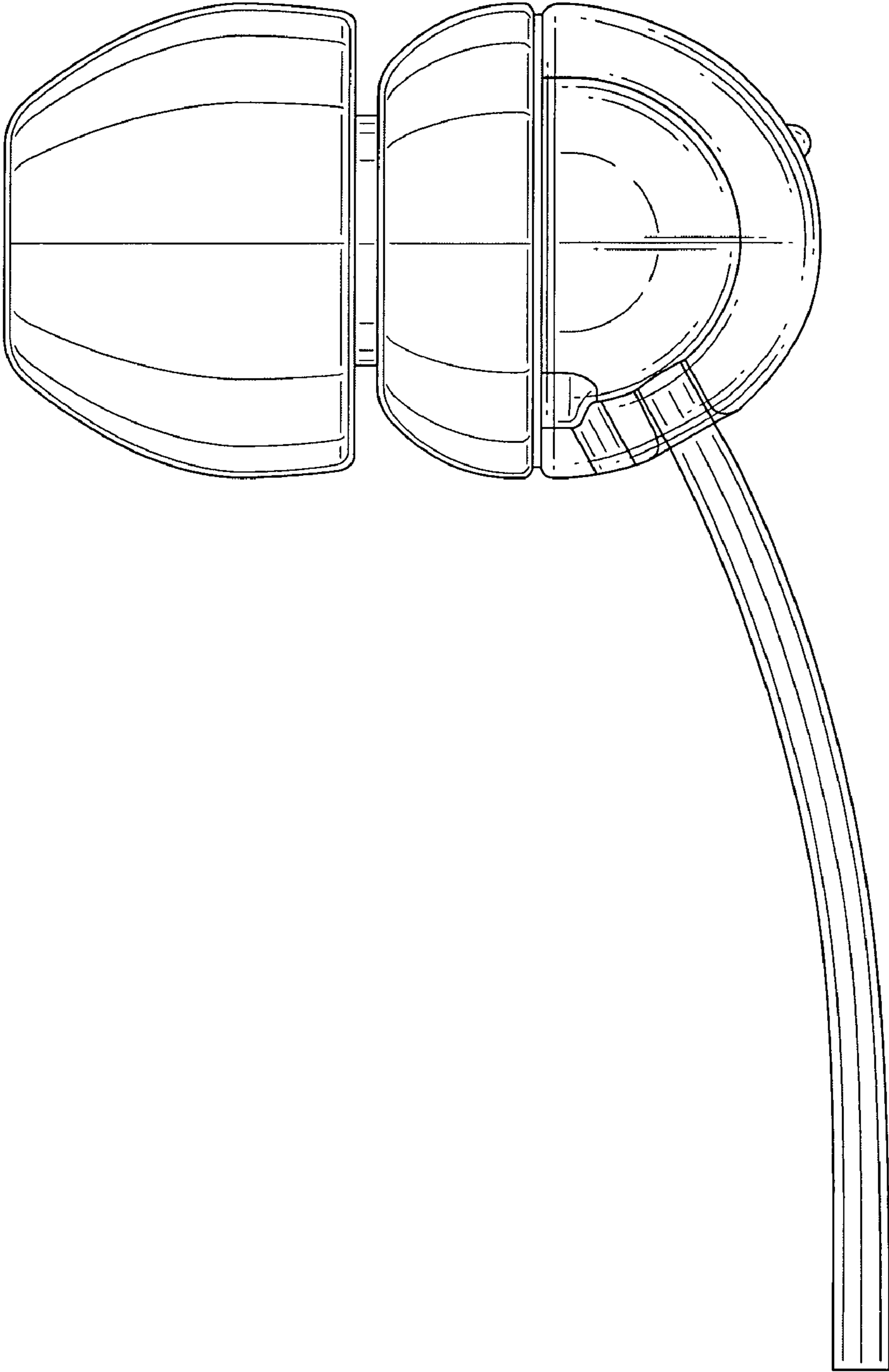

FIG.7

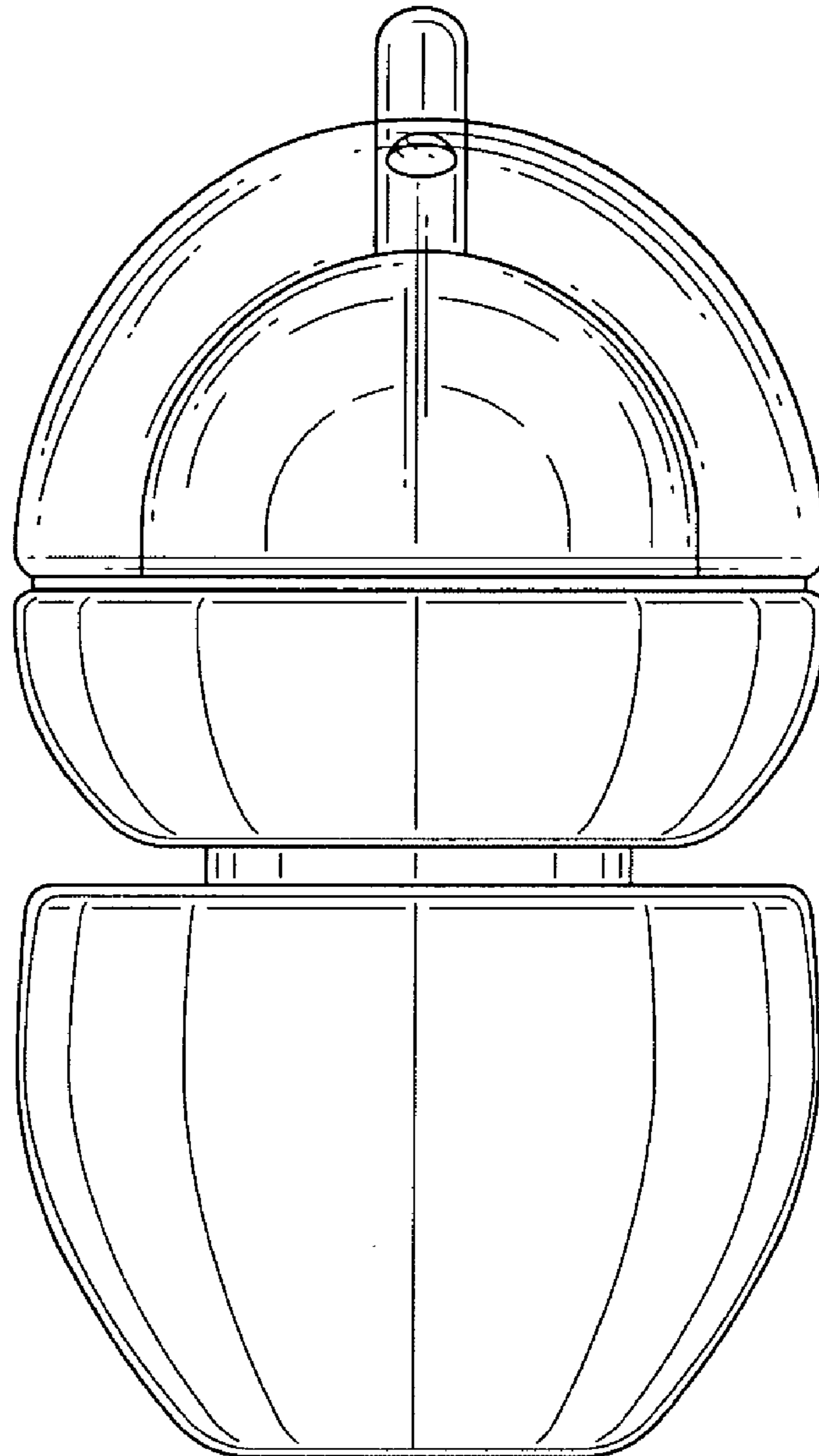

FIG.8

