



US00D602712S

(12) **United States Design Patent**
Ho

(10) **Patent No.:** **US D602,712 S**
(45) **Date of Patent:** **** Oct. 27, 2009**

(54) **MODULAR UTILITY RACK**

(75) Inventor: **Edwin Ho**, Irvine, CA (US)

(73) Assignee: **Seville Classics, Inc.**, Torrance, CA (US)

(**) Term: **14 Years**

(21) Appl. No.: **29/312,973**

(22) Filed: **Nov. 26, 2008**

(51) **LOC (9) Cl.** **06-04**

(52) **U.S. Cl.** **D6/465**

(58) **Field of Classification Search** D6/465,
D6/409-415, 449, 455-458, 461-464, 466-468,
D6/474, 476, 499, 405; 211/31.1, 85.26,
211/85.31, 85.4, 33, 134, 186-88, 189-191,
211/194, 181.1, 153; D34/12; 108/107
See application file for complete search history.

(56) **References Cited**

U.S. PATENT DOCUMENTS

D215,773	S *	10/1969	Maslow	D6/462
4,637,323	A *	1/1987	Nicely	108/107
D291,165	S *	8/1987	Ray	D6/465
D292,658	S *	11/1987	Kester	D6/465
D292,764	S *	11/1987	Kester	D6/465
4,895,382	A	1/1990	Andersson		
4,978,013	A	12/1990	Hogg		
D323,256	S *	1/1992	Kee	D6/465
D328,400	S *	8/1992	Kee	D6/465
D329,556	S *	9/1992	Brussing	D6/468
5,676,263	A *	10/1997	Chang	211/187
D392,817	S	3/1998	Lee		
5,738,230	A	4/1998	Goldstein		
D393,970	S	5/1998	Lee		
5,779,070	A *	7/1998	Dickinson et al.	211/187
5,913,270	A	6/1999	Price		
D424,836	S *	5/2000	Kopala, Jr.	D6/465
D429,092	S *	8/2000	Walter	D6/465
D432,820	S *	10/2000	Walters-Dowding et al.	D6/465
6,302,284	B1 *	10/2001	Zonshin	211/187

6,443,410	B1	9/2002	Lee		
D471,033	S *	3/2003	Yamaguchi	D6/465
D471,381	S *	3/2003	Yamaguchi	D6/465
D474,870	S *	5/2003	Post et al.	D34/12
6,561,107	B1	5/2003	Wood et al.		
6,899,237	B2	5/2005	Trent		
D506,625	S *	6/2005	Yamaguchi	D6/499
D538,058	S *	3/2007	Van Es	D6/405
D540,568	S *	4/2007	Clucas	D6/465
2008/0308516	A1 *	12/2008	Li	211/153

* cited by examiner

Primary Examiner—Caron Veynar

Assistant Examiner—Sydney R Buffalow

(74) *Attorney, Agent, or Firm*—Raymond Sun

(57) **CLAIM**

The ornamental design for a modular utility rack, as shown.

DESCRIPTION

FIG. 1 is a perspective view of a modular utility rack showing my new design.

FIG. 2 is a front plan view thereof;

FIG. 3 is a left plan view thereof;

FIG. 4 is a right plan view thereof;

FIG. 5 is a top plan view thereof;

FIG. 6 is a bottom view thereof;

FIG. 7 is a back view thereof;

FIG. 8 is a perspective view of a second embodiment of a modular utility rack thereof;

FIG. 9 is a front plan view thereof;

FIG. 10 is a left plan view thereof;

FIG. 11 is a right plan view thereof;

FIG. 12 is a top plan view thereof;

FIG. 13 is a bottom view thereof; and,

FIG. 14 is a back plan view.

1 Claim, 14 Drawing Sheets

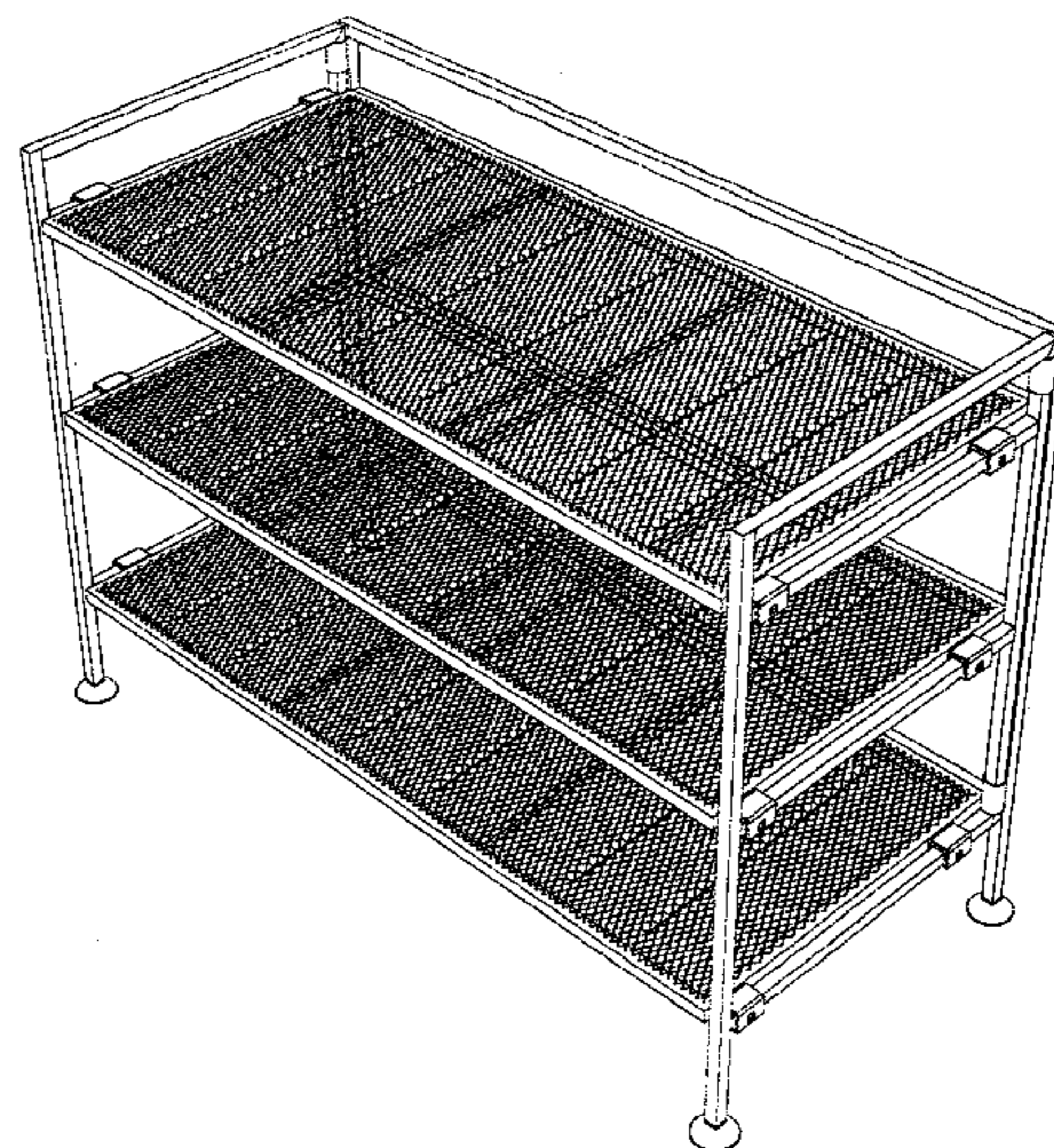
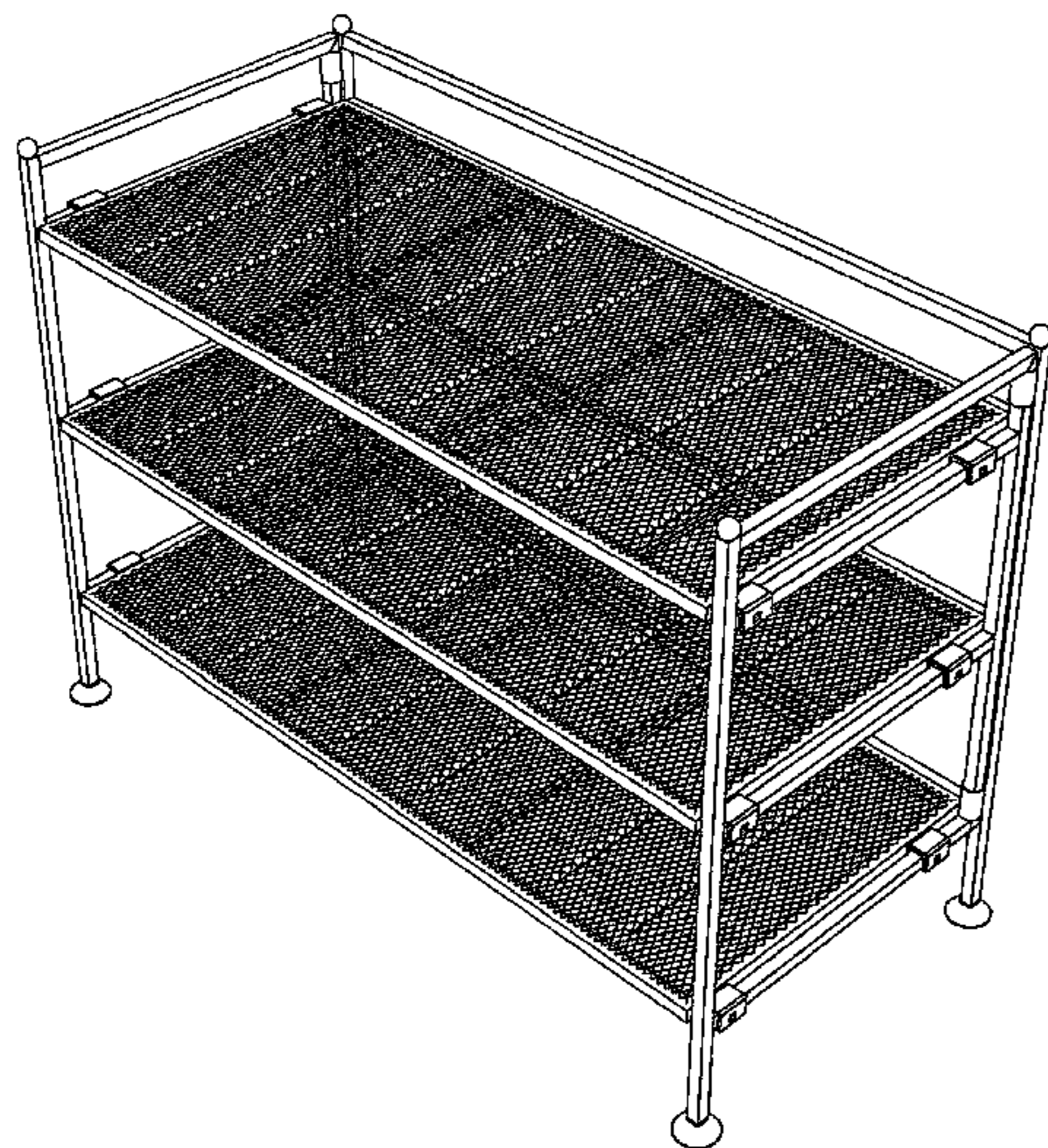

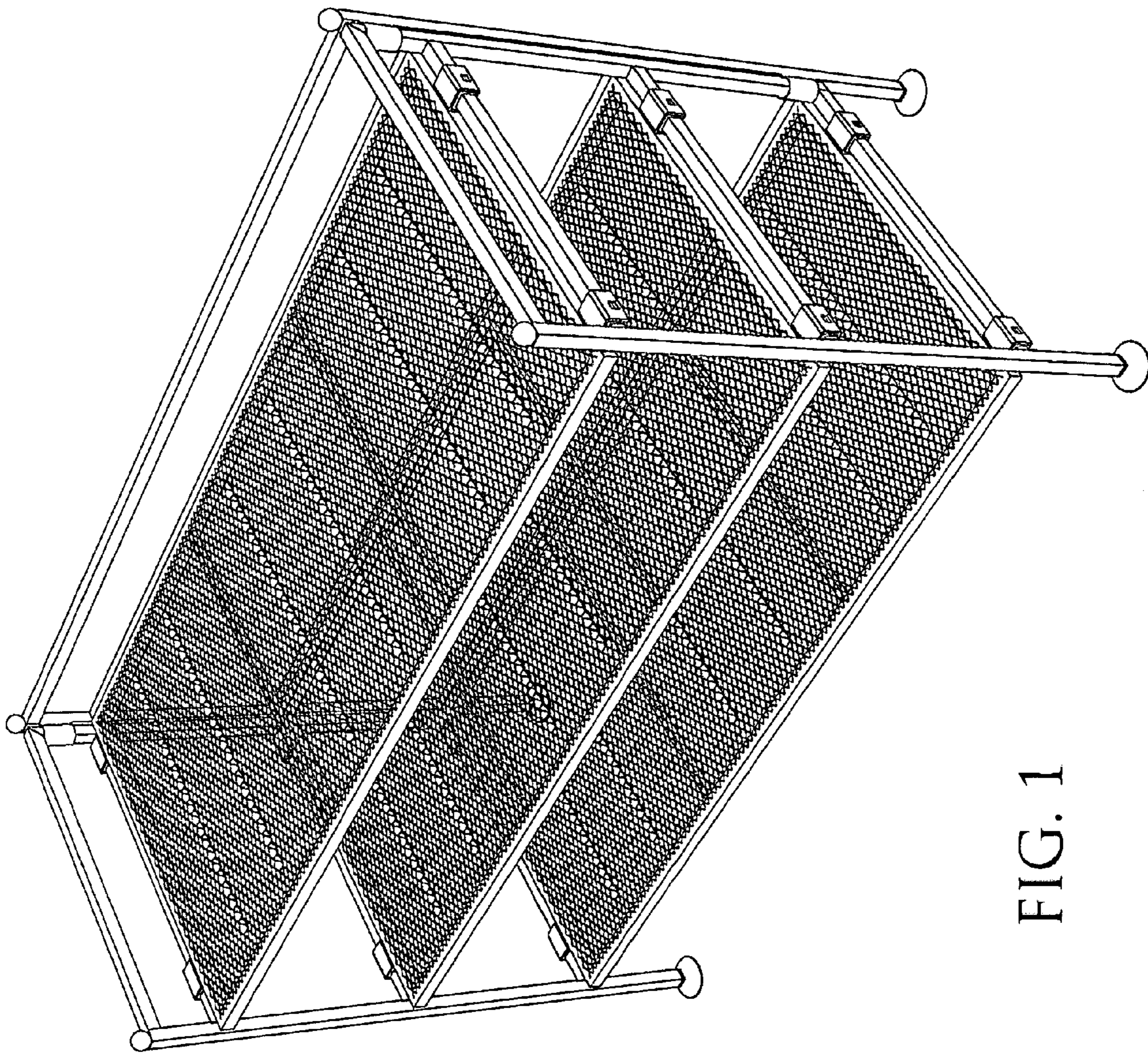

FIG. 1

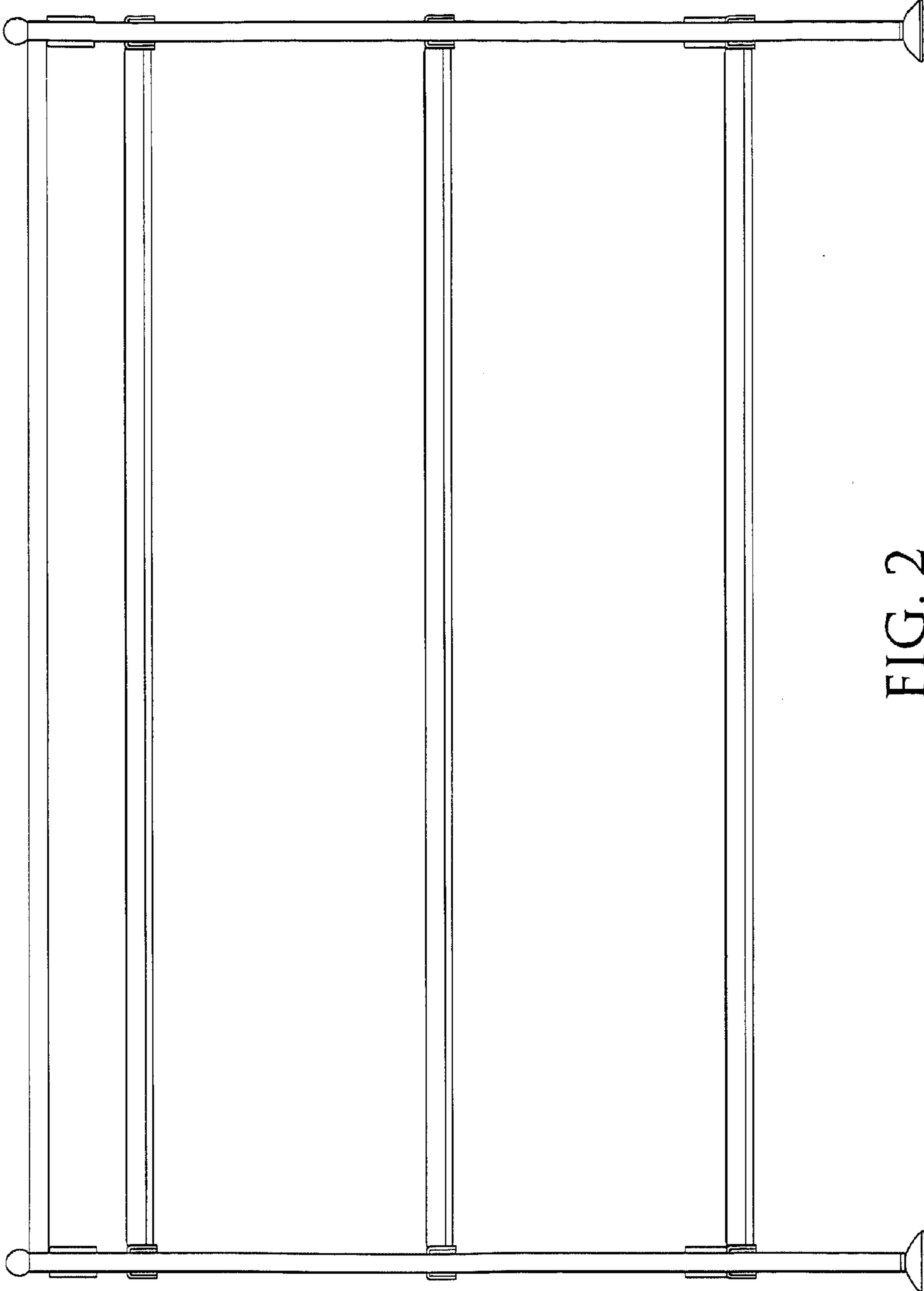

FIG. 2

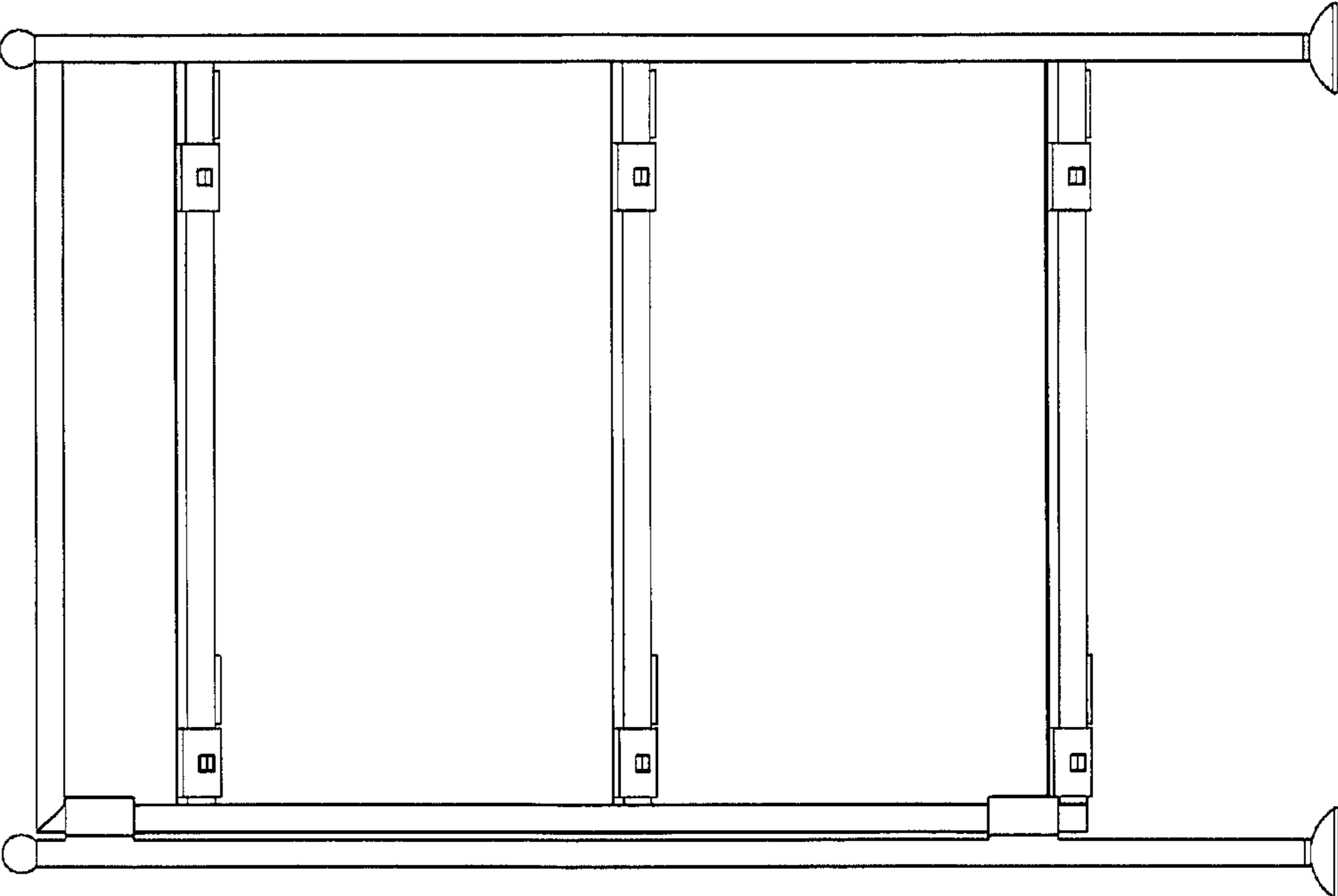

FIG. 3

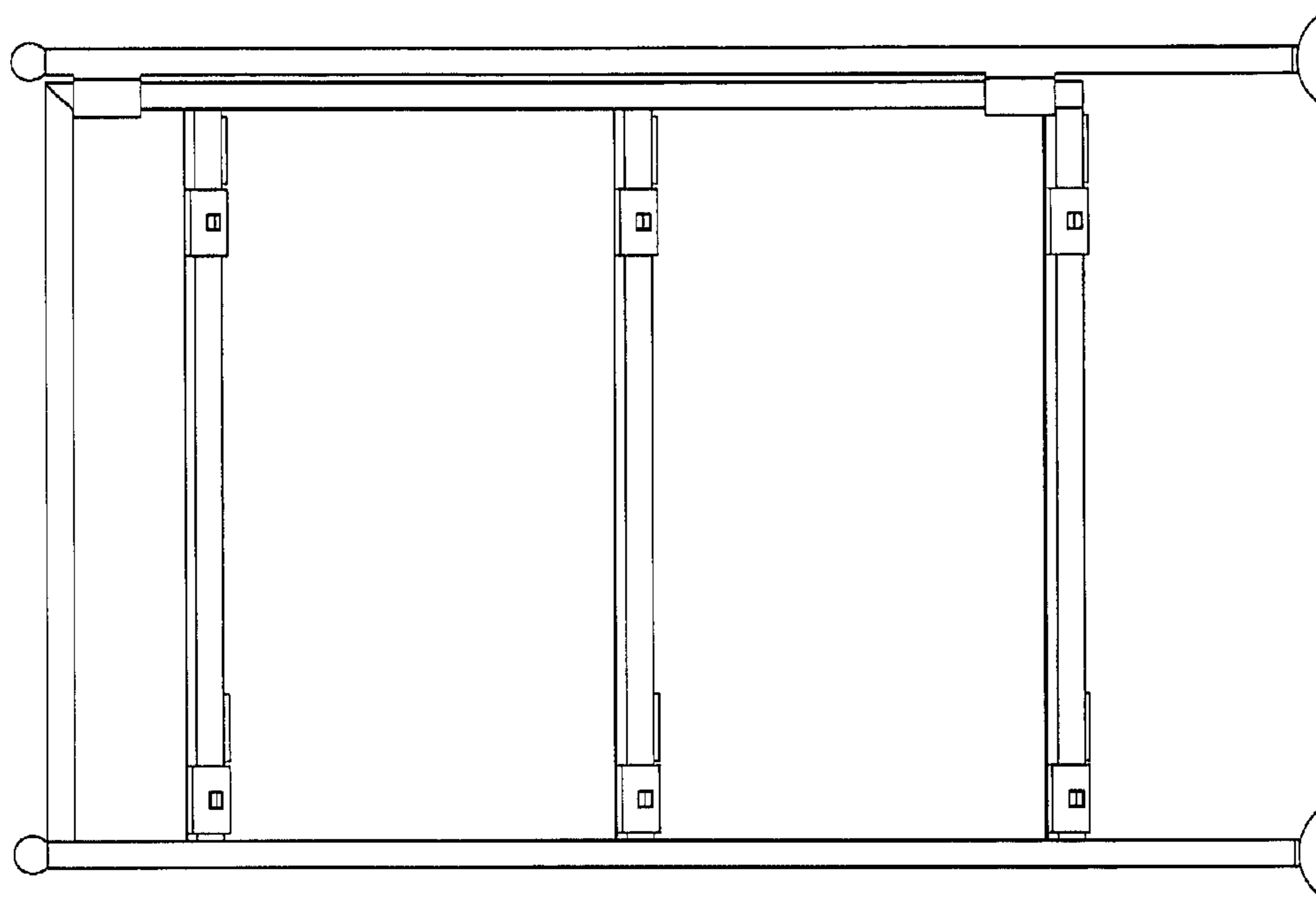

FIG. 4

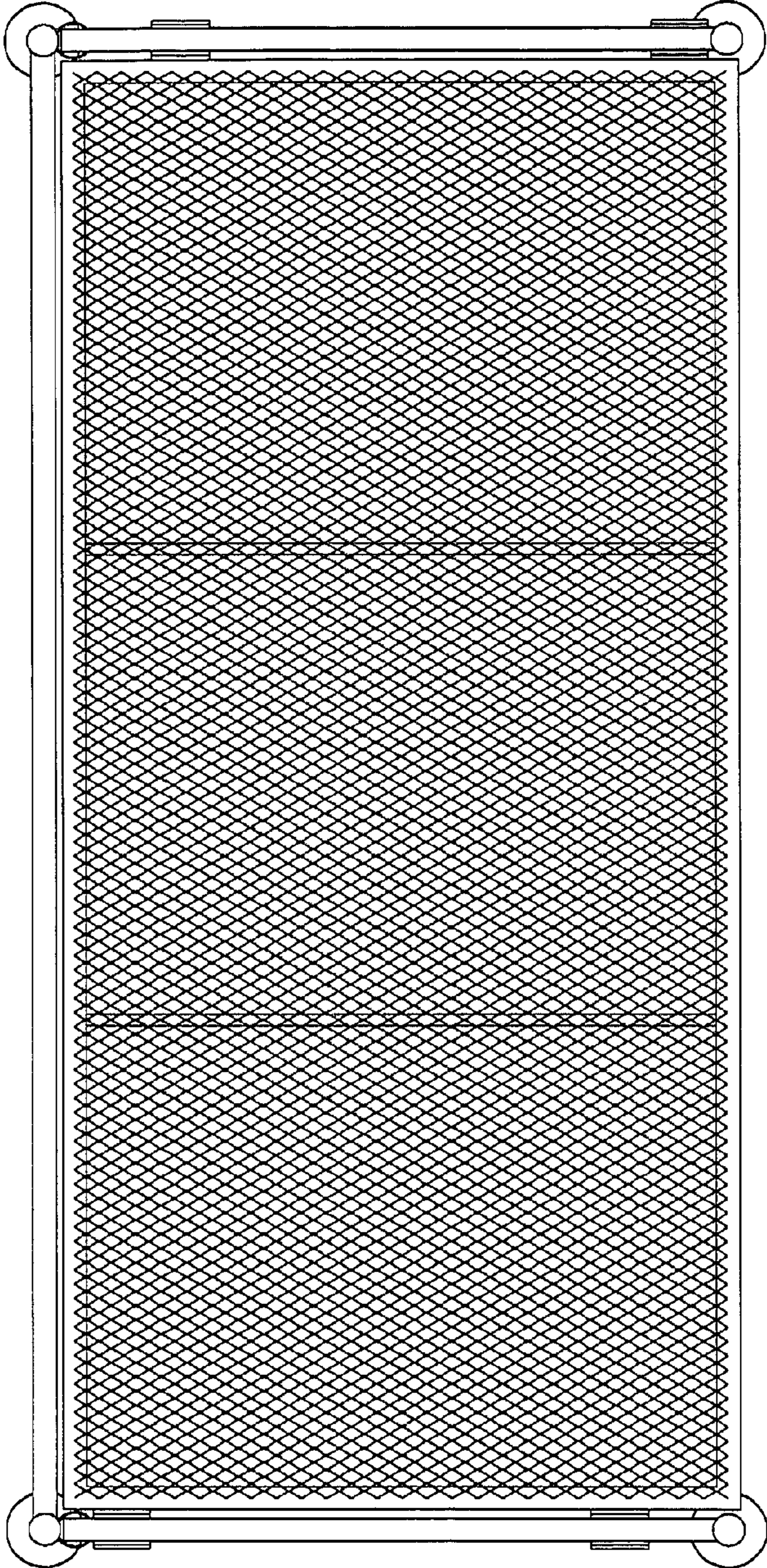

FIG. 5

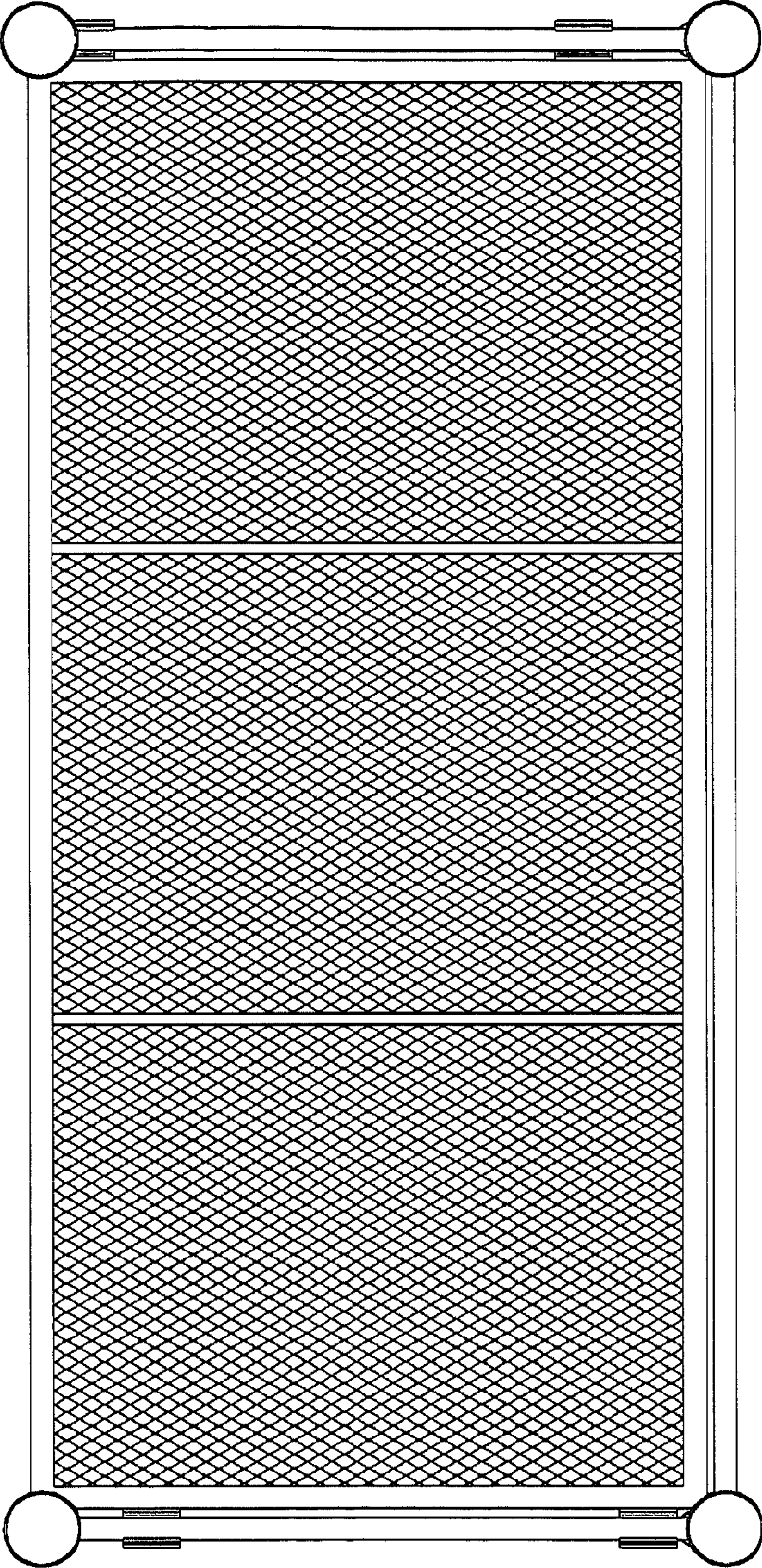

FIG. 6

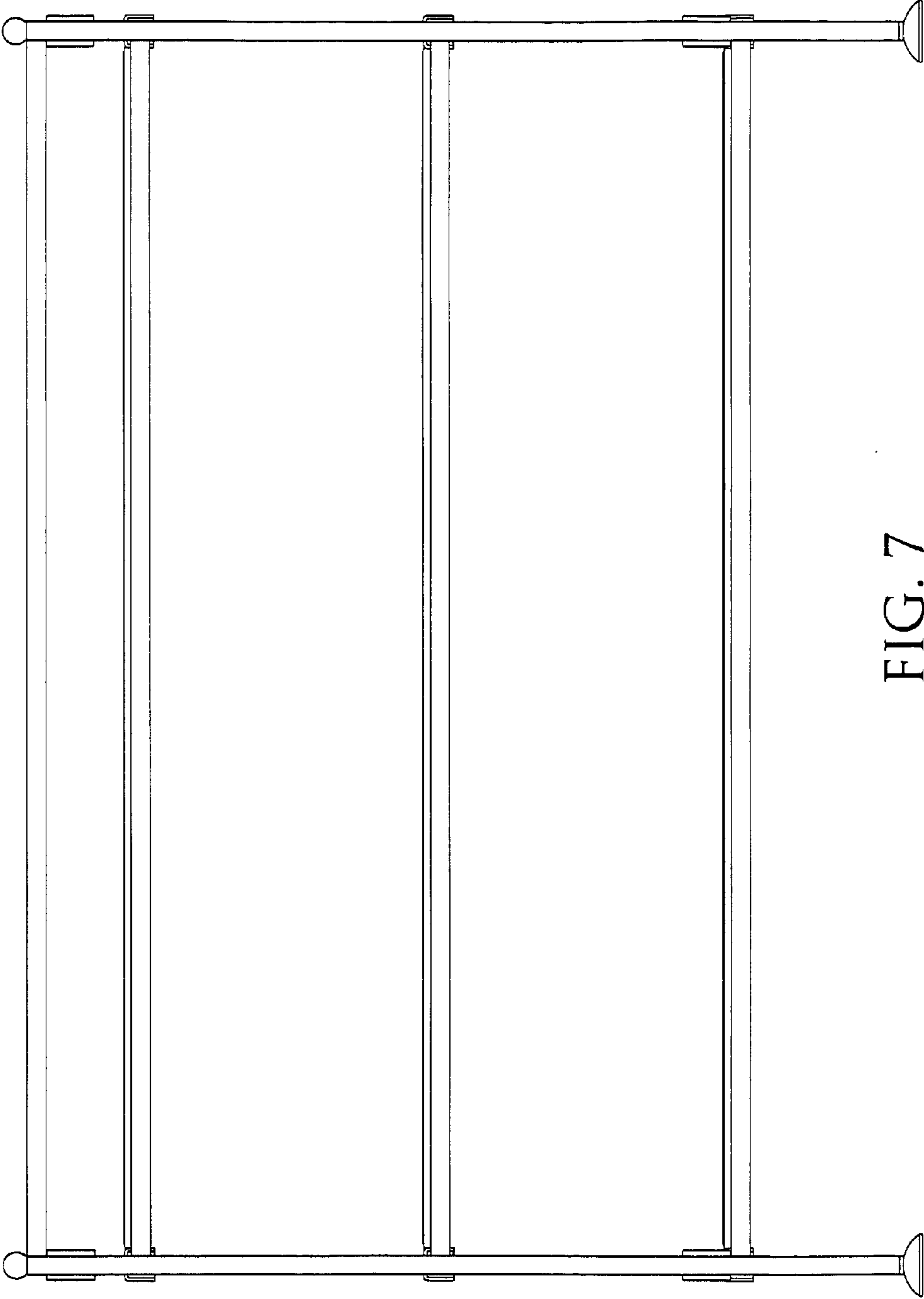

FIG. 7

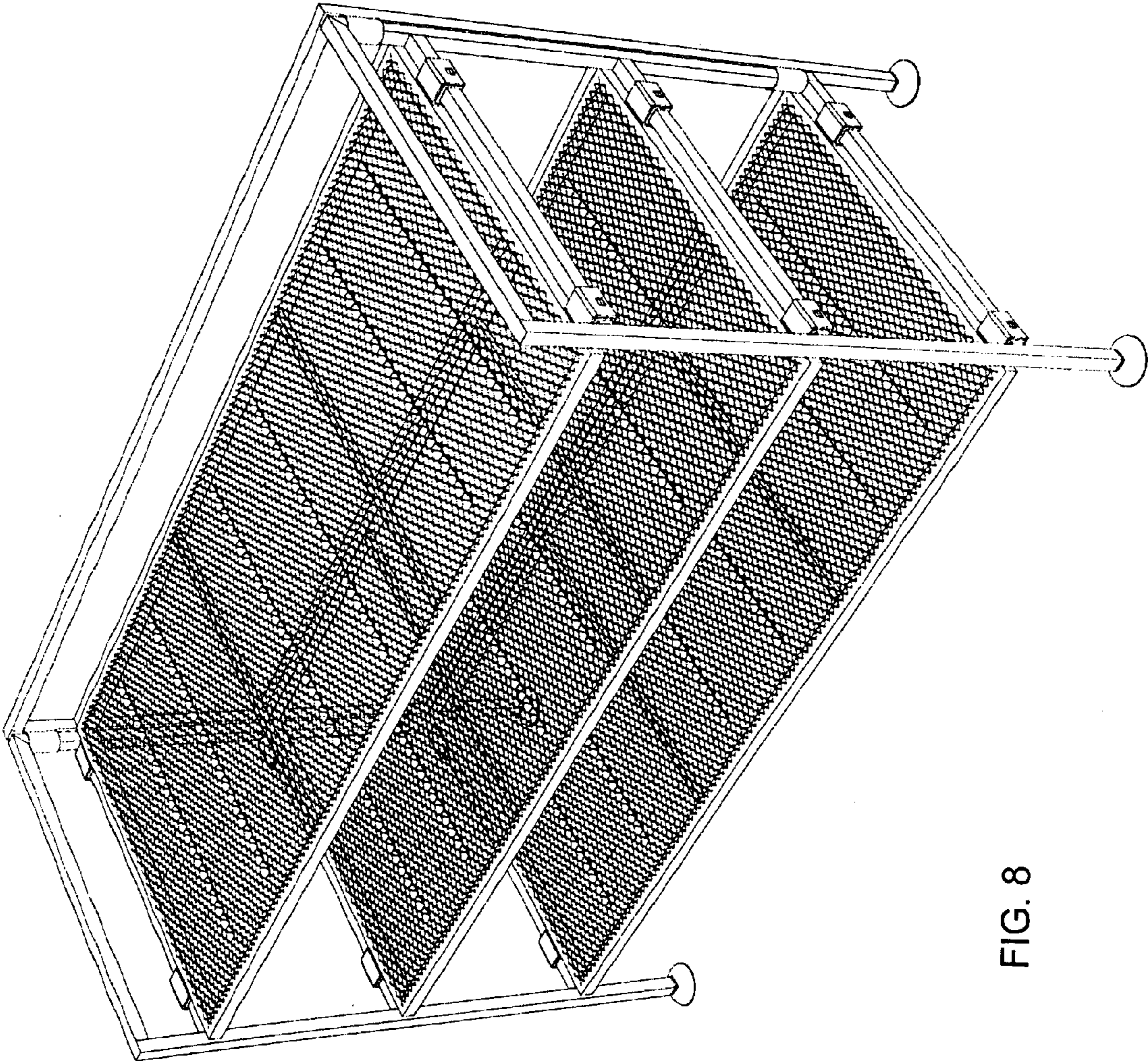

FIG. 8

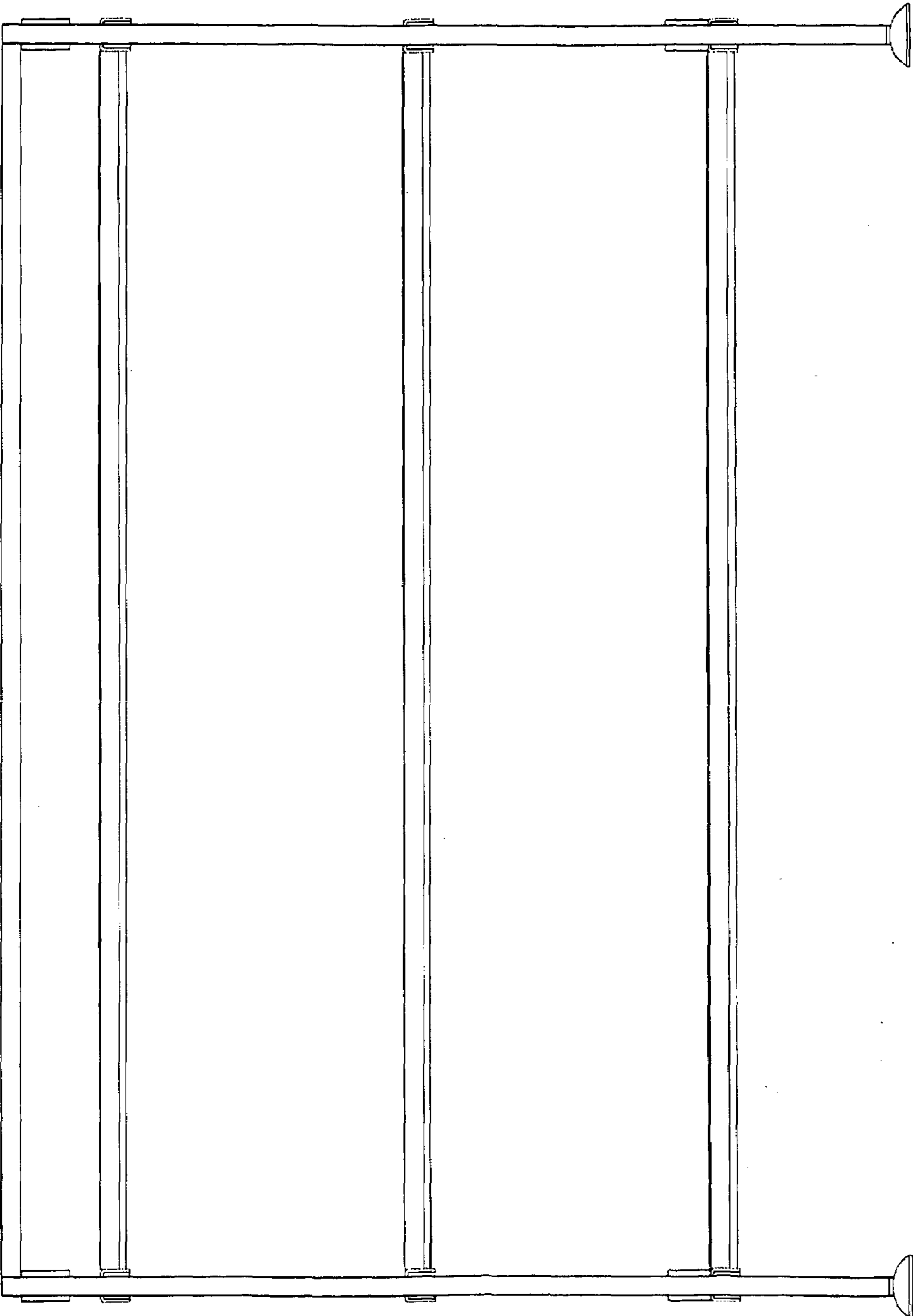

FIG. 9

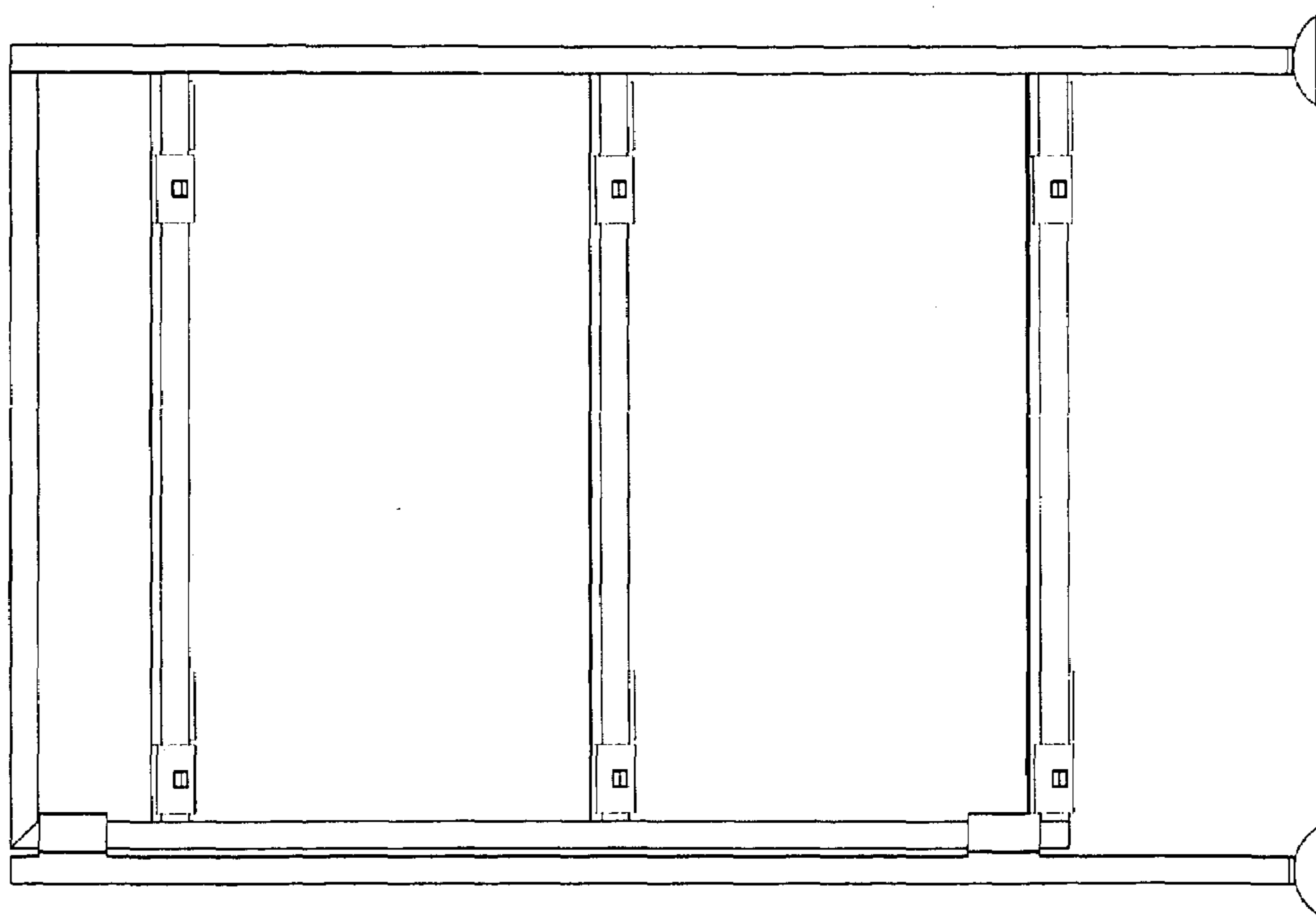

FIG. 10

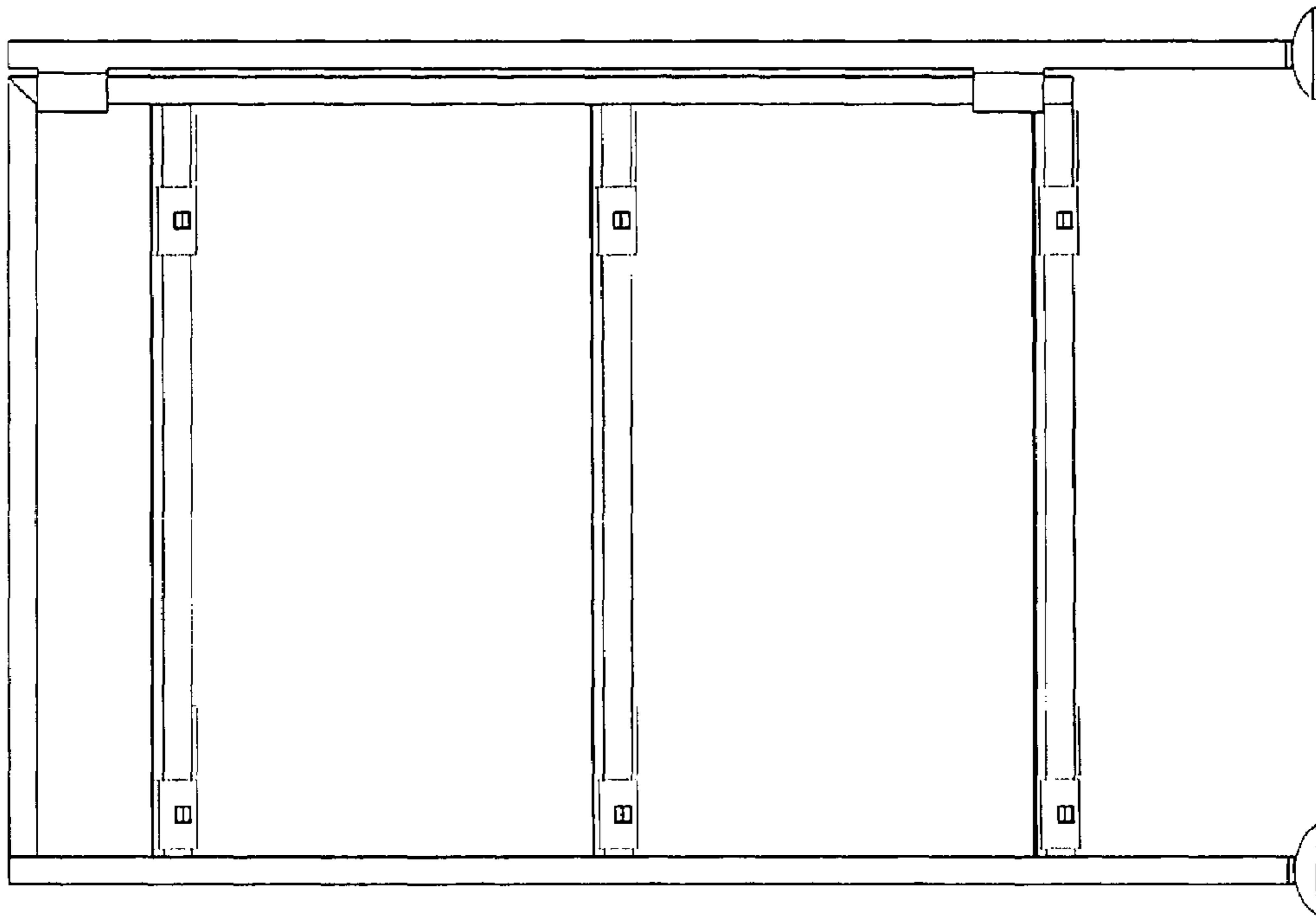

FIG. 11

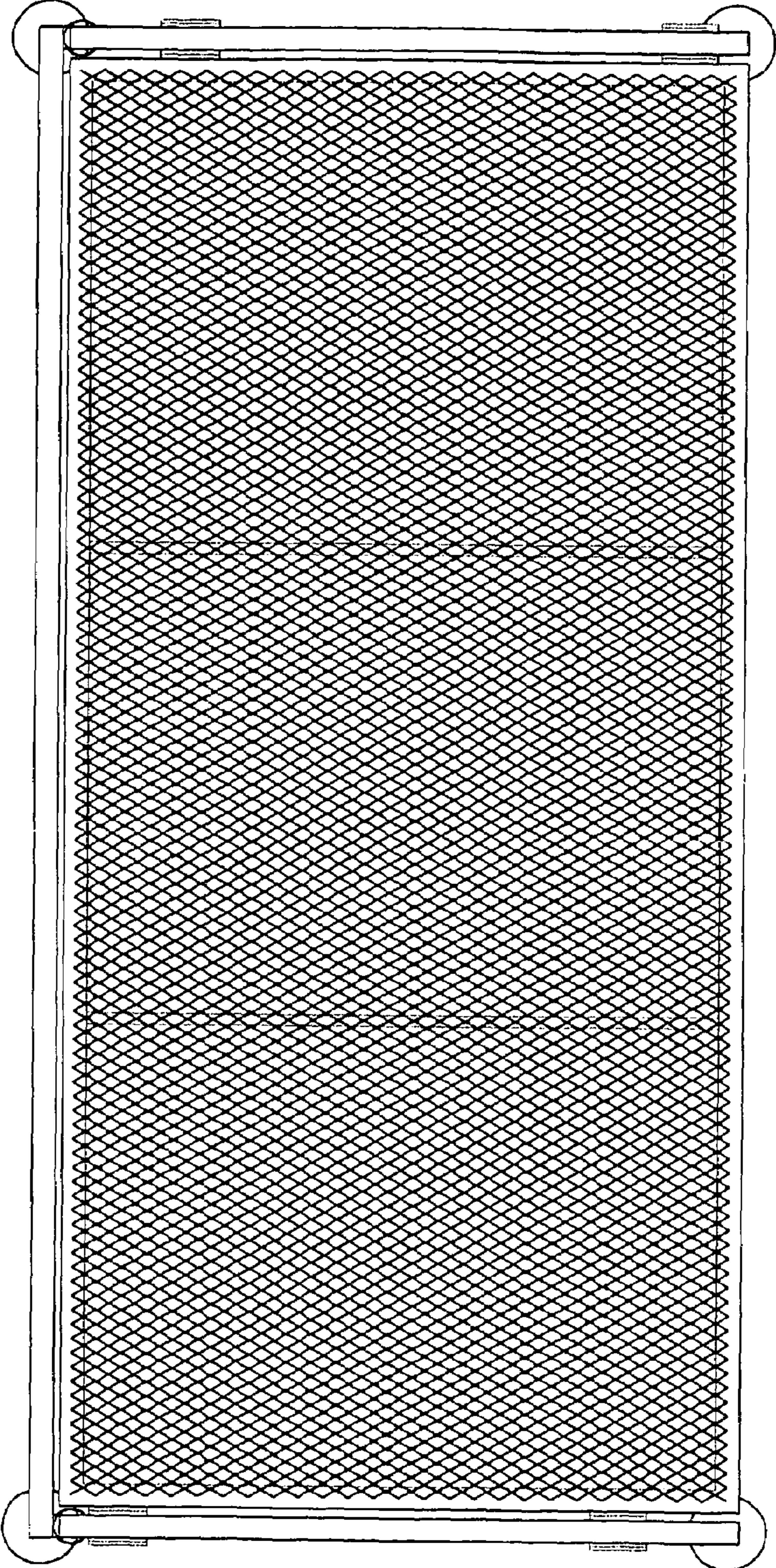

FIG. 12

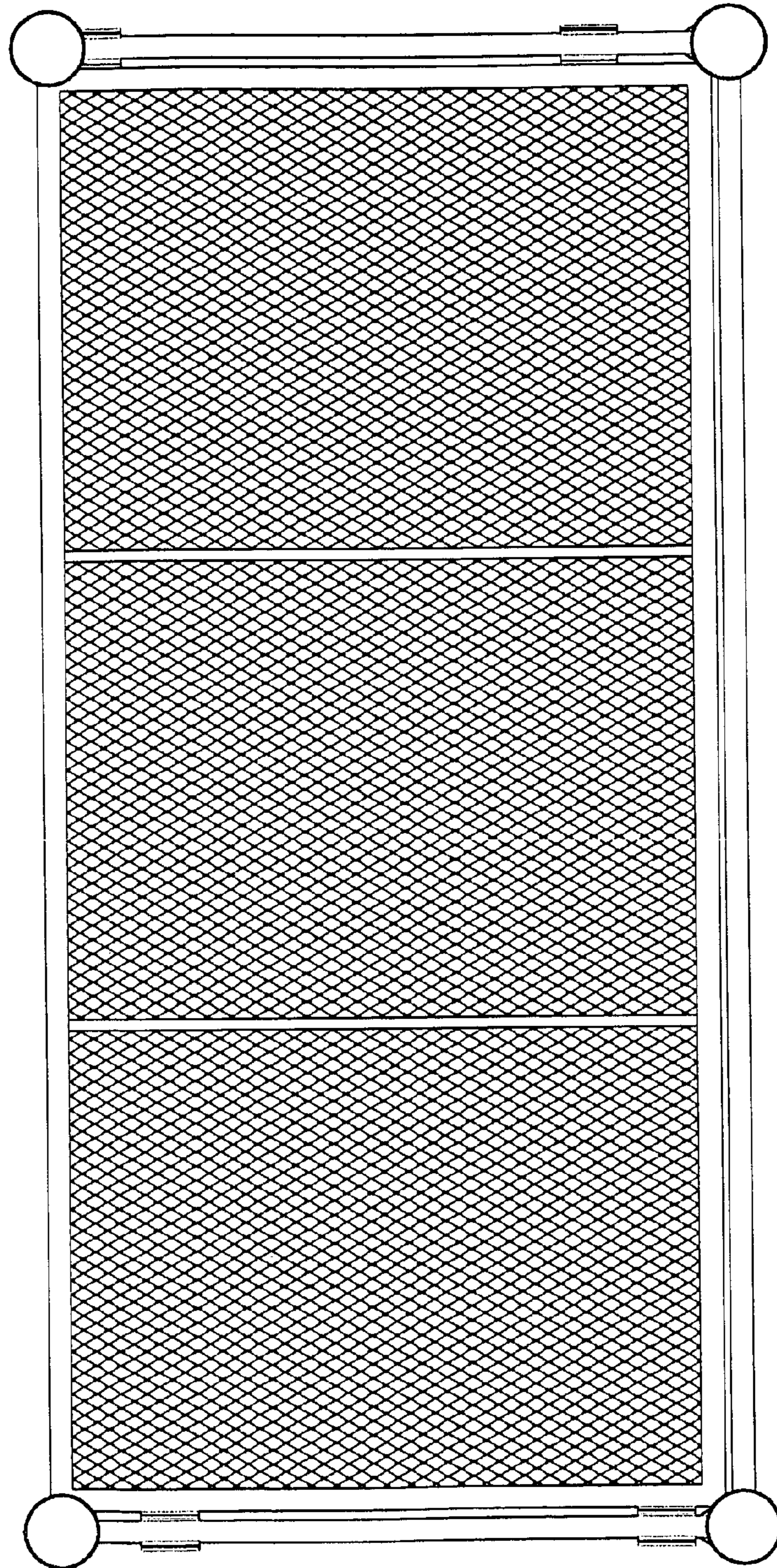

FIG. 13



FIG. 14