



US00D602661S

(12) **United States Design Patent**  
**Griffin et al.**

(10) **Patent No.:** **US D602,661 S**

(45) **Date of Patent:** **\*\* Oct. 20, 2009**

(54) **VACUUM CLEANER**

(75) Inventors: **John Griffin**, Phoenix, AZ (US); **Robert L. Crevling, Jr.**, Williamsport, PA (US); **Liu H. Li**, South Williamsport, PA (US)

(73) Assignee: **Shop-Vac Corporation**, Williamsport, PA (US)

(\*\*) Term: **14 Years**

(21) Appl. No.: **29/279,948**

(22) Filed: **May 11, 2007**

(51) **LOC (9) Cl.** ..... **15-05**

(52) **U.S. Cl.** ..... **D32/31**

(58) **Field of Classification Search** ..... D32/21,  
D32/23-24, 31, 15-16; D23/225; 15/320-321,  
15/353, 323, 327.1-327.7, 329, 339, 412,  
15/340.2, 344, 347; 55/DIG. 2  
See application file for complete search history.

(56) **References Cited**

**U.S. PATENT DOCUMENTS**

- D264,087 S \* 4/1982 Bennett ..... D32/23
- D286,336 S \* 10/1986 Berfield et al. .... D32/23
- D367,342 S 2/1996 Langeland et al.
- D389,962 S \* 1/1998 Berfield et al. .... D32/23
- D429,042 S 8/2000 Griffin et al.
- D445,549 S 7/2001 Griffin
- D447,293 S 8/2001 Griffin
- D469,934 S 2/2003 Fry et al.
- D470,280 S \* 2/2003 Griffin et al. .... D32/23
- D506,042 S 6/2005 Griffin et al.
- D507,686 S \* 7/2005 Krieger et al. .... D32/23

- D527,503 S \* 8/2006 Griffin et al. .... D32/21
- D528,256 S \* 9/2006 Beth et al. .... D32/21

**OTHER PUBLICATIONS**

- U.S. Appl. No. 29/279,946, Griffin et al., filed May 11, 2007.
- U.S. Appl. No. 29/279,957, Griffin et al., filed May 11, 2007.
- Shop-Vac Brochure, Ultra Plus and Ultra Pro, dated 2006.
- Karcher Catalogue, High Performance Wet and Dry Vacuums, Dust Extraction and Spray Extraction Machines, dated 1999.

\* cited by examiner

*Primary Examiner*—Ruth McInroy

(74) *Attorney, Agent, or Firm*—Marshall, Gerstein & Borum LLP

(57) **CLAIM**

We claim the ornamental design for a vacuum cleaner, and shown and described.

**DESCRIPTION**

FIG. 1 is a perspective view of a vacuum cleaner showing the new design.

FIG. 2 is a front view of the vacuum cleaner.

FIG. 3 is a rear view of the vacuum cleaner.

FIG. 4 is a right-side view of the vacuum cleaner.

FIG. 5 is a left-side view of the vacuum cleaner.

FIG. 6 is a top view of the vacuum cleaner.

The bottom of the vacuum cleaner forms no part of the claimed design.

The broken line showing of a head is for the purpose of illustrating the article and forms no part of the claimed design.

**1 Claim, 6 Drawing Sheets**

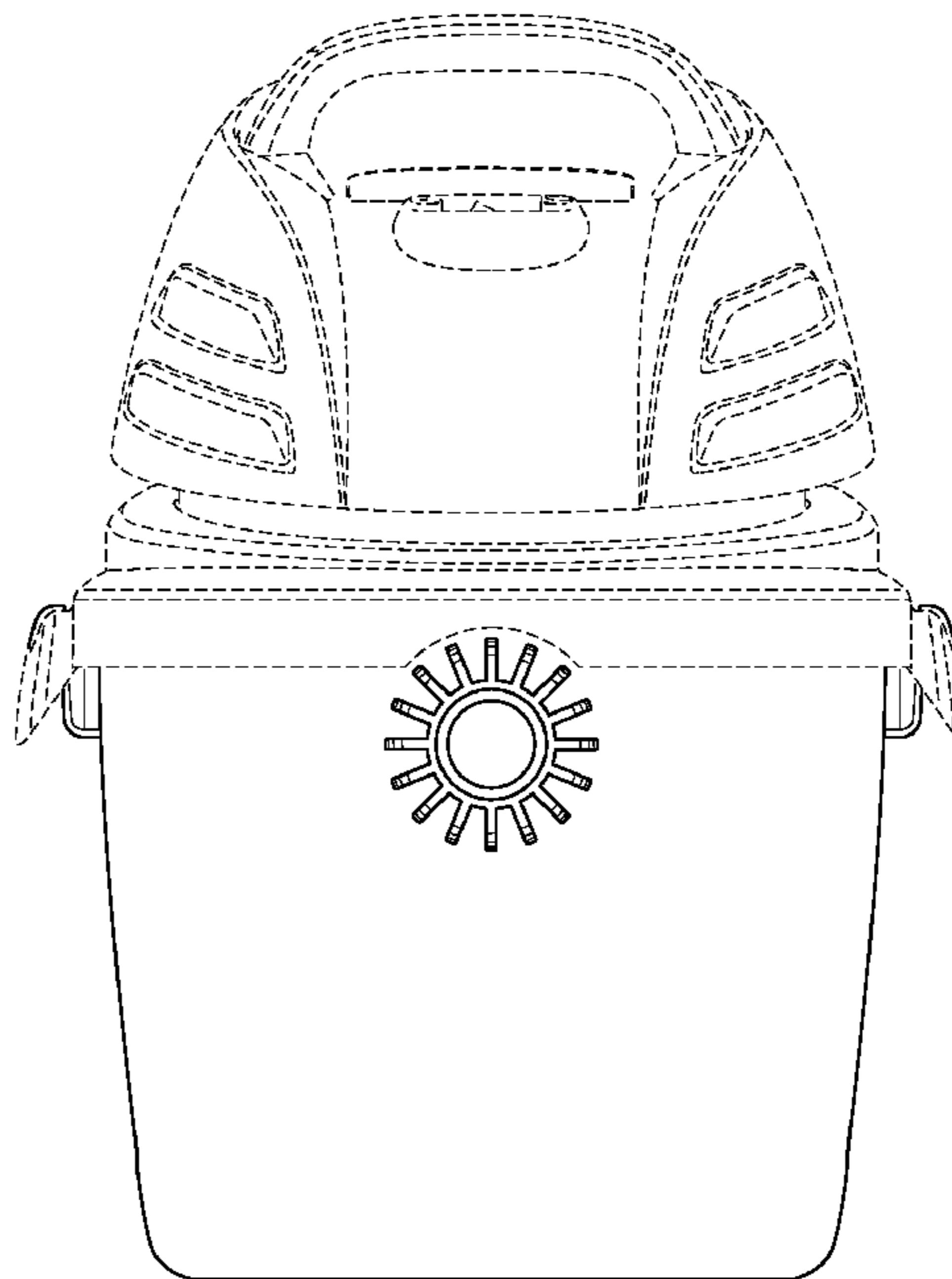
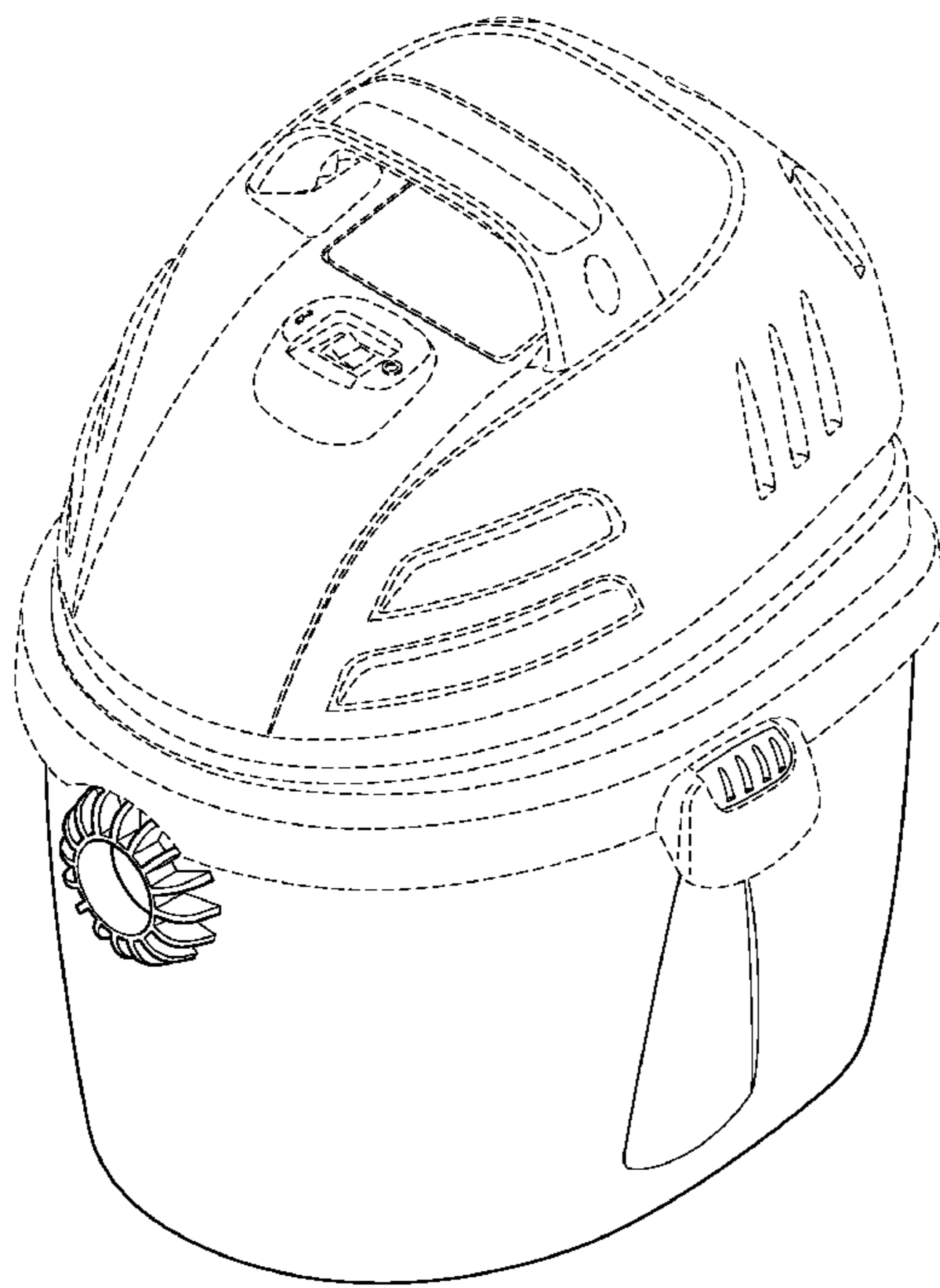

**FIG. 1**

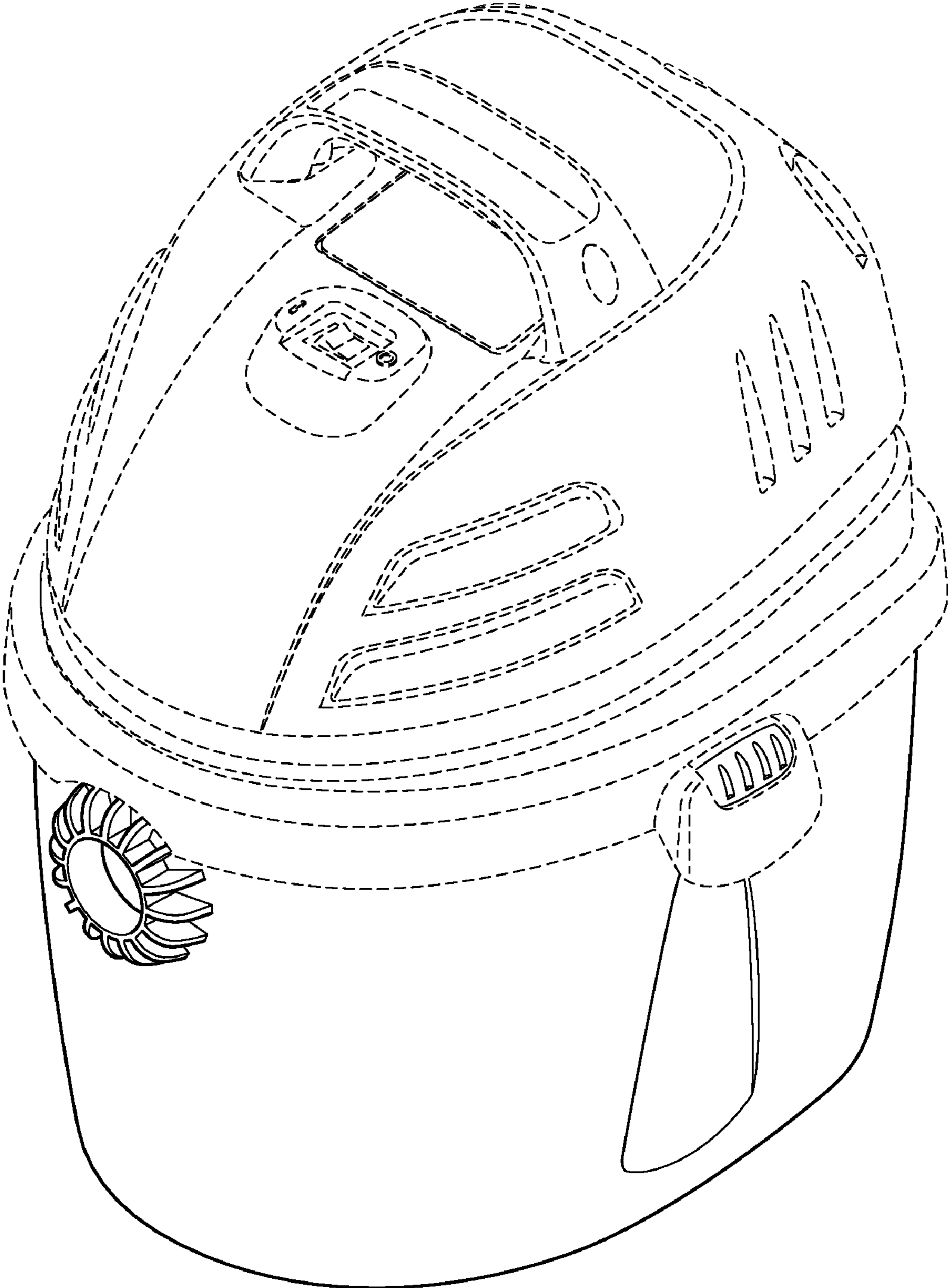

**FIG. 2**

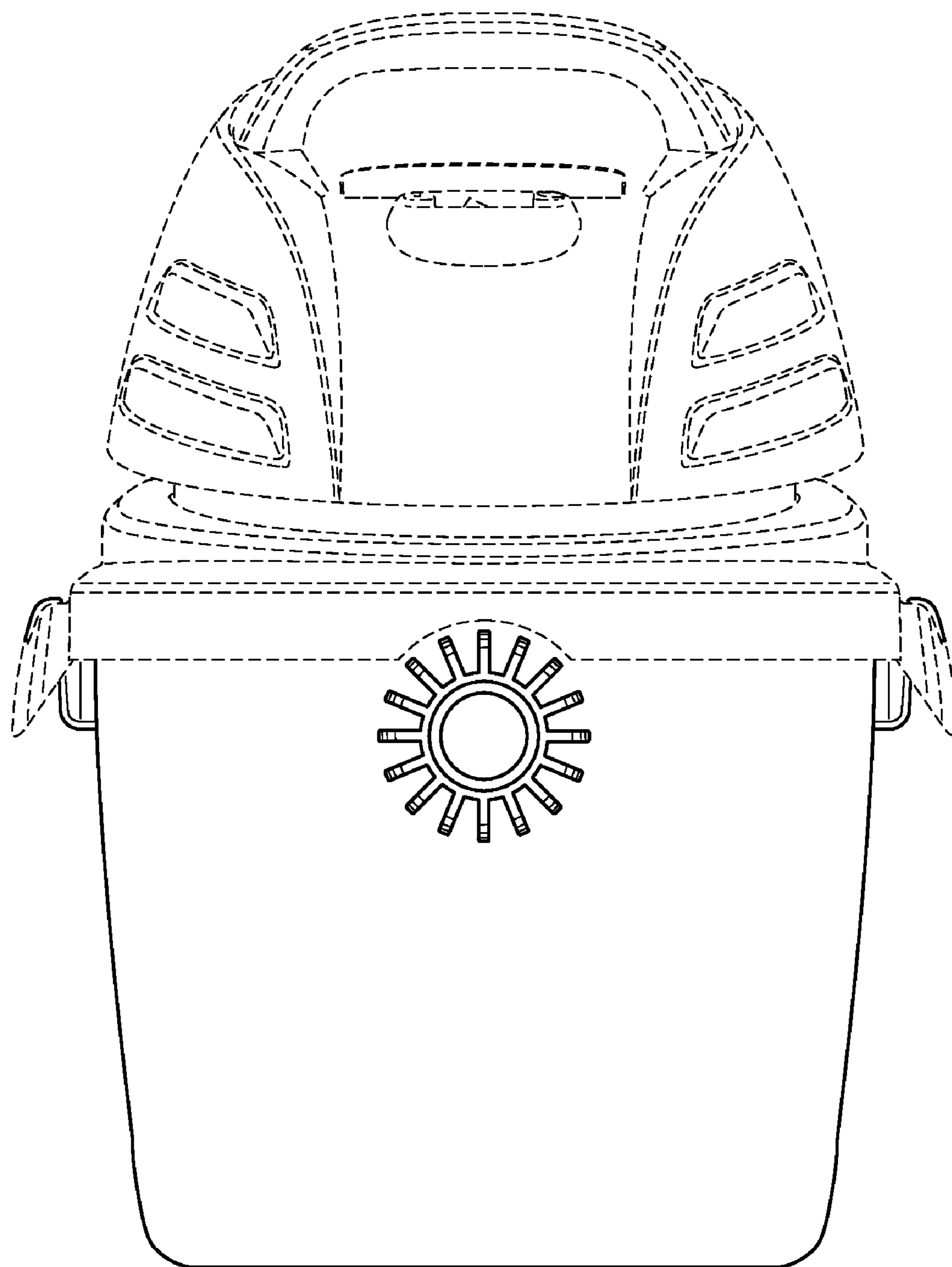

**FIG. 3**

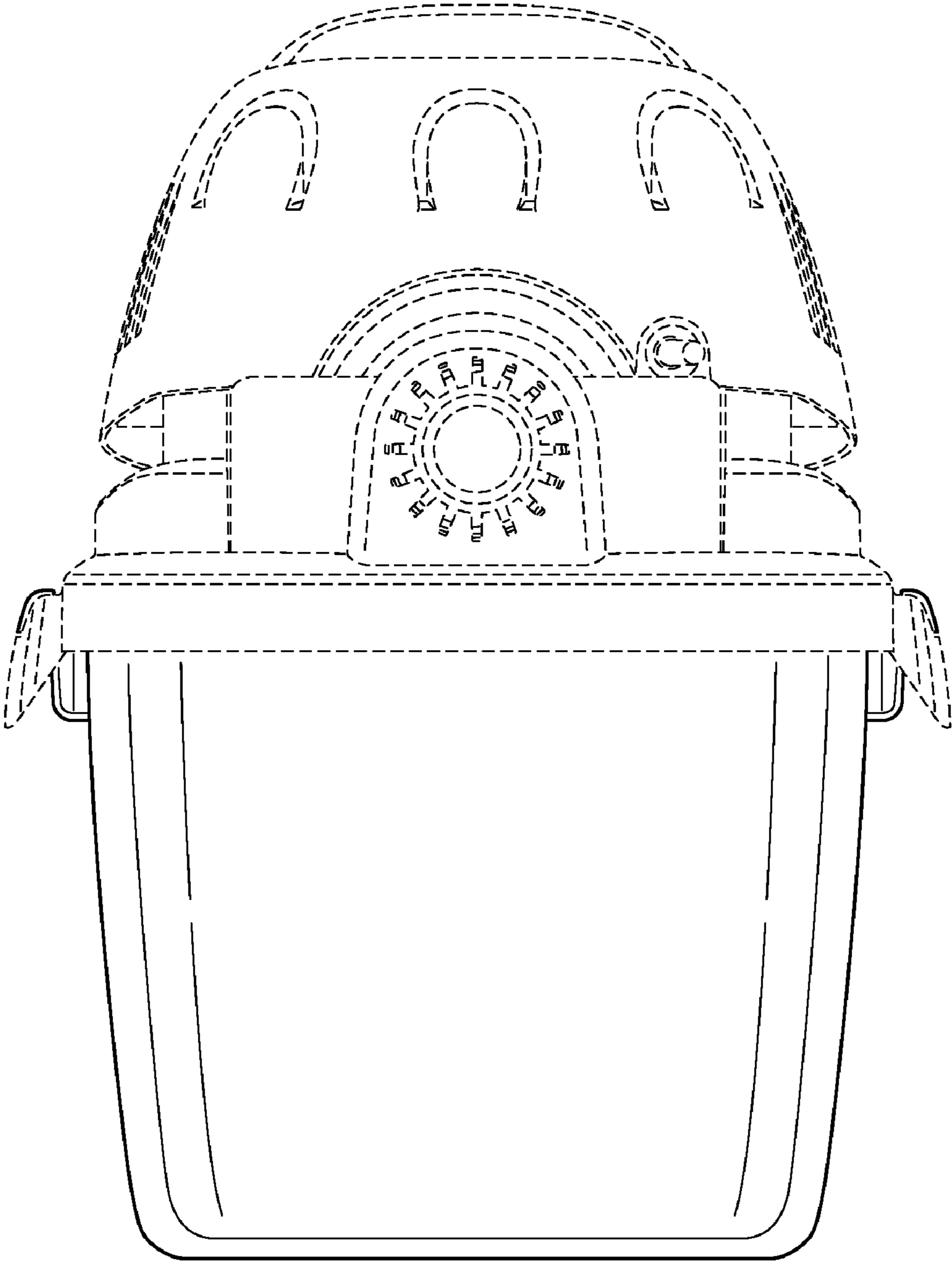

**FIG. 4**

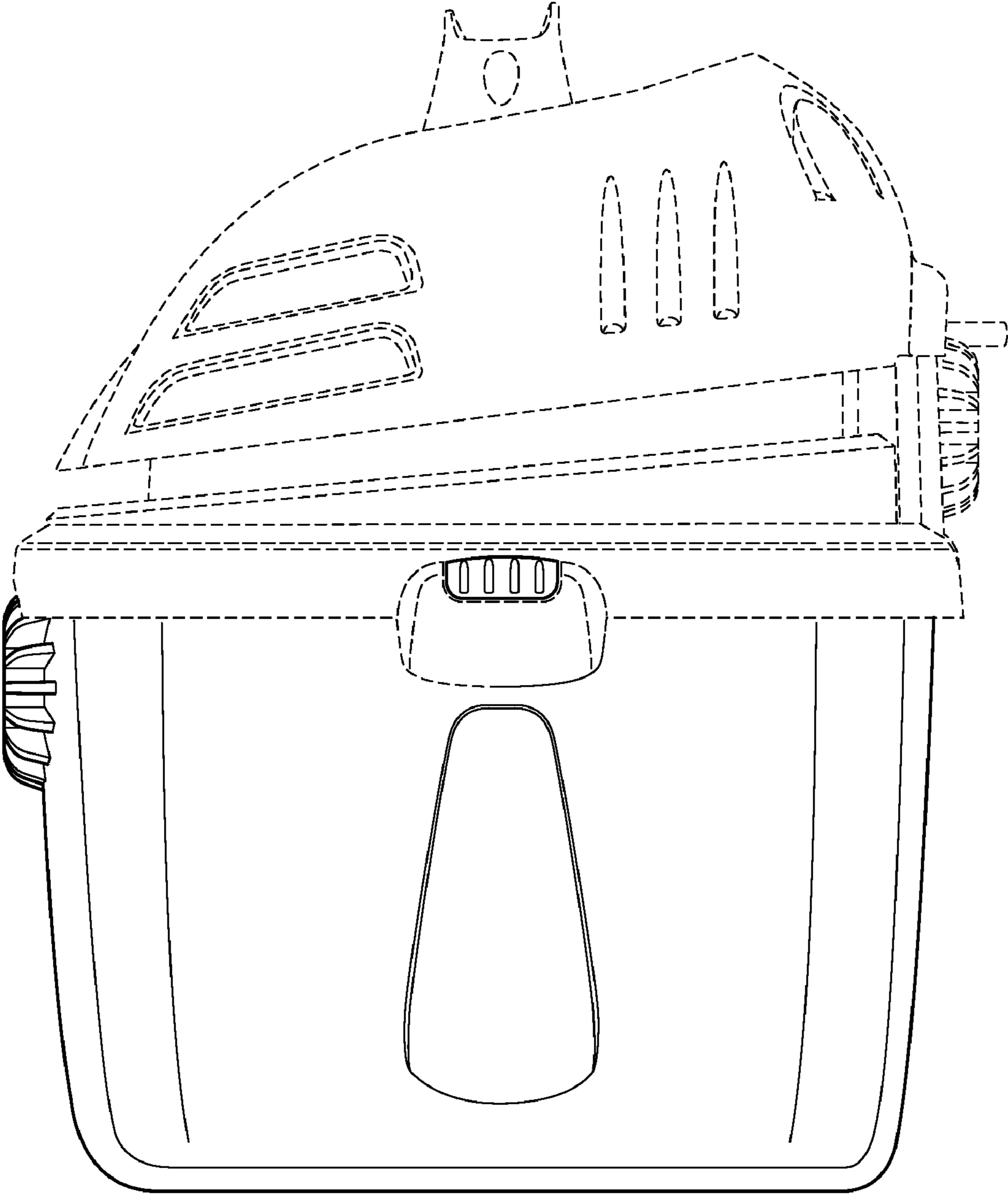

**FIG. 5**

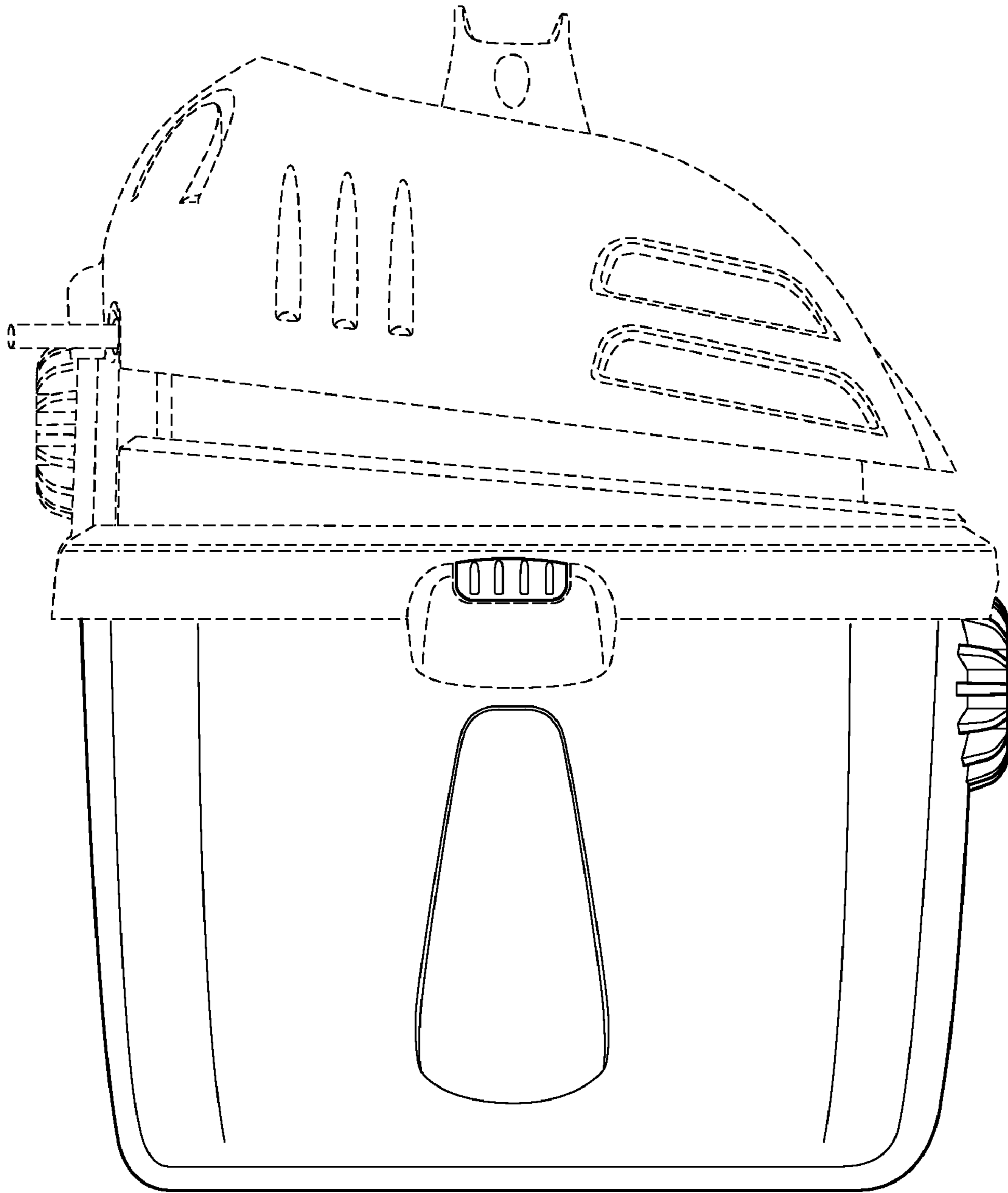

**FIG. 6**

