



US00D602579S

(12) **United States Design Patent**  
**Stone**

(10) **Patent No.:** **US D602,579 S**

(45) **Date of Patent:** **\*\* Oct. 20, 2009**

(54) **ROOF INTAKE VENT**

(75) Inventor: **Robert D. Stone**, Jacksonville, AR (US)

(73) Assignee: **Lomamo, Inc.**, Jacksonville, AR (US)

(\*\*) Term: **14 Years**

(21) Appl. No.: **29/331,525**

(22) Filed: **Jan. 27, 2009**

(51) **LOC (9) Cl.** ..... **23-04**

(52) **U.S. Cl.** ..... **D23/373**

(58) **Field of Classification Search** ..... D23/373,  
D23/393, 370, 371, 387, 391; 454/136, 141,  
454/146, 143, 153, 162, 364-368, 250-253,  
454/78, 260; 52/198, 199, 302.1, 57, 94,  
52/95; D25/119, 164, 55, 141  
See application file for complete search history.

(56) **References Cited**

**U.S. PATENT DOCUMENTS**

3,079,853	A *	3/1963	Smith	.....	454/365
4,817,506	A *	4/1989	Cashman	.....	454/365
6,277,024	B1 *	8/2001	Coulton	.....	454/365
6,371,847	B2 *	4/2002	Headrick	.....	454/365
6,491,581	B1 *	12/2002	Mankowski	.....	454/365
6,599,184	B2 *	7/2003	Morris	.....	454/365
6,684,581	B2 *	2/2004	Robinson et al.	.....	52/198
6,793,574	B1 *	9/2004	Robinson	.....	454/365

7,044,852	B2 *	5/2006	Horton	.....	454/365
D549,316	S *	8/2007	O'Hagin et al.	.....	D23/393
D555,237	S *	11/2007	O'Hagin	.....	D23/393
D574,947	S *	8/2008	Grisham et al.	.....	D23/393
D588,255	S *	3/2009	Daniels	.....	D23/373

\* cited by examiner

*Primary Examiner*—T. Chase Nelson

*Assistant Examiner*—David G Muller

(74) *Attorney, Agent, or Firm*—Joe D. Calhoun

(57) **CLAIM**

The ornamental design for a roof intake vent, as shown and described.

**DESCRIPTION**

FIG. 1 depicts a top isomeric perspective view of the roof exhaust vent.

FIG. 2 depicts a top plan view thereof.

FIG. 3 depicts a bottom plan view thereof.

FIG. 4 depicts a bottom isomeric view thereof.

FIG. 5 depicts a front elevation view thereof.

FIG. 6 depicts a rear elevation view thereof.

FIG. 7 depicts a left side elevation view thereof; and,

FIG. 8 depicts a right side elevation view thereof.

**1 Claim, 8 Drawing Sheets**

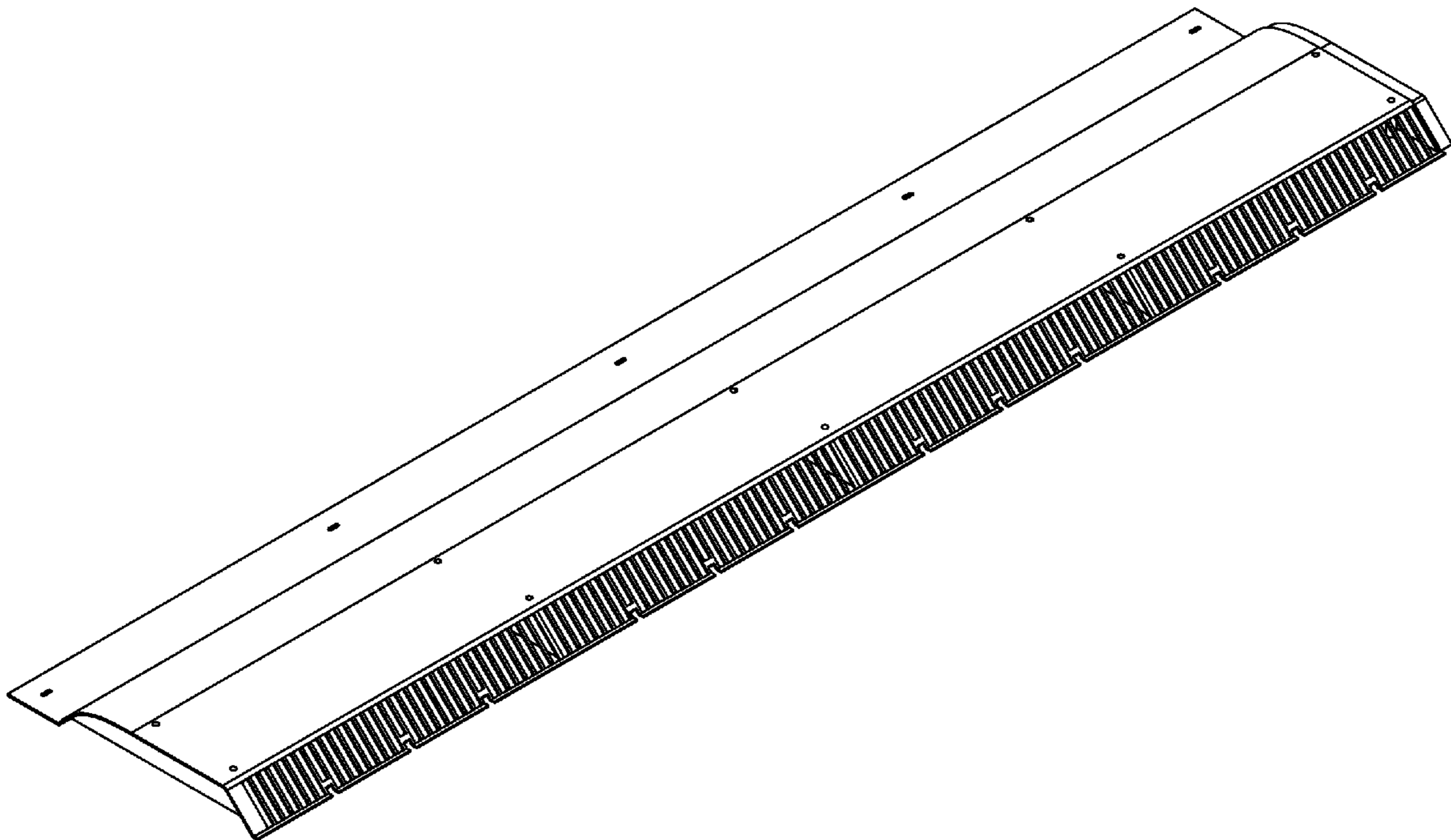

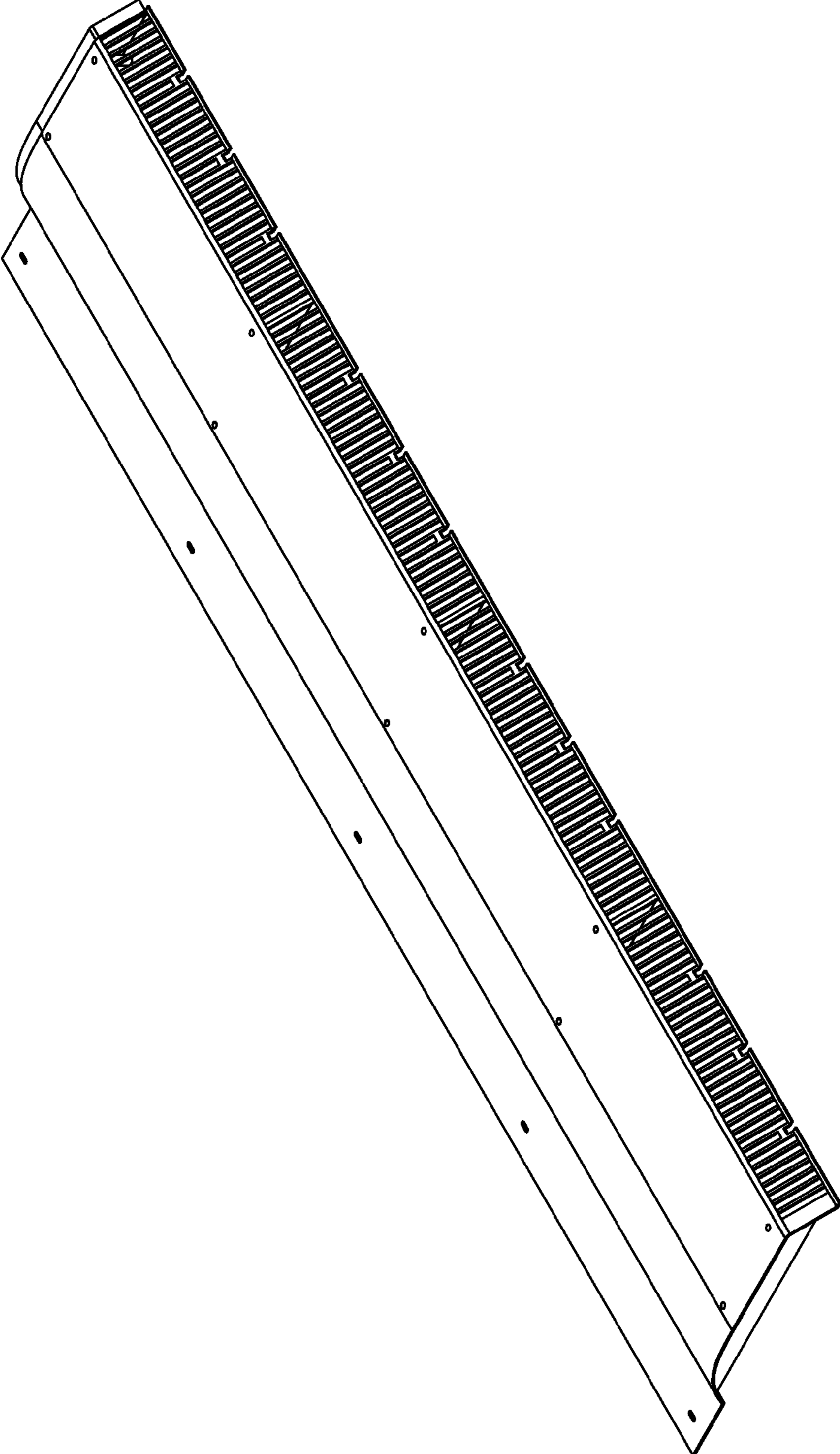

Figure 1.

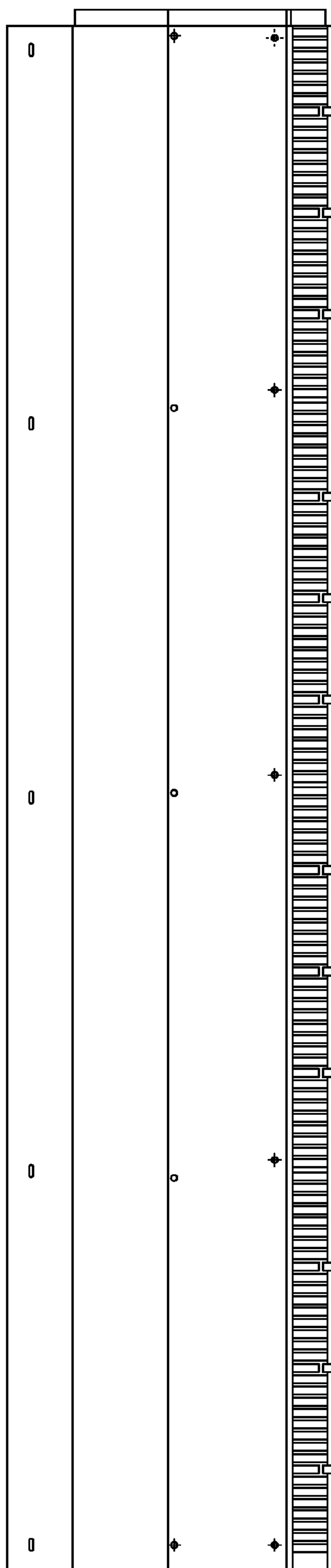

Figure 2.

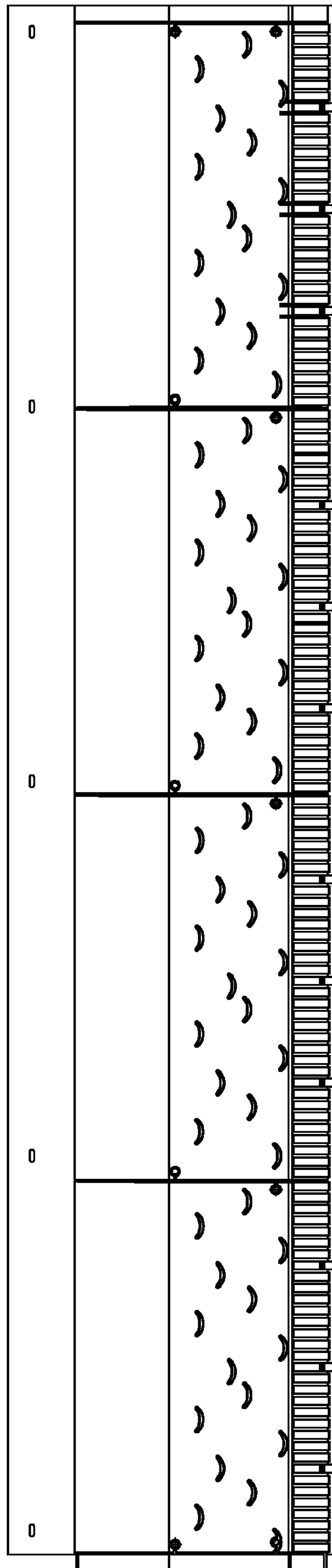

Figure 3.

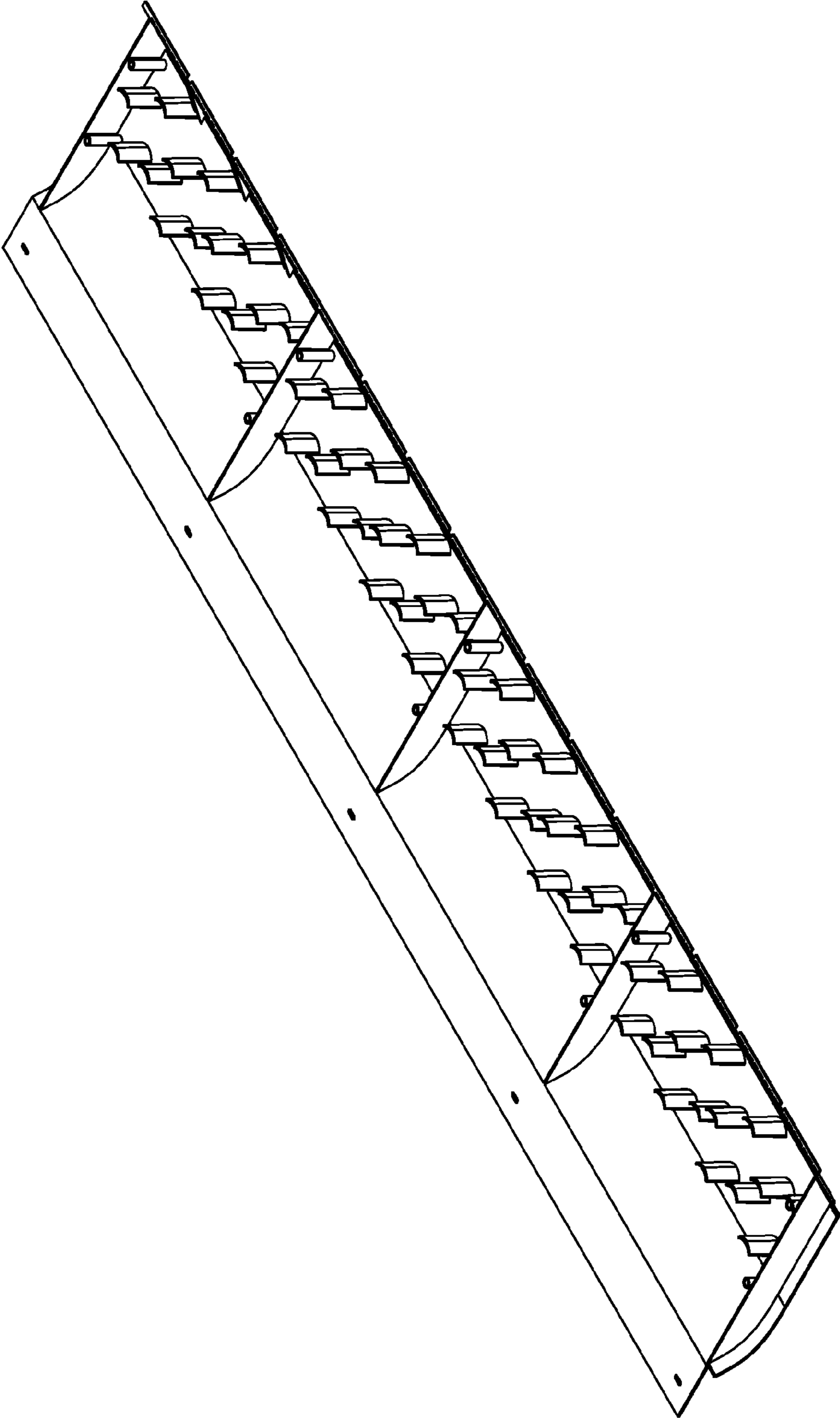
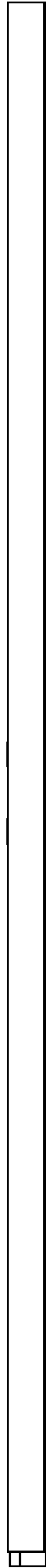

Figure 4.



**Figure 5.**



**Figure 6.**

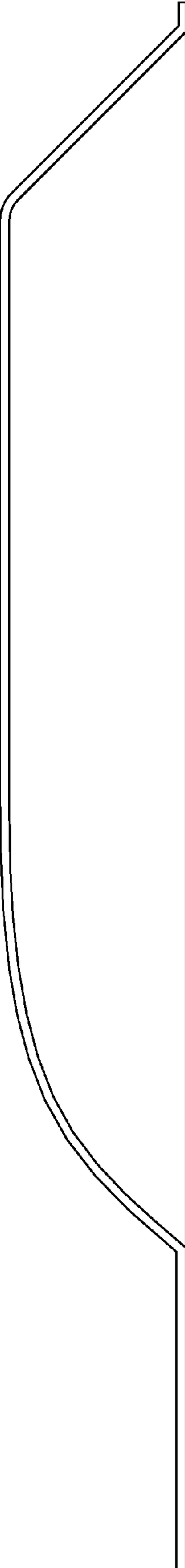

Figure 7.



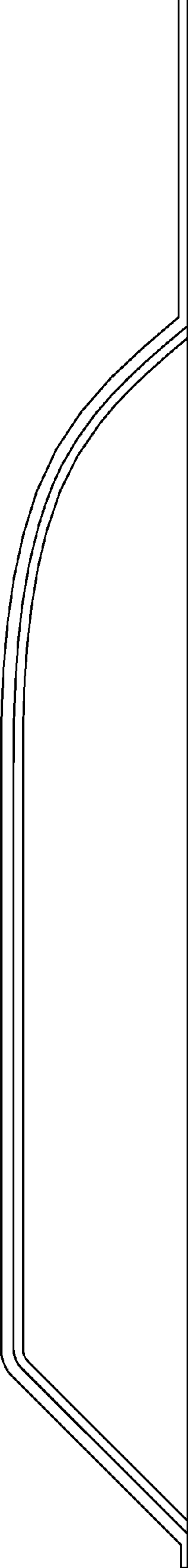

Figure 8.