



US00D602548S

(12) **United States Design Patent**
Oldknow

(10) **Patent No.:** **US D602,548 S**

(45) **Date of Patent:** **** Oct. 20, 2009**

(54) **GOLF CLUB HEAD**

(75) Inventor: **Andrew G. V. Oldknow**, Portland, OR
(US)

(73) Assignee: **NIKE, Inc.**, Beaverton, OR (US)

(**) Term: **14 Years**

(21) Appl. No.: **29/338,893**

(22) Filed: **Jun. 19, 2009**

(51) **LOC (9) Cl.** **21-02**

(52) **U.S. Cl.** **D21/759**

(58) **Field of Classification Search** D21/733,
D21/752, 759; 473/324–331, 343–346
See application file for complete search history.

(56) **References Cited**

U.S. PATENT DOCUMENTS

D354,325 S *	1/1995	Henwood	D21/752
D414,234 S *	9/1999	Darrah	D21/759
D458,325 S	6/2002	Antonious		
D461,865 S	8/2002	Nagai et al.		
D508,544 S	8/2005	Madore		
D532,469 S	11/2006	Oldknow		
D532,470 S	11/2006	Oldknow		
D532,471 S	11/2006	Oldknow		
D532,853 S	11/2006	Oldknow		
D532,854 S	11/2006	Oldknow		
D532,855 S	11/2006	Madore et al.		
D543,253 S	5/2007	Oldknow		
D543,600 S	5/2007	Oldknow		
D544,058 S	6/2007	Oldknow		
D544,557 S	6/2007	Oldknow		
D544,558 S	6/2007	Oldknow		
D544,559 S	6/2007	Oldknow		
D544,560 S	6/2007	Oldknow		
D544,561 S	6/2007	Oldknow		
D548,295 S	8/2007	Jertson et al.		
D550,318 S	9/2007	Oldknow		
D577,400 S *	9/2008	Oldknow et al.	D21/759
D577,401 S	9/2008	Oldknow et al.		
D577,402 S	9/2008	Oldknow et al.		
D577,403 S *	9/2008	Oldknow et al.	D21/759
D577,404 S *	9/2008	Oldknow et al.	D21/759
D577,405 S	9/2008	Oldknow et al.		
D577,406 S *	9/2008	Oldknow et al.	D21/759

D577,784 S *	9/2008	Oldknow et al.	D21/759
D577,785 S *	9/2008	Oldknow et al.	D21/759
D577,786 S *	9/2008	Oldknow et al.	D21/759
D577,787 S *	9/2008	Oldknow et al.	D21/759
D577,788 S *	9/2008	Oldknow et al.	D21/759
D578,174 S	10/2008	Tang et al.		
D580,504 S	11/2008	Bosilkovski et al.		
D585,101 S *	1/2009	Glod	D21/752
D587,772 S	3/2009	Ferguson et al.		
D588,223 S *	3/2009	Kuan	D21/759
D591,818 S	5/2009	Roberts et al.		
2008/0171612 A1	7/2008	Serrano et al.		
2009/0082135 A1	3/2009	Evans et al.		

OTHER PUBLICATIONS

Edwin Watts Golf, Summer 2003, p. 36. A Trimetal II Drivers & Fairway Woods.

Edwin Watts Golf, Holiday 2004, p. 12, V-Steele Fairway Woods.

Edwin Watts Golf, Late Spring 2004, p. 11, King Cobra-Titanium SZ Drivers.

Austad's Golf, Spring 2008, p. 8, Nike SQ Sumo 5900 Ti Drivers.

* cited by examiner

Primary Examiner—Mitchell I Siegel

(74) *Attorney, Agent, or Firm*—Banner & Witcoff, Ltd.

(57) **CLAIM**

The ornamental design for a golf club head, as shown and described.

DESCRIPTION

FIG. 1 is a perspective view of a golf club head showing my new design;

FIG. 2 is a bottom view thereof;

FIG. 3 is a rear view thereof;

FIG. 4 is a heel end view thereof;

FIG. 5 is a toe end view thereof;

FIG. 6 is a front view thereof; and,

FIG. 7 is a top view thereof.

The broken line showing of the remainder of the golf club head is for environmental purposes only and forms no part of the claimed design.

1 Claim, 4 Drawing Sheets

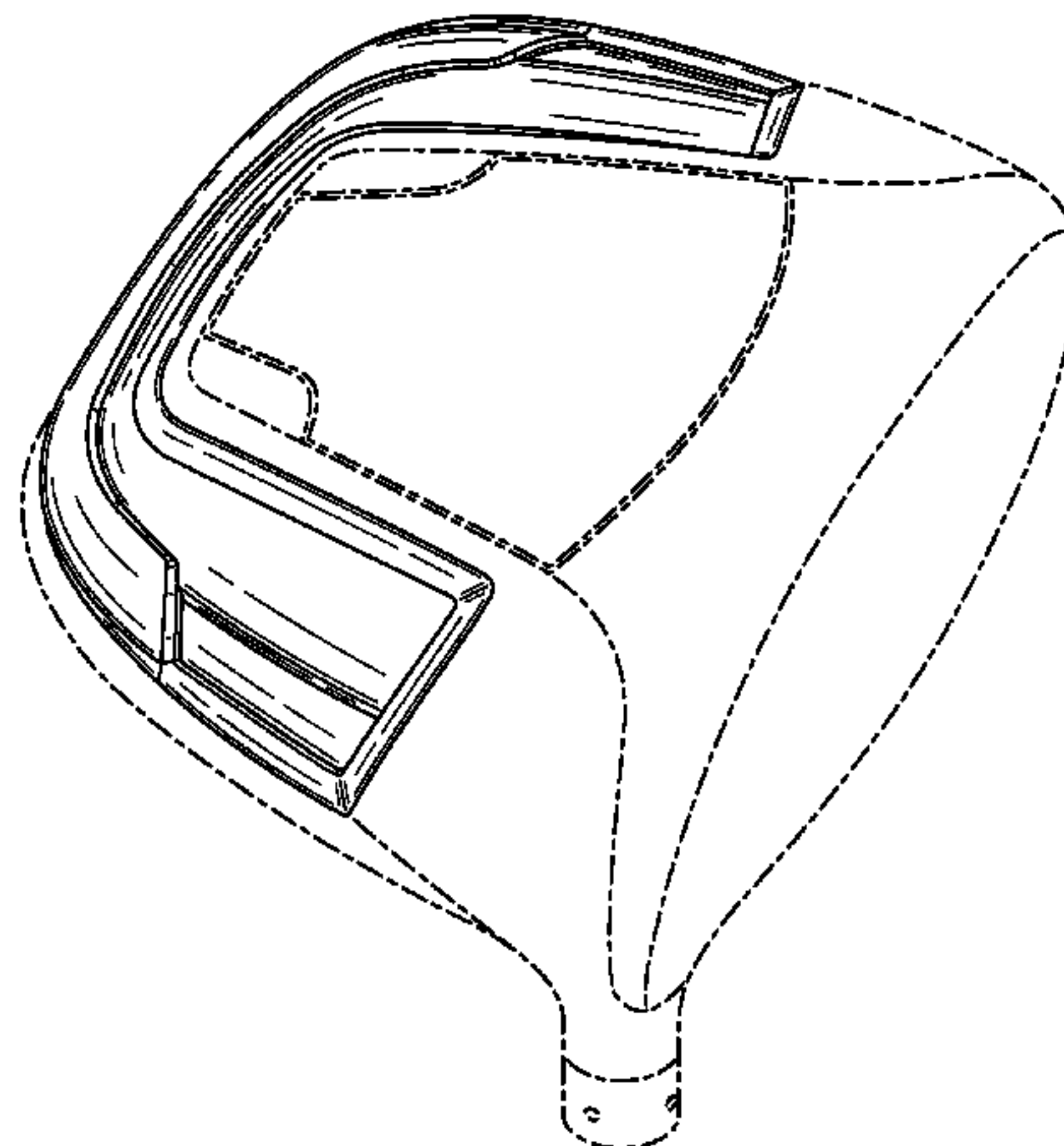

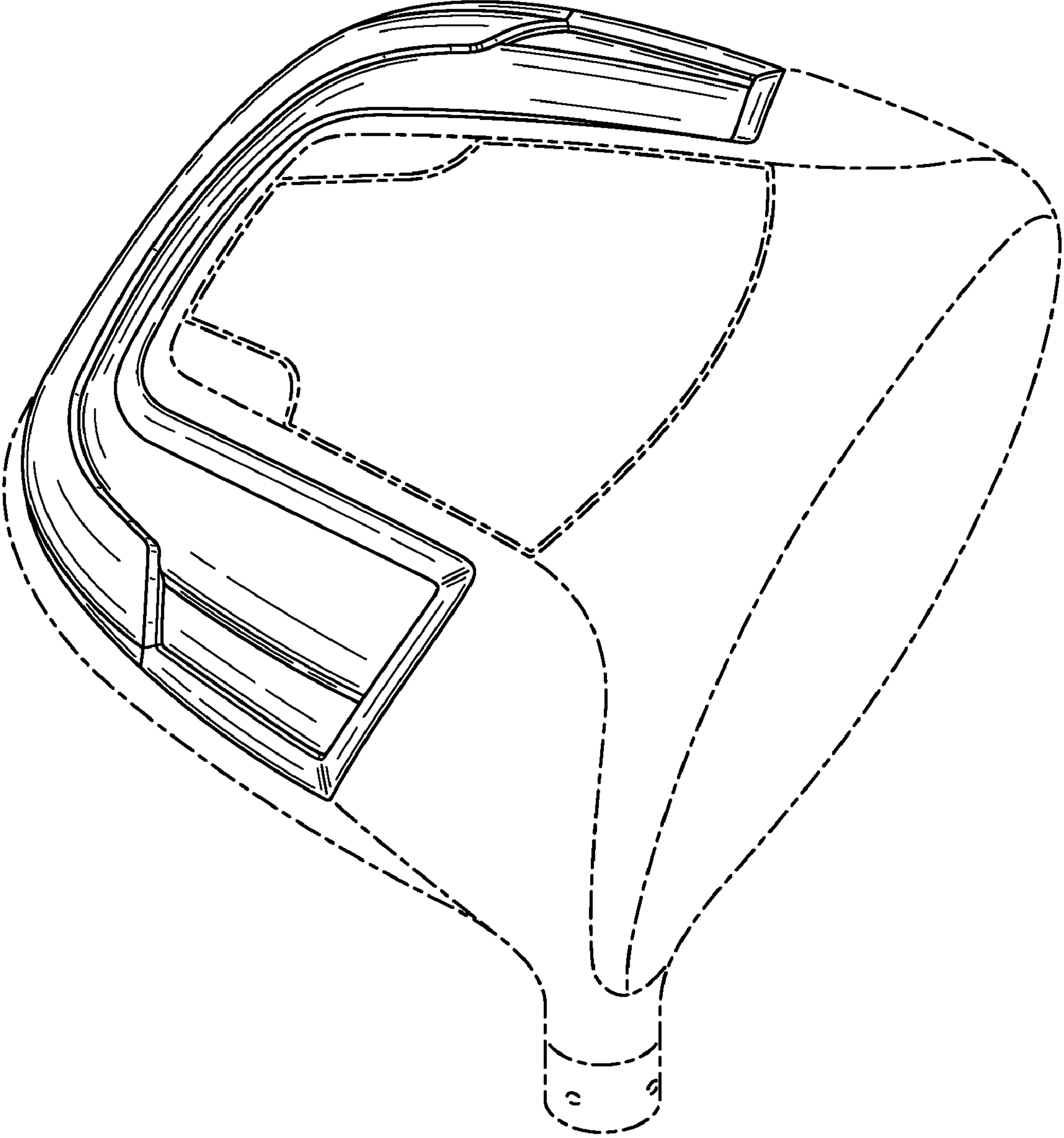

FIG. 1

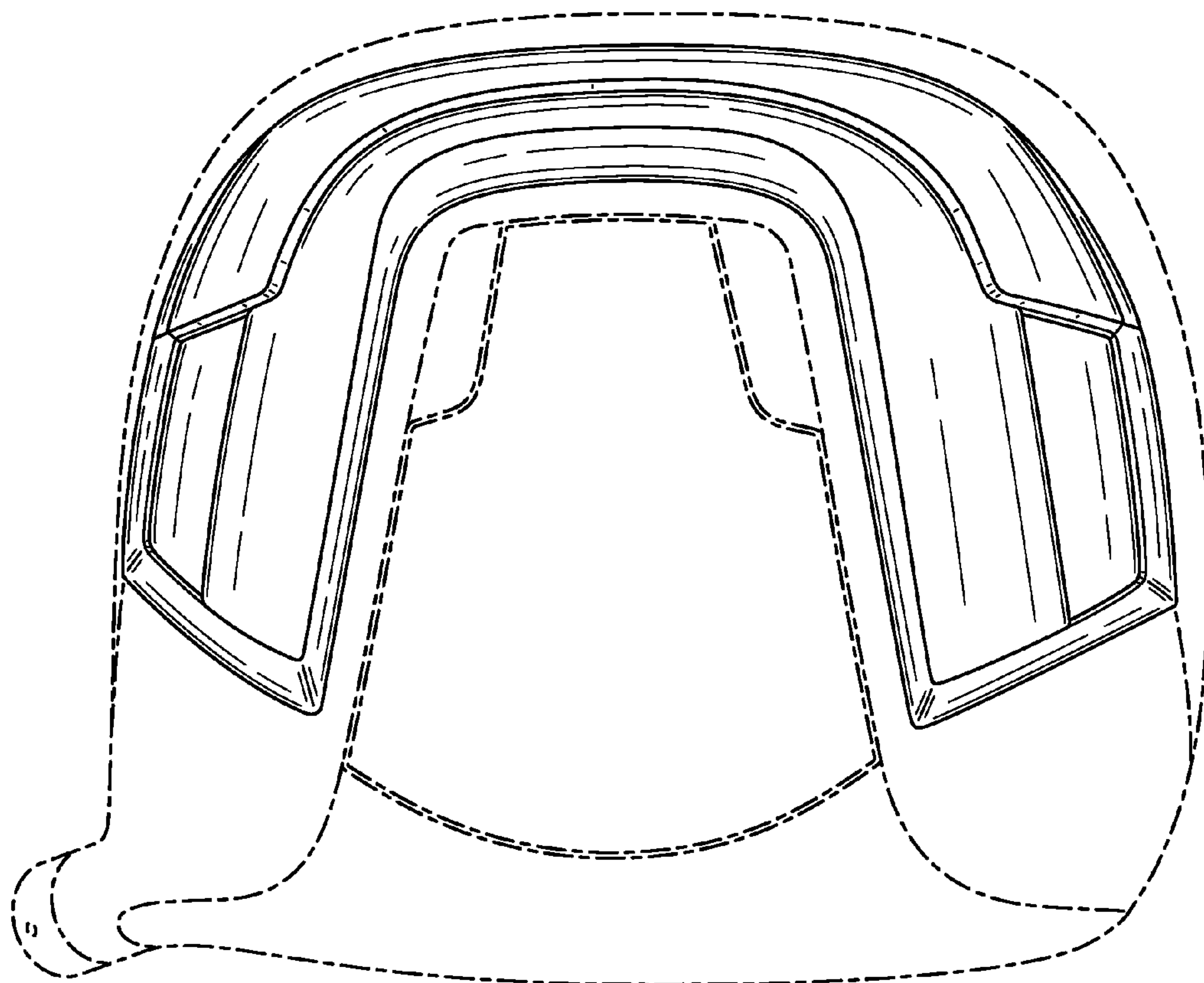

FIG. 2

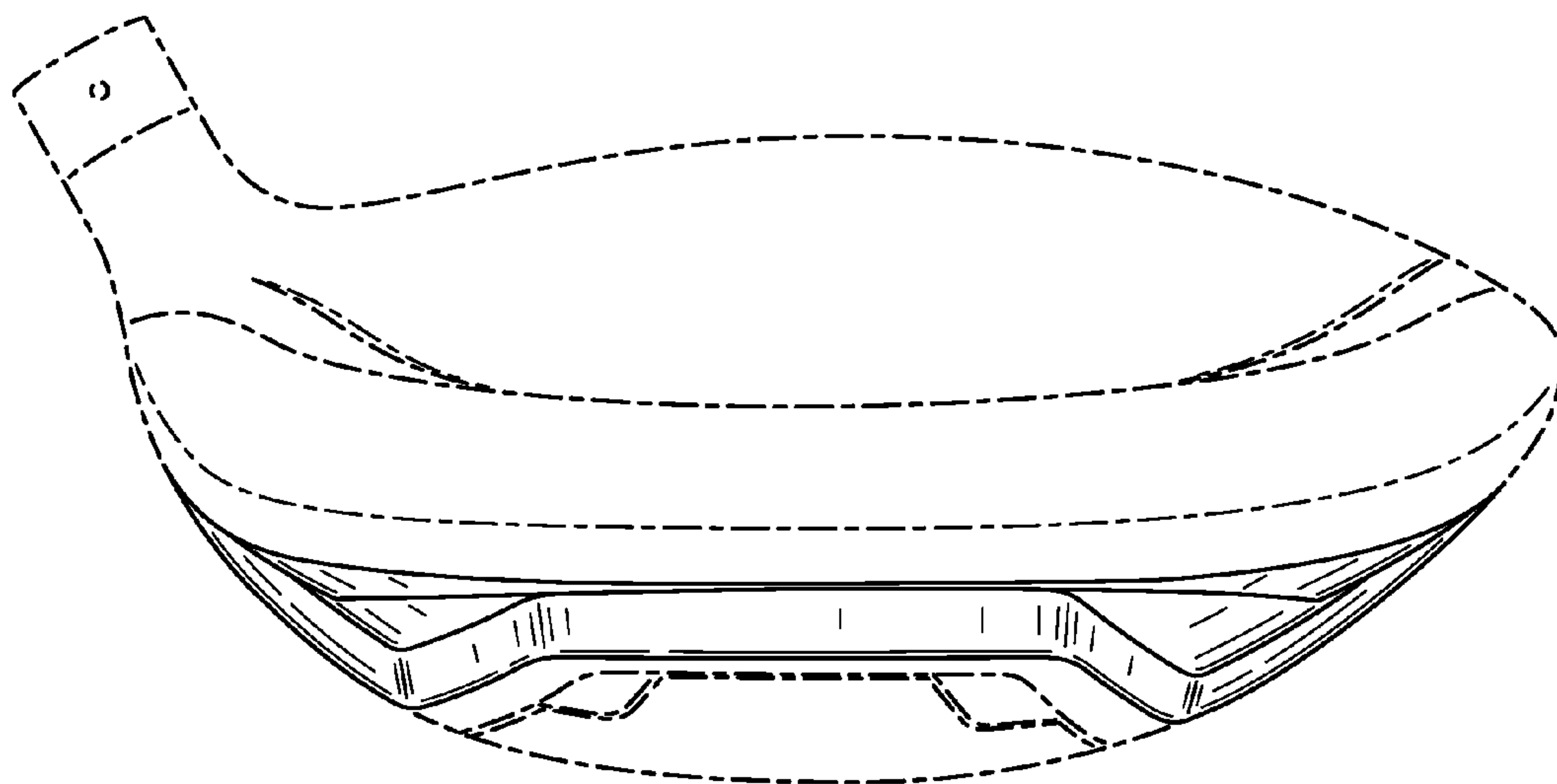

FIG. 3

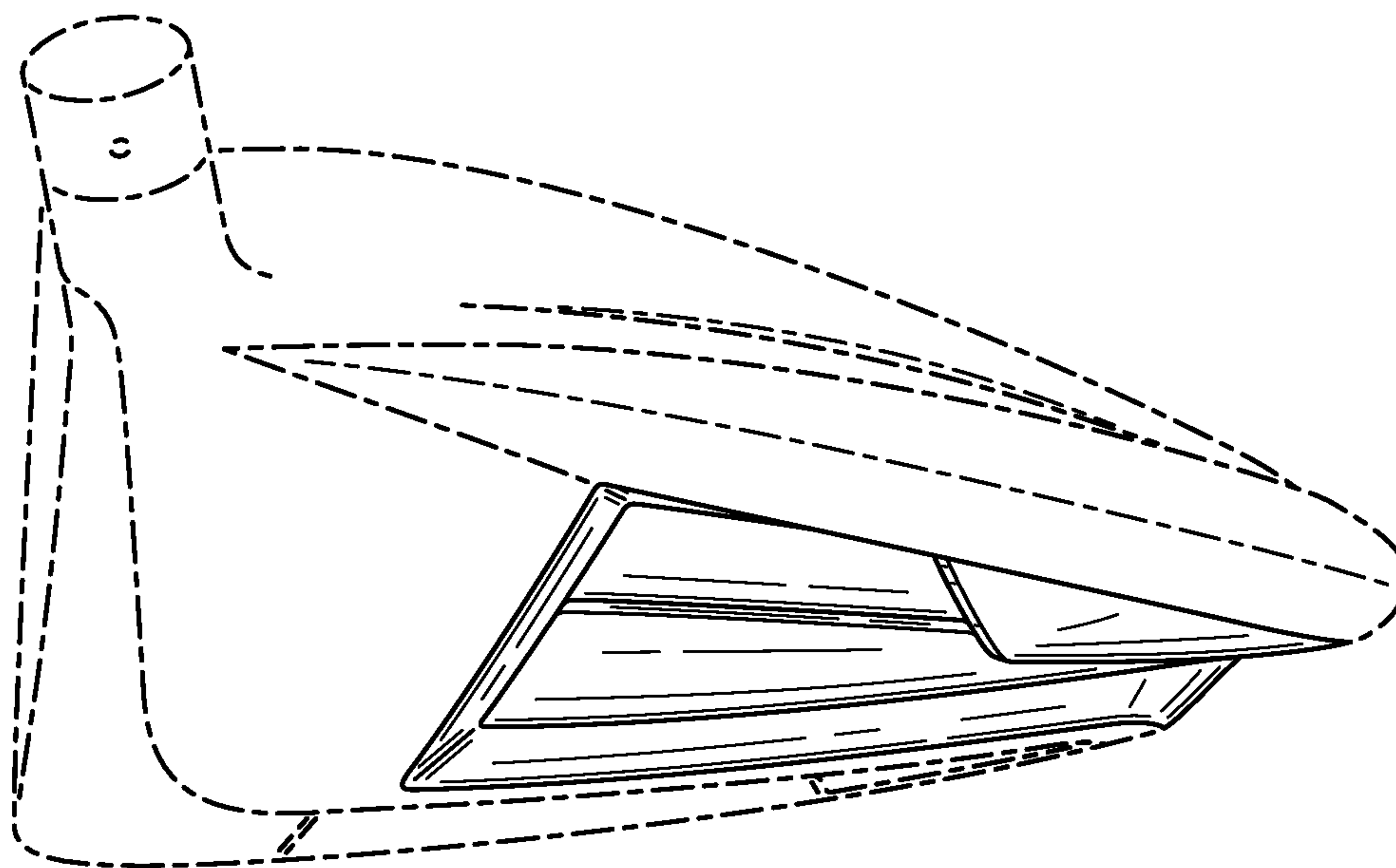

FIG. 4

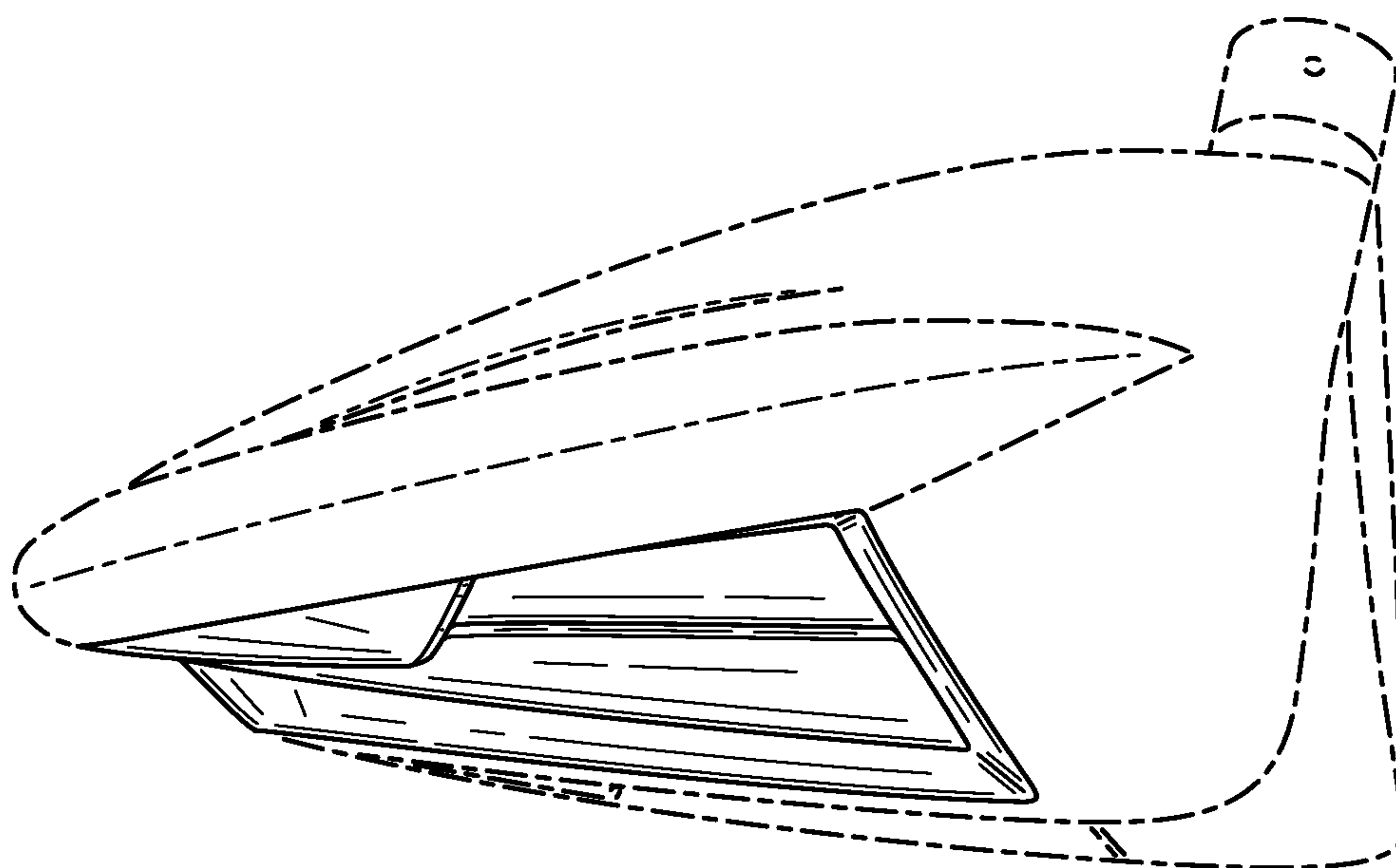

FIG. 5

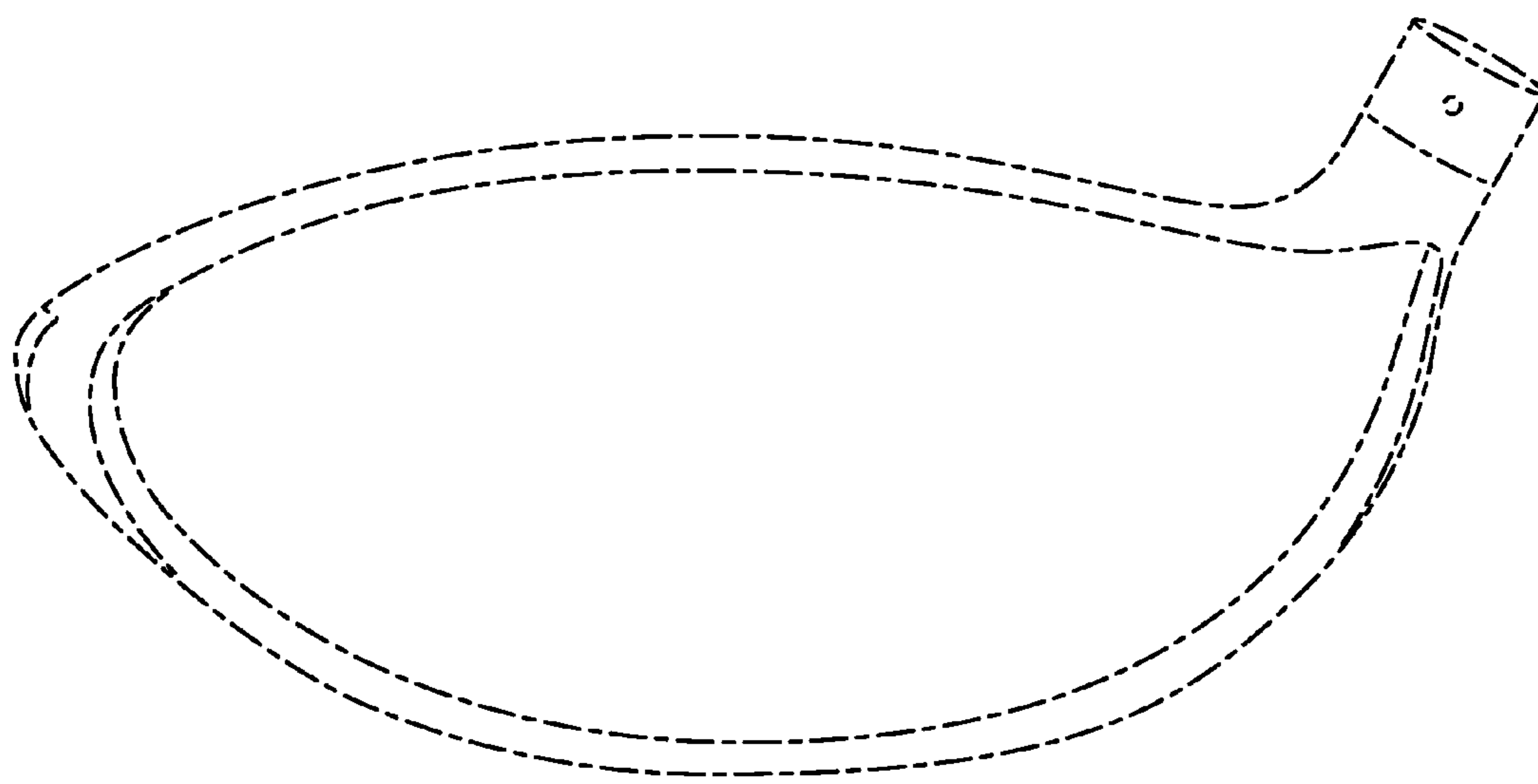

FIG. 6

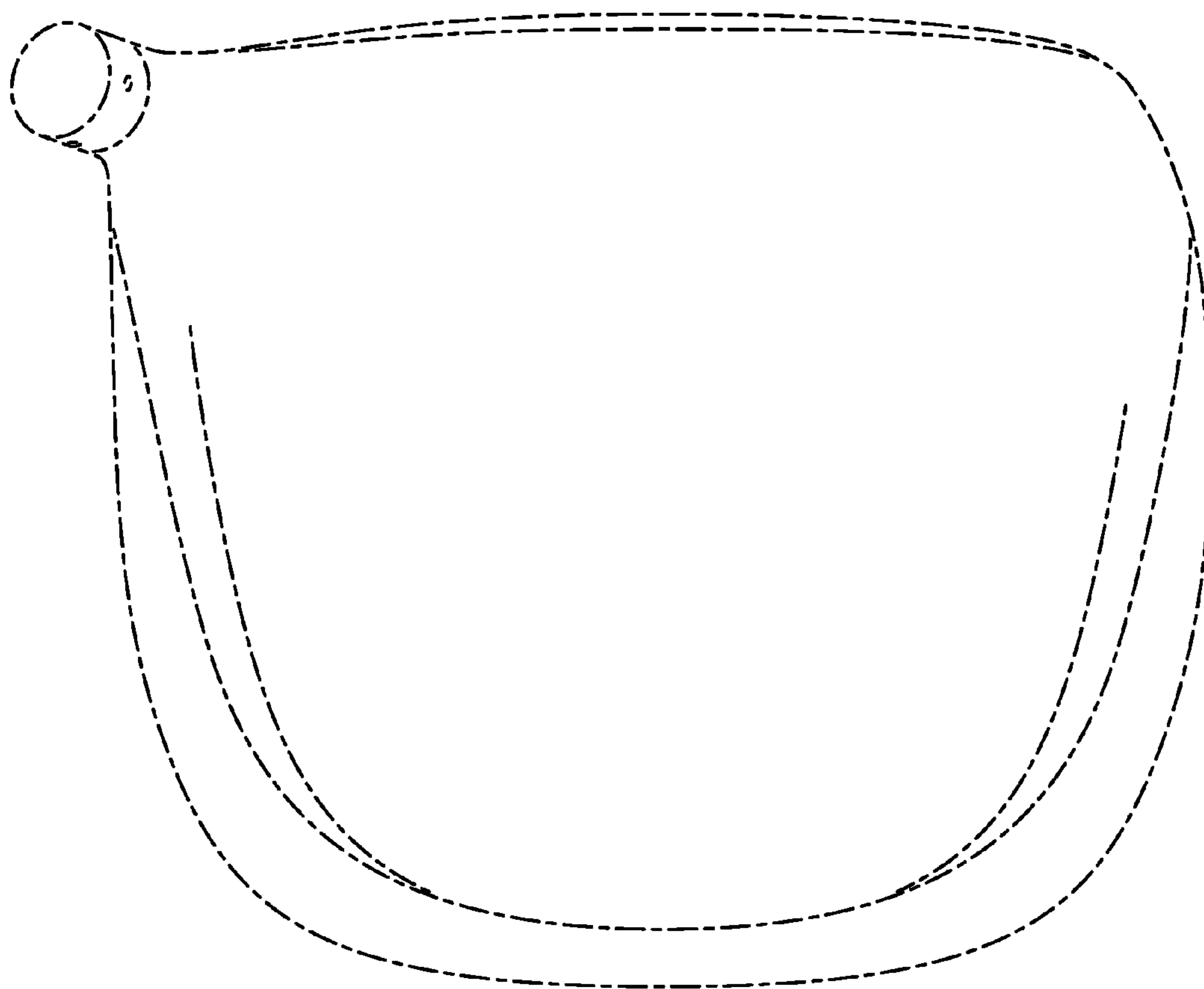

FIG. 7