



US00D602540S

(12) **United States Design Patent**  
**Minter**

(10) **Patent No.:** **US D602,540 S**

(45) **Date of Patent:** **\*\* Oct. 20, 2009**

(54) **EXERCISE APPARATUS**

(75) Inventor: **Mark Clive Minter**, London (GB)

(73) Assignee: **Power Plate North America, Inc.**,  
Irvine, CA (US)

(\*\*) Term: **14 Years**

(21) Appl. No.: **29/306,718**

(22) Filed: **Apr. 15, 2008**

(51) **LOC (9) Cl.** ..... **21-02**

(52) **U.S. Cl.** ..... **D21/662**

(58) **Field of Classification Search** ..... D21/662,  
D21/671, 686, 688, 689; 601/23, 49, 51,  
601/66, 70, 90; 482/27, 51, 145, 146, 91,  
482/112, 113

See application file for complete search history.

(56) **References Cited**

**U.S. PATENT DOCUMENTS**

D500,100 S *	12/2004	van der Meer	.....	D21/662
D518,533 S *	4/2006	van der Meer	.....	D21/662
D522,074 S *	5/2006	Dummel	.....	D21/662
D538,358 S *	3/2007	Glier	.....	D21/662
D548,291 S *	8/2007	Chiang	.....	D21/662
7,278,976 B1 *	10/2007	Chen	.....	601/30
D559,924 S *	1/2008	Wu	.....	D21/661
D561,273 S *	2/2008	Wu	.....	D21/662
D567,309 S *	4/2008	Schuurman et al.	.....	D21/662

D571,416 S \* 6/2008 Wu ..... D21/662  
D574,900 S \* 8/2008 Meile Marcel Tamminga .. D21/  
662

D576,228 S \* 9/2008 Hahn ..... D21/668  
2005/0131319 A1 \* 6/2005 der Meer ..... 601/49

\* cited by examiner

*Primary Examiner*—Philip S Hyder

(74) *Attorney, Agent, or Firm*—Levenfeld Pearlstein, LLC

(57) **CLAIM**

The ornamental design for an exercise apparatus, as shown and described.

**DESCRIPTION**

FIG. 1 is a back side elevated perspective view of an exercise apparatus, made according to the new design;

FIG. 2 is a back plan view of the exercise apparatus of FIG. 1;

FIG. 3 is a front plan view of the exercise apparatus of FIG. 1;

FIG. 4 is a right side plan view of the exercise apparatus of FIG. 1;

FIG. 5 is a left side plan view of the exercise apparatus of FIG. 1;

FIG. 6 is a top plan view of the exercise apparatus of FIG. 1; and,

FIG. 7 is a bottom plan view of the exercise apparatus of FIG. 1.

**1 Claim, 6 Drawing Sheets**

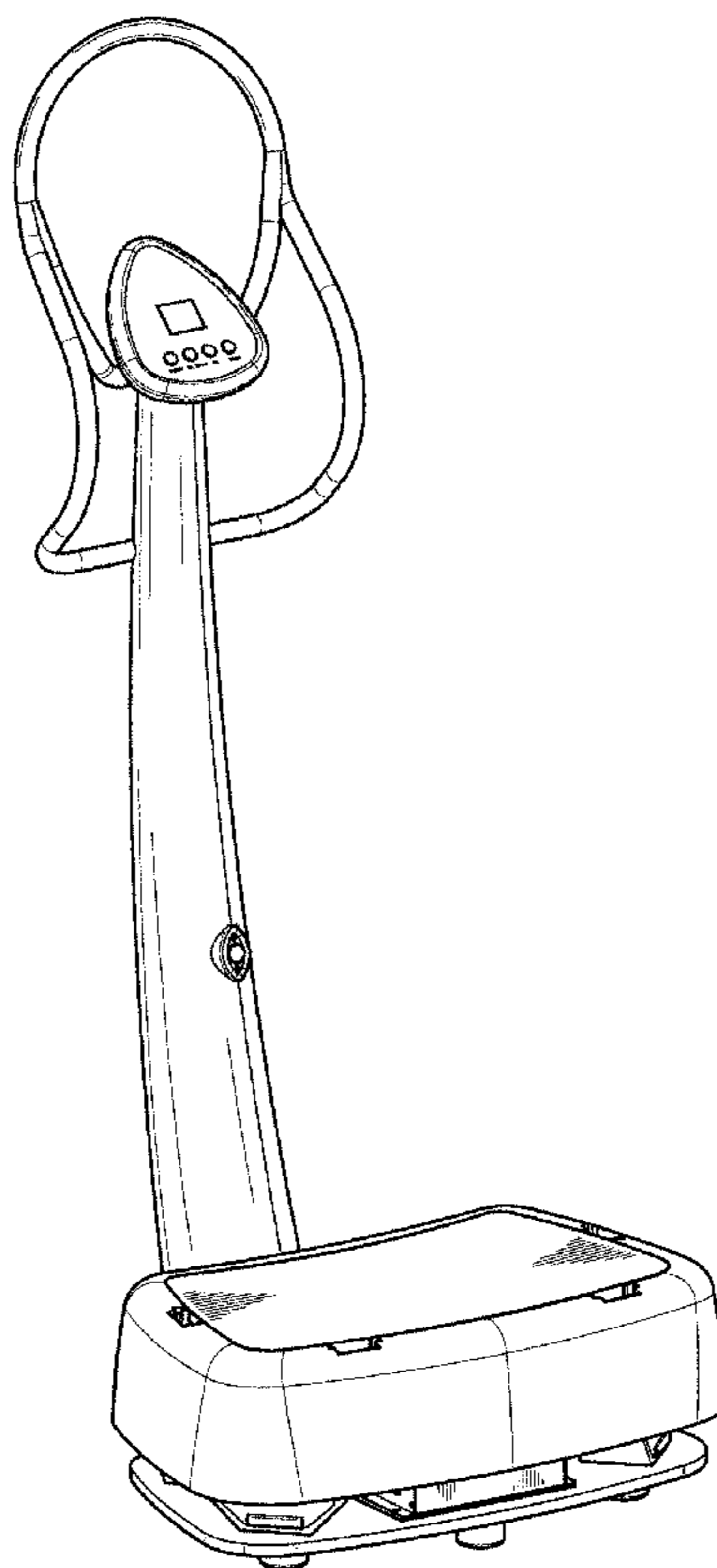

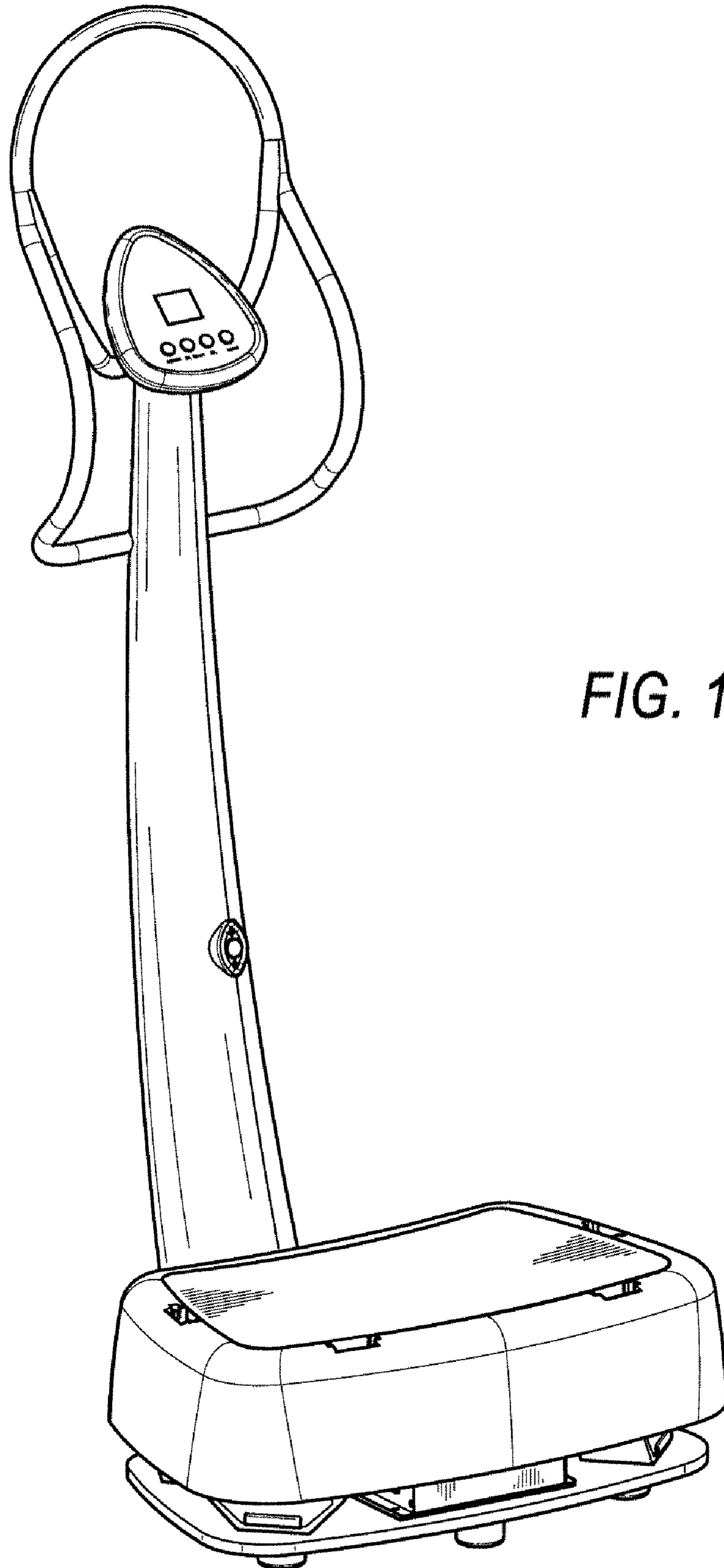

*FIG. 1*

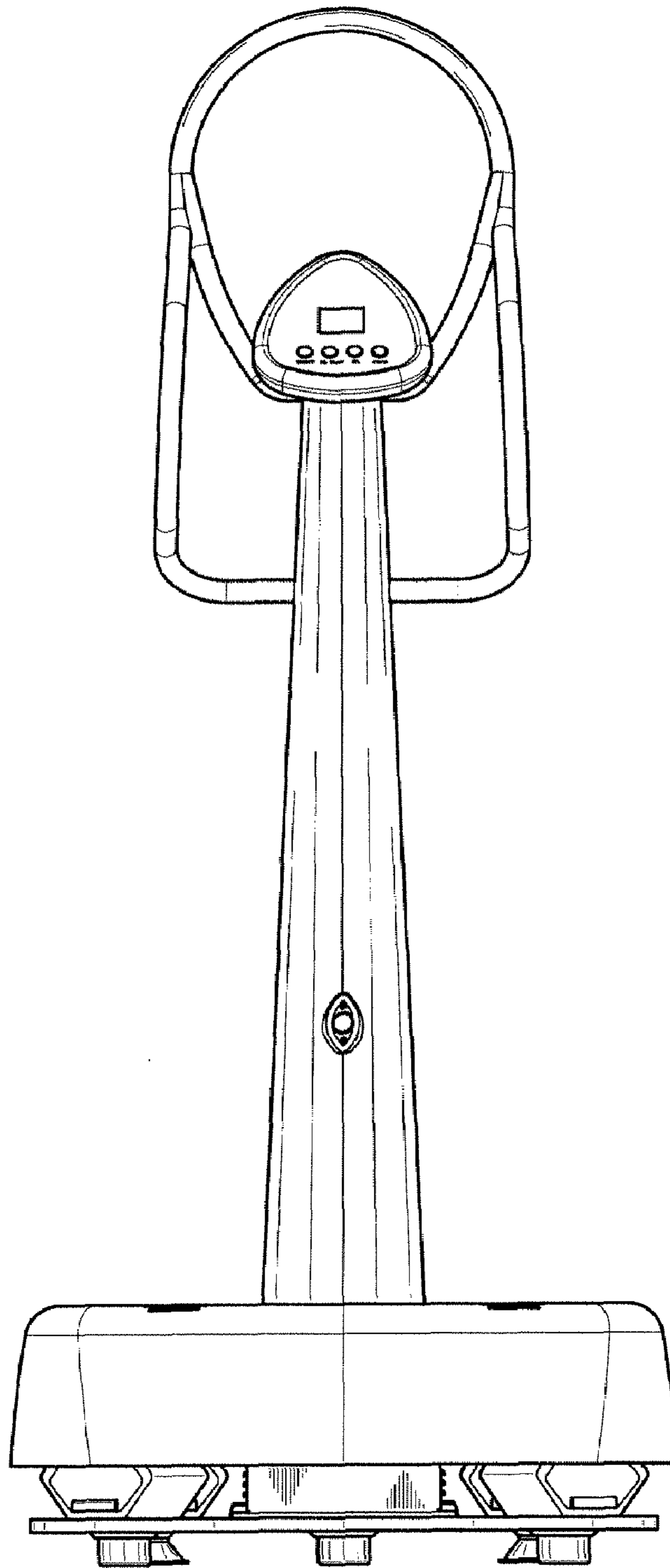

FIG. 2

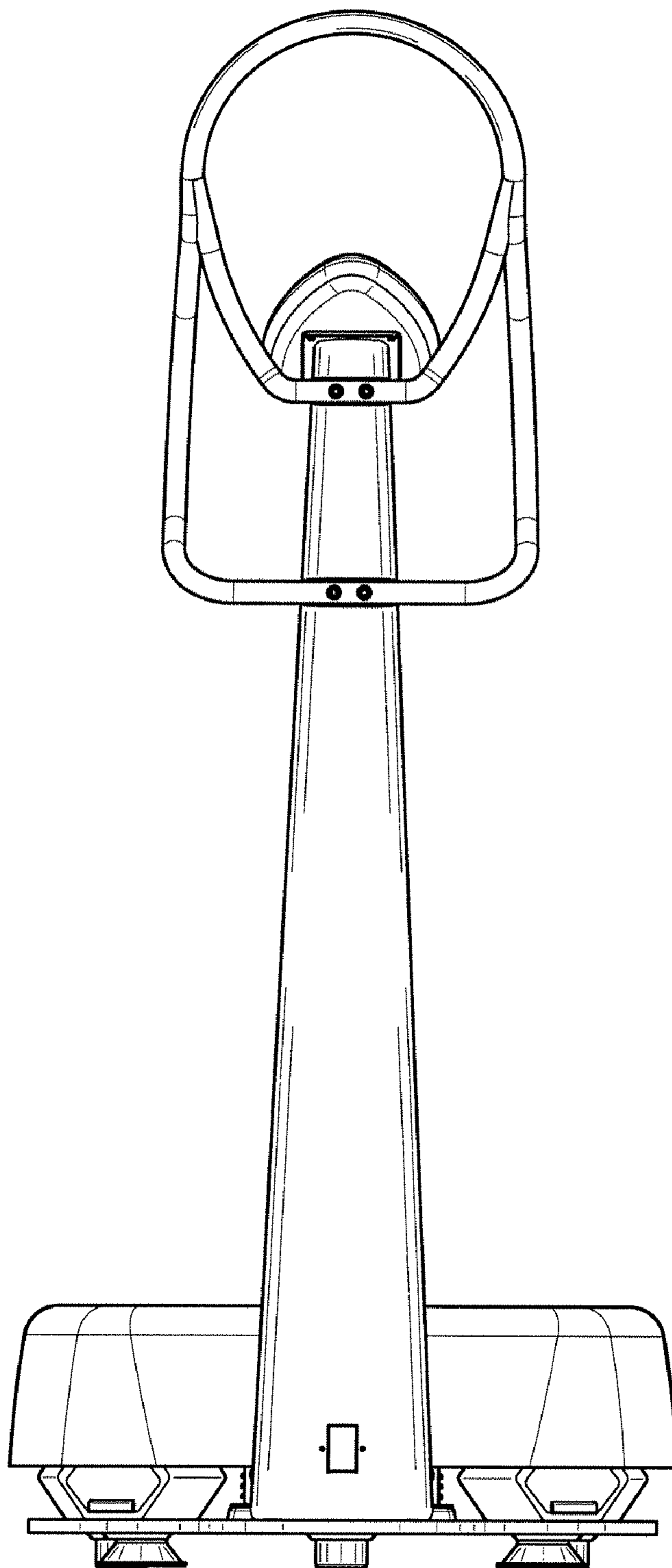

FIG. 3

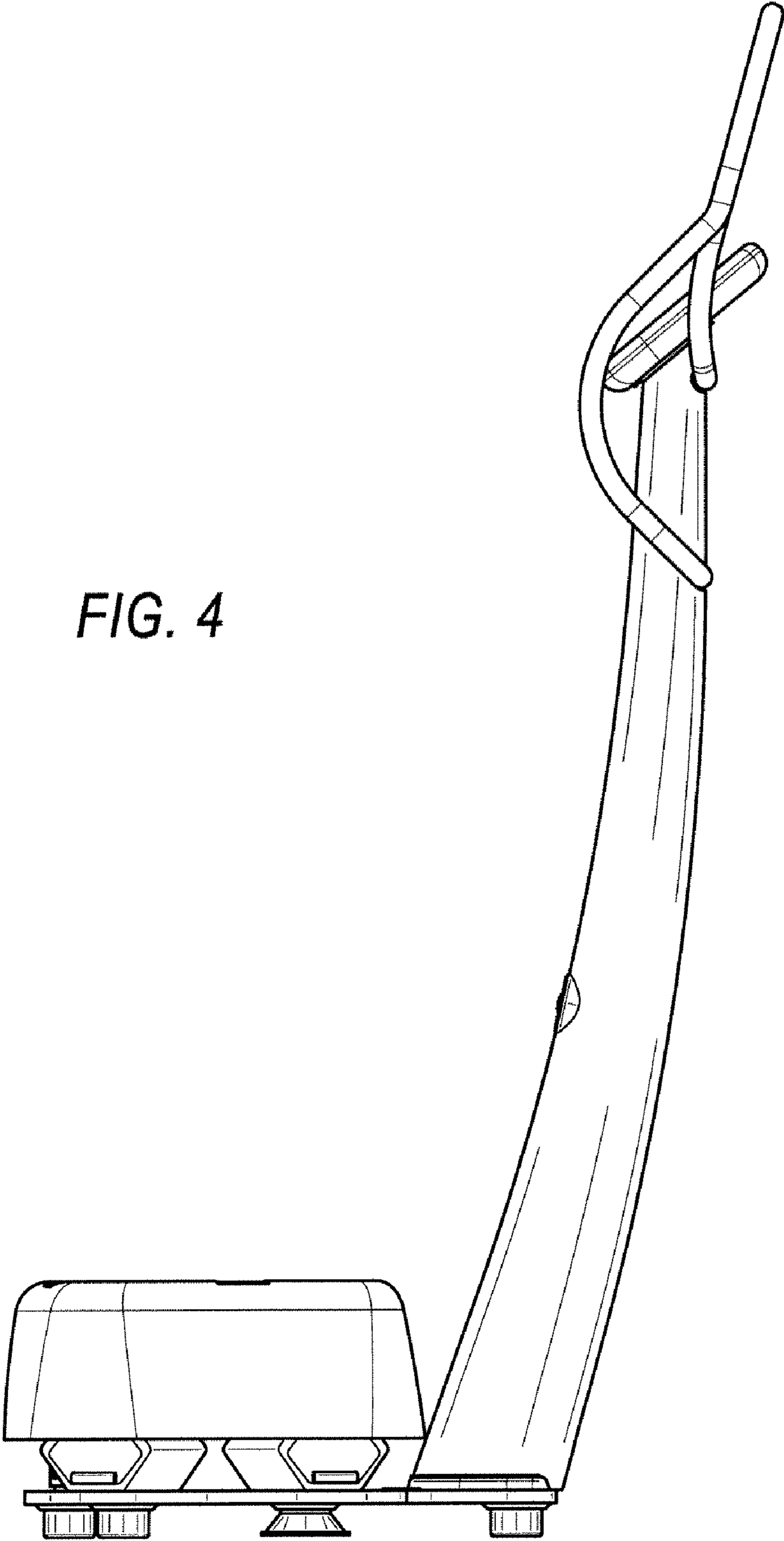

FIG. 4

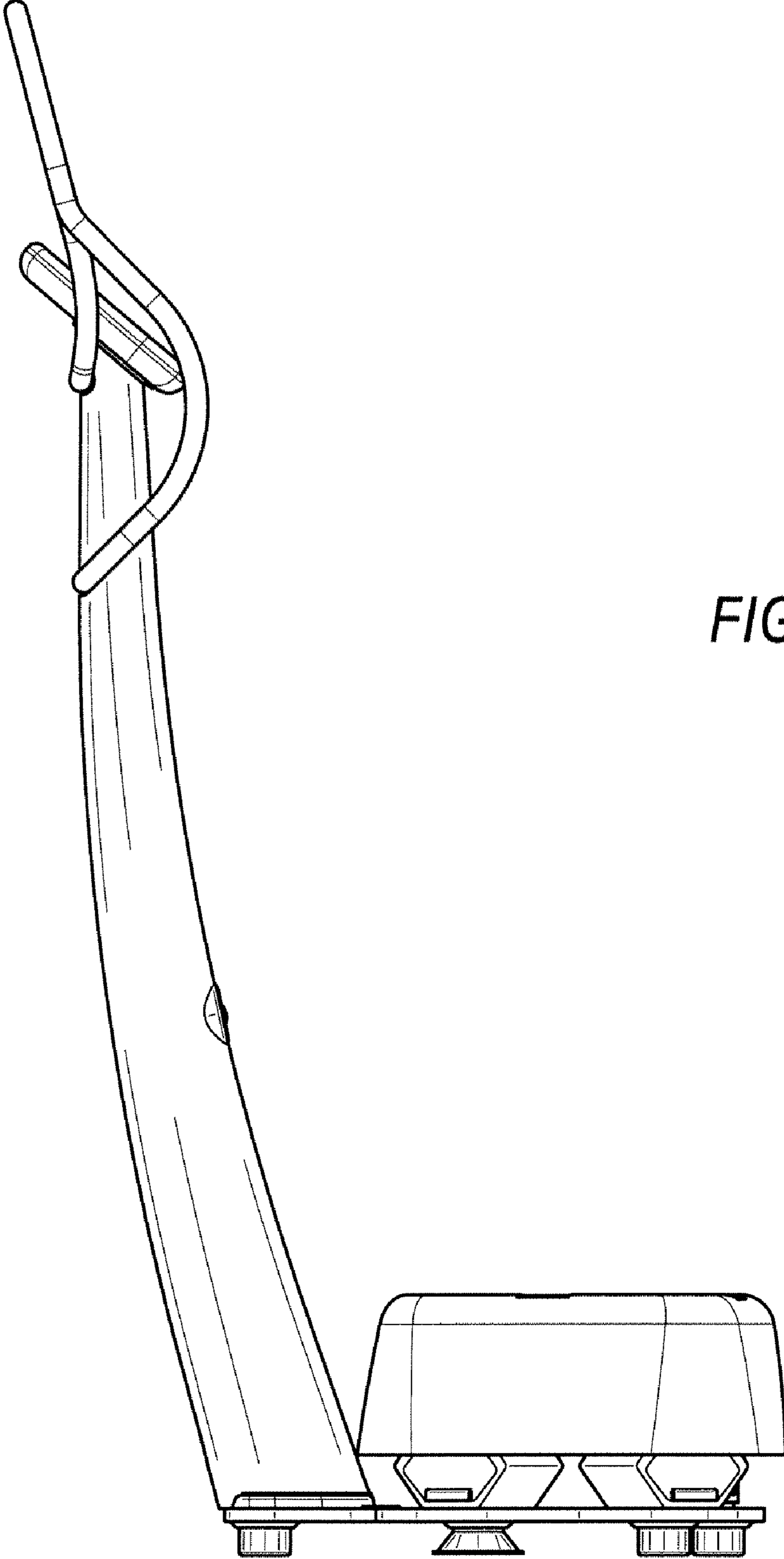

FIG. 5

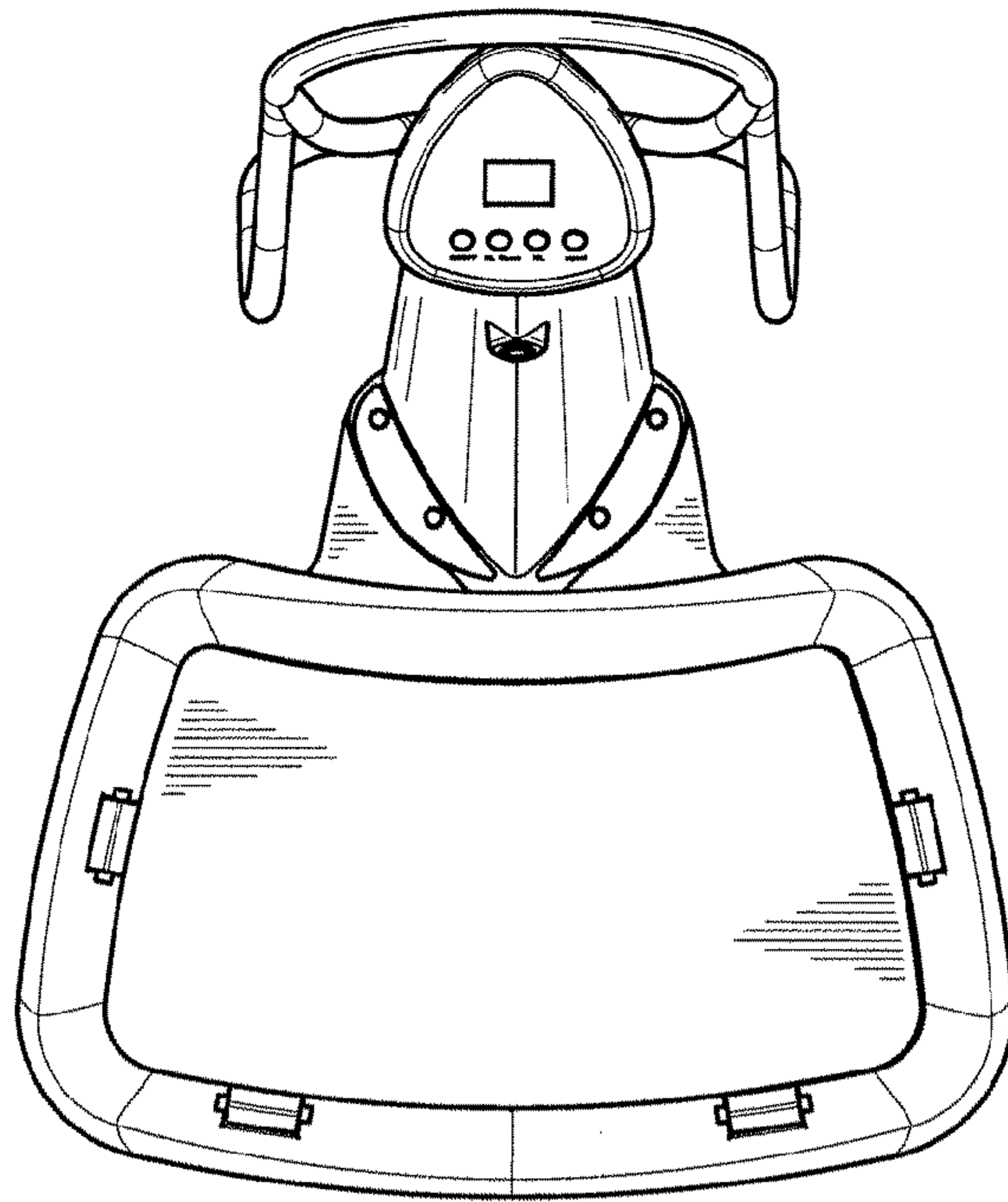

FIG. 6

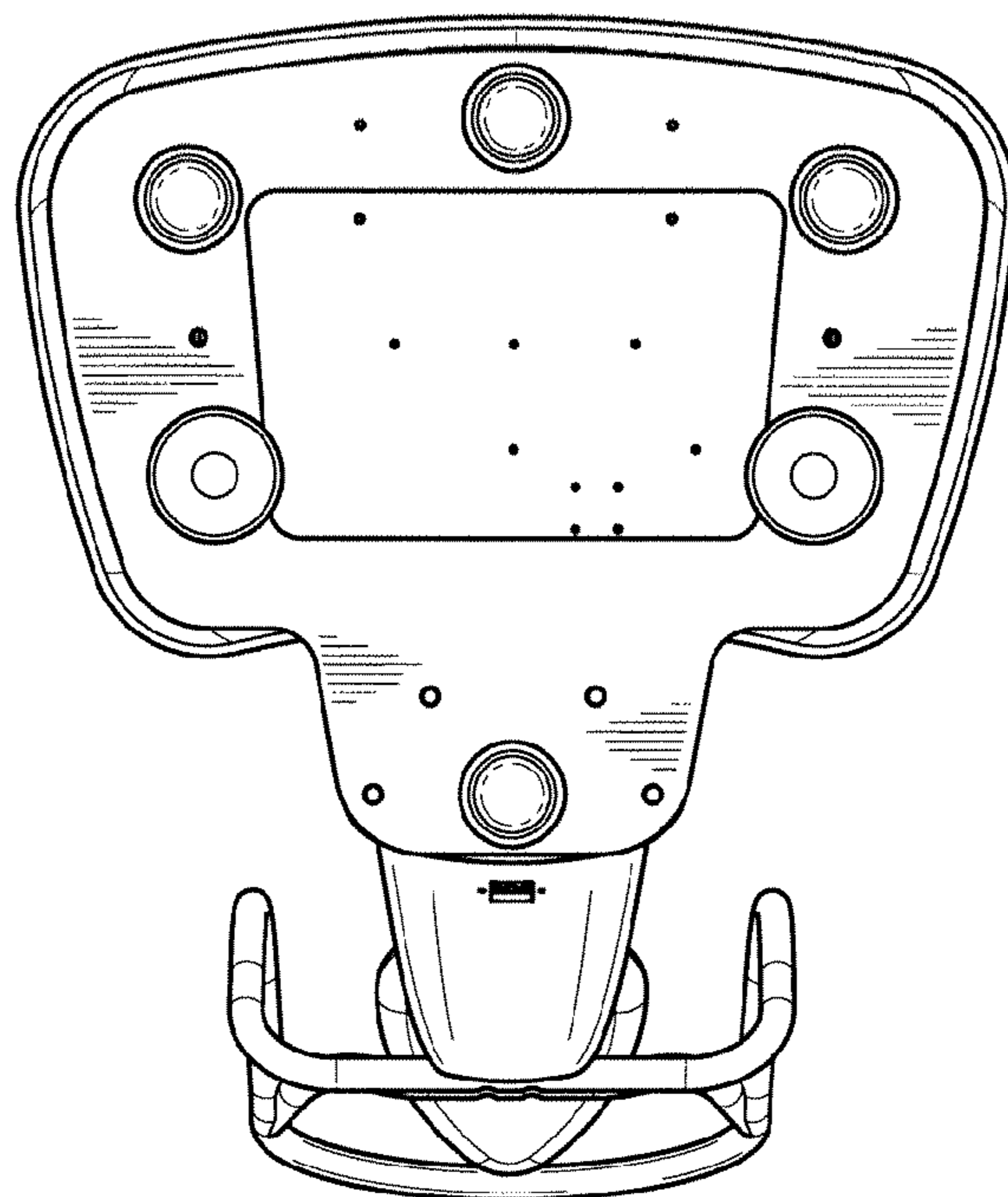

FIG. 7