



US00D602513S

(12) **United States Design Patent**
Kim et al.

(10) **Patent No.:** **US D602,513 S**
(45) **Date of Patent:** **** Oct. 20, 2009**

(54) **PROJECTOR**

(75) Inventors: **Jin-Nam Kim**, Seoul (KR); **Chol-Ho Hwang**, Suwon-Si (KR)

(73) Assignee: **Samsung Electronics Co., Ltd.**, Suwon-Si (KR)

(**) Term: **14 Years**

(21) Appl. No.: **29/322,935**

(22) Filed: **Aug. 14, 2008**

(30) **Foreign Application Priority Data**

Jun. 19, 2008 (KR) 30-2008-0026411

(51) **LOC (9) Cl.** **16-02**

(52) **U.S. Cl.** **D16/229; D16/230**

(58) **Field of Classification Search** D16/221, D16/225, 229-231, 234, 200-205, 208, 213; D21/514; D14/128; 352/34, 242-243; 353/115, 353/119, 122

See application file for complete search history.

(56) **References Cited**

U.S. PATENT DOCUMENTS

D289,769 S * 5/1987 Geissler D16/229
D367,489 S * 2/1996 Katayama D16/229
D425,925 S * 5/2000 Akaike D16/225

D491,971 S * 6/2004 Oross et al. D16/225
D498,782 S * 11/2004 Ooshima D16/235
7,059,732 B2 * 6/2006 Oross et al. 353/119
7,083,289 B2 * 8/2006 Oross et al. 353/119
7,108,382 B2 * 9/2006 Oross 353/119
7,445,342 B2 * 11/2008 Garg 353/79
2009/0086173 A1 * 4/2009 Combs et al. 353/122

* cited by examiner

Primary Examiner—Ian Simmons

Assistant Examiner—Wan Laymon

(74) *Attorney, Agent, or Firm*—Staas & Halsey LLP

(57) **CLAIM**

The ornamental design for a projector, as shown and described.

DESCRIPTION

FIG. 1 is a perspective view of a projector;
FIG. 2 is a front view of the projector of FIG. 1;
FIG. 3 is a rear view of the projector of FIG. 1;
FIG. 4 is a left-side view of the projector of FIG. 1;
FIG. 5 is a right-side view of the projector of FIG. 1;
FIG. 6 is a top plan view of the projector of FIG. 1;
FIG. 7 is a bottom plan view of the projector of FIG. 1; and,
FIG. 8 is a perspective open view of the projector of FIG. 1.

1 Claim, 5 Drawing Sheets

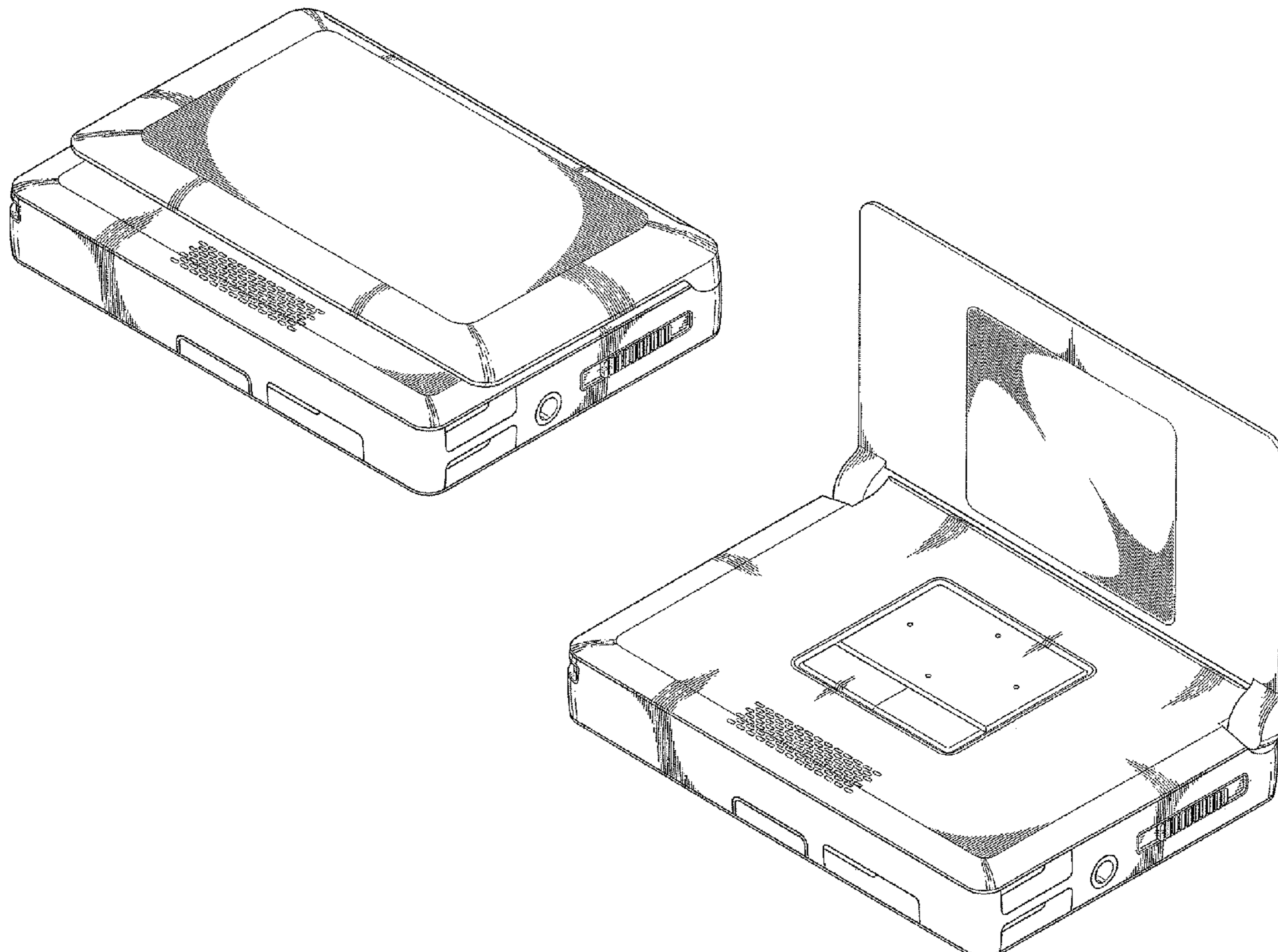

FIG. 1

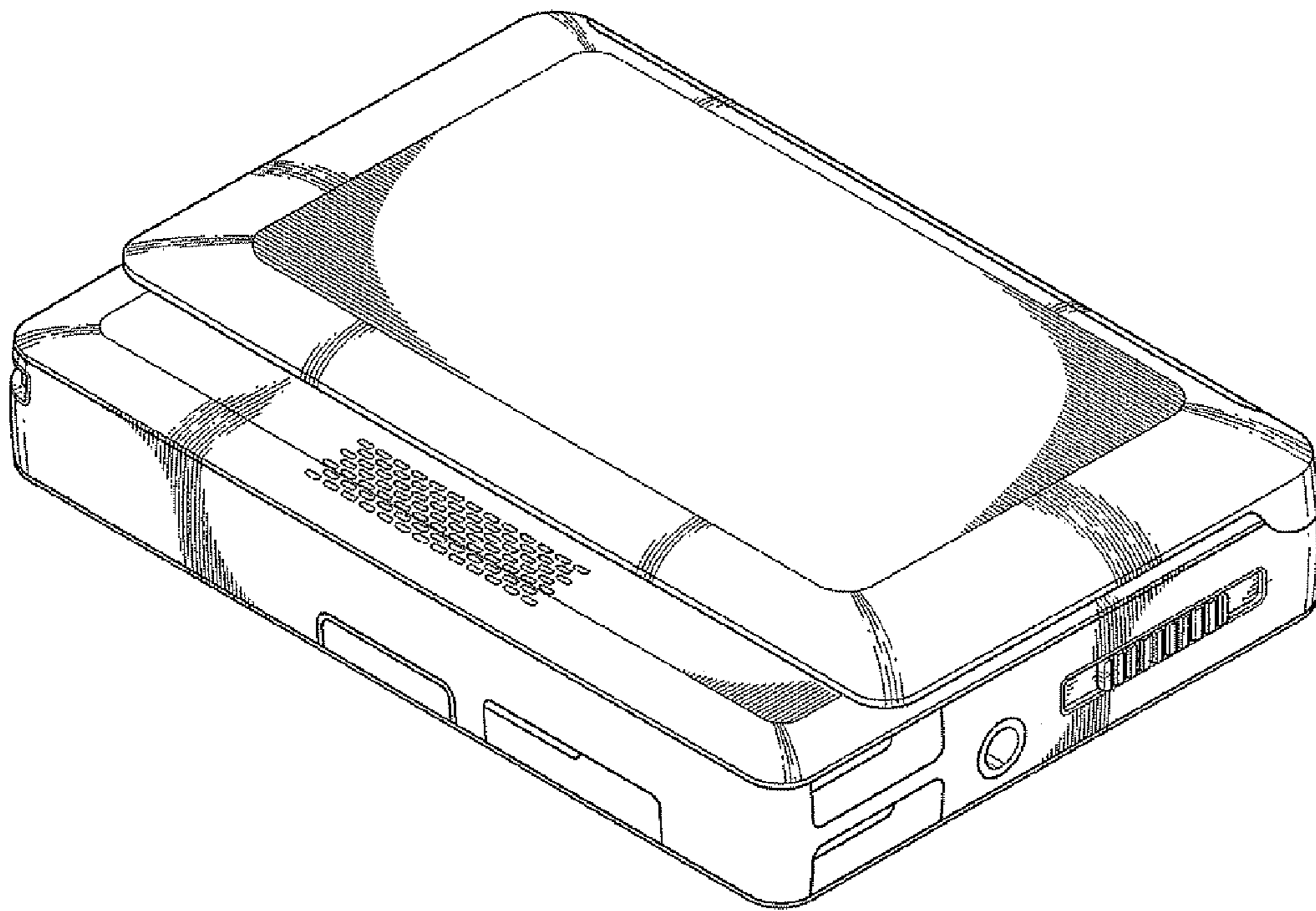

FIG. 2

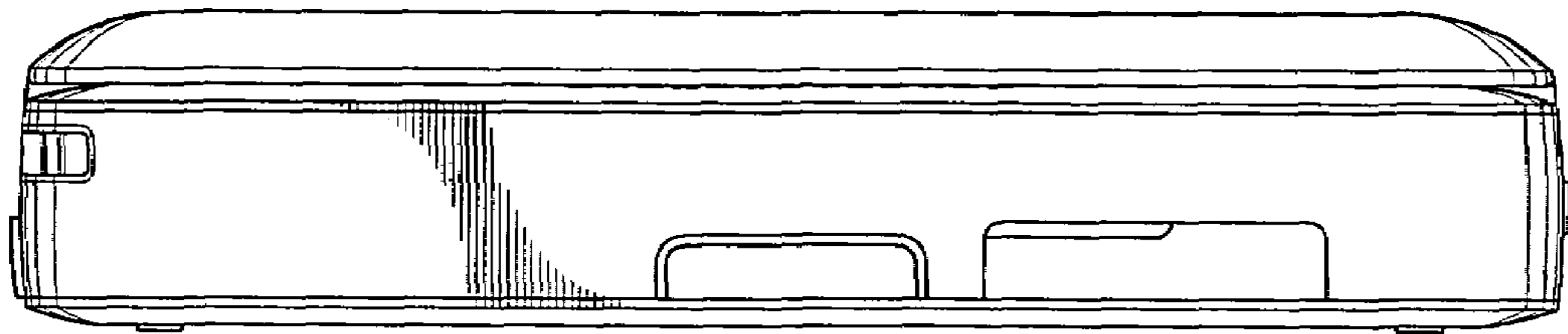

FIG. 3

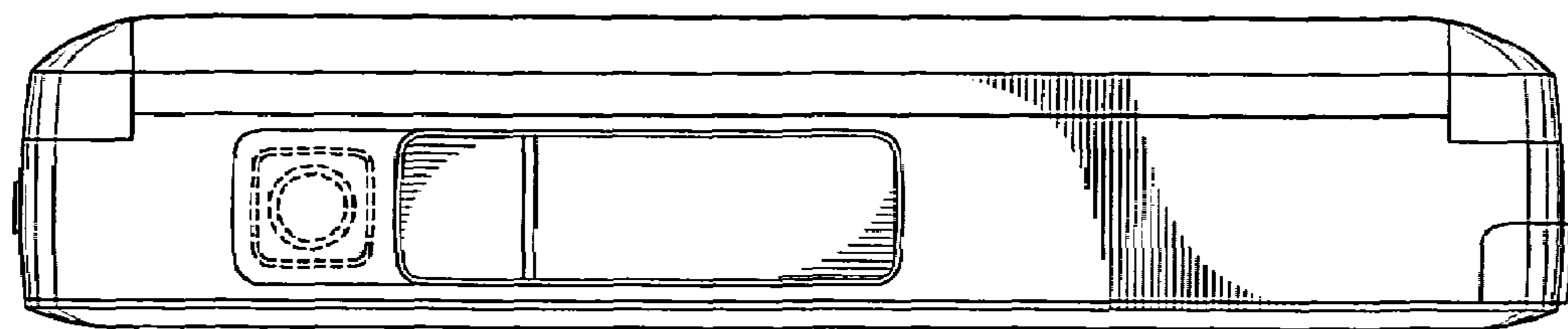

FIG. 4

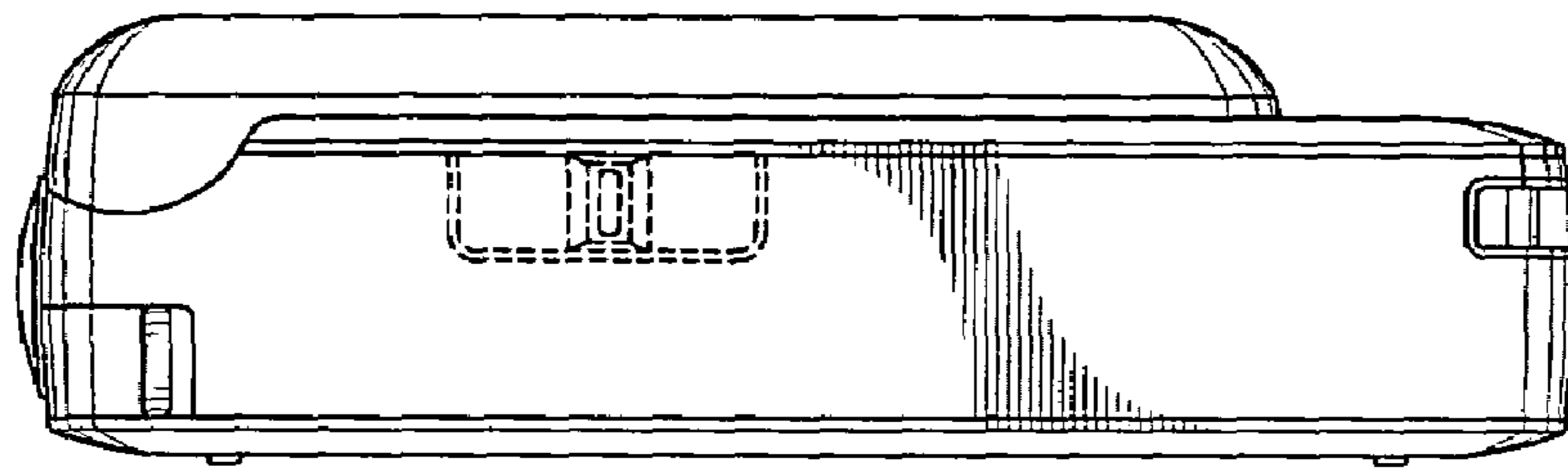

FIG. 5

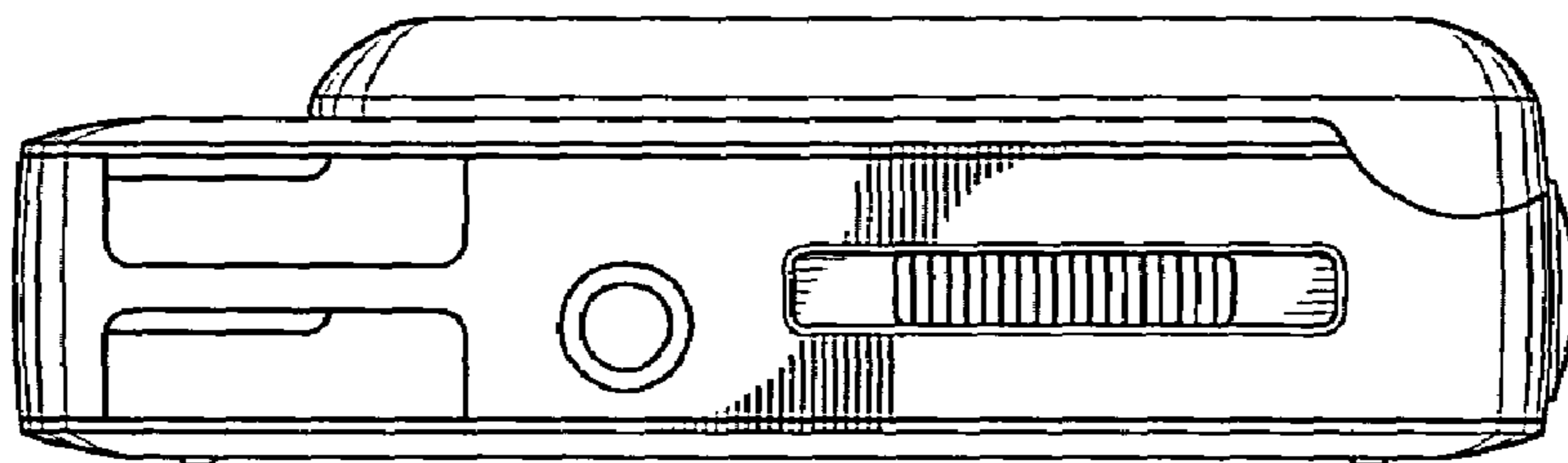

FIG. 6

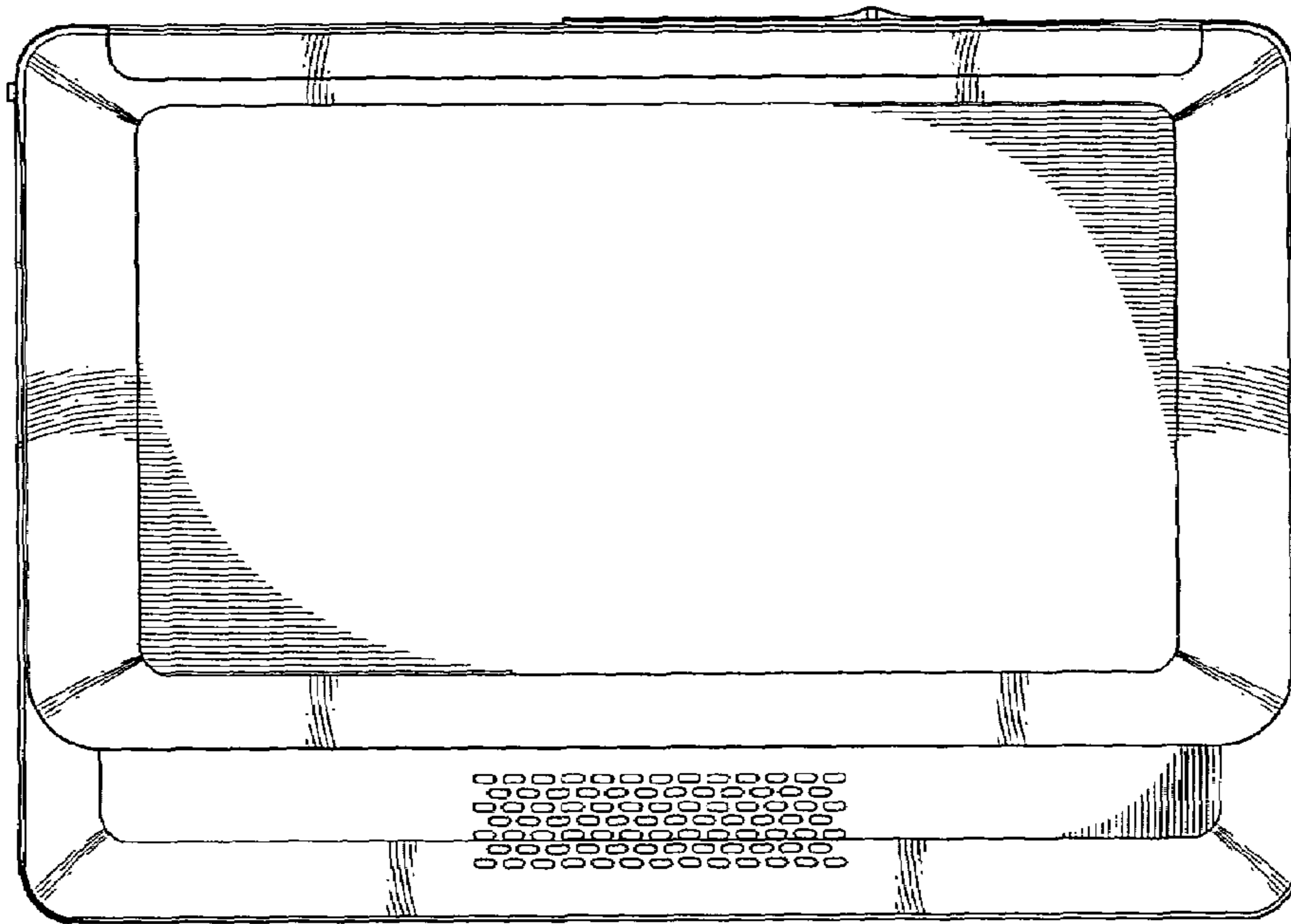

FIG. 7

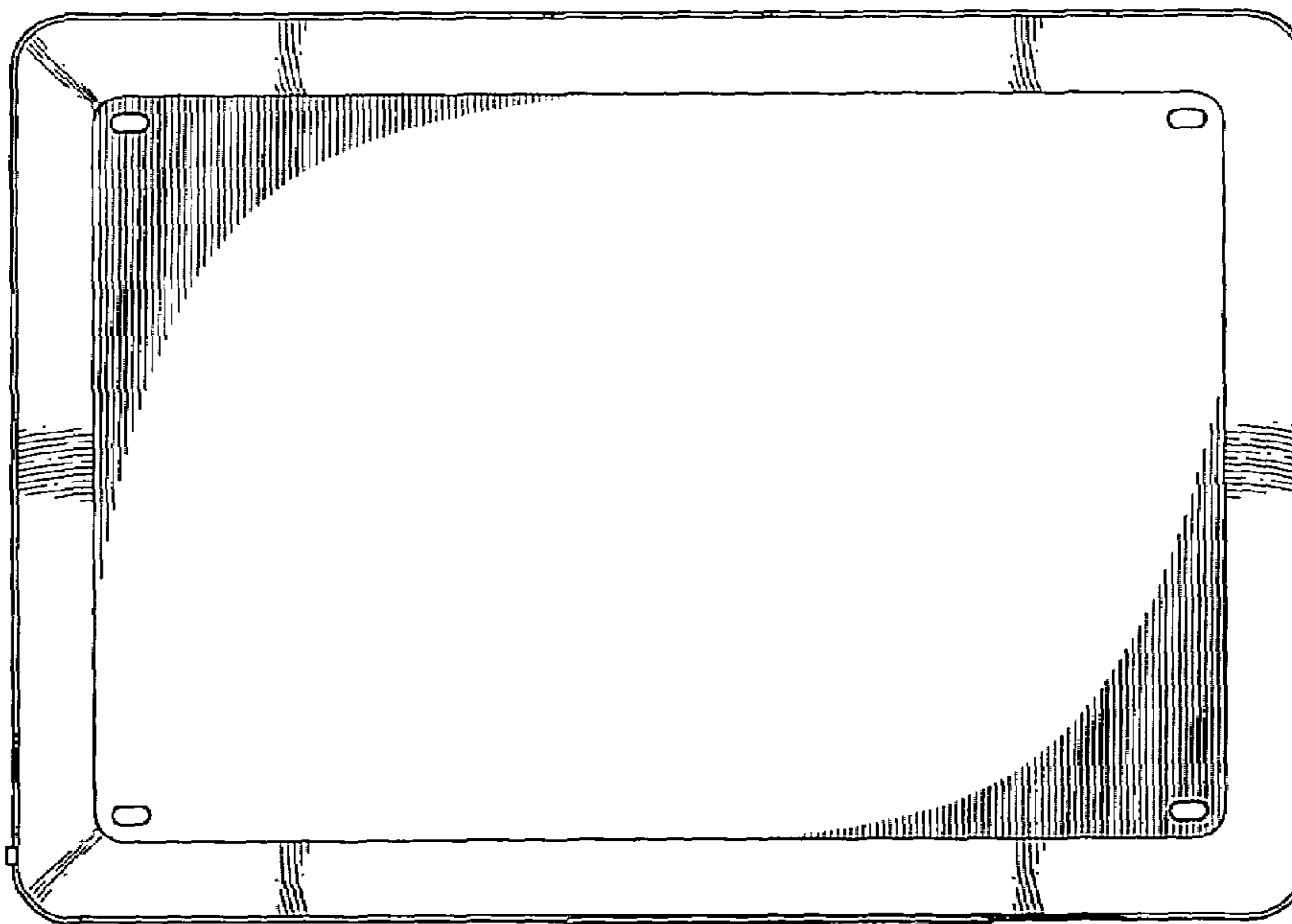

FIG. 8

