



US00D602508S

(12) **United States Design Patent**
Shimomura et al.

(10) **Patent No.:** **US D602,508 S**

(45) **Date of Patent:** **** Oct. 20, 2009**

(54) **PORTION OF A SKID STEER LOADER**

(75) Inventors: **Takashi Shimomura**, Takatsuki (JP);
Tadashi Kusunoki, Sakai (JP)

(73) Assignee: **Kubota Corporation**, Osaka (JP)

(**) Term: **14 Years**

(21) Appl. No.: **29/310,794**

(22) Filed: **Sep. 10, 2008**

(30) **Foreign Application Priority Data**

Jun. 6, 2008 (JP) 2008-014500

(51) **LOC (9) Cl.** **15-03**

(52) **U.S. Cl.** **D15/32**

(58) **Field of Classification Search** D15/10,
D15/22-26, 28; 180/89.1, 89.12, 900; 37/118 R;
414/685, 686, 680

See application file for complete search history.

(56) **References Cited**

U.S. PATENT DOCUMENTS

D224,588 S	8/1972	Bauer	
D231,482 S	4/1974	Bauer	
D251,088 S	2/1979	Johnson et al.	
D317,926 S	7/1991	Lynnes et al.	
D322,792 S *	12/1991	Park	D15/25
5,169,278 A *	12/1992	Hoechst et al.	414/685
5,542,814 A *	8/1996	Ashcroft et al.	414/685
5,609,464 A *	3/1997	Moffitt et al.	414/685
D407,415 S	3/1999	Flatau et al.	
D419,568 S	1/2000	Baig et al.	
6,171,050 B1 *	1/2001	Johnson	414/685
D450,718 S	11/2001	Muraro	
D469,448 S *	1/2003	Bares et al.	D15/32
D520,525 S	5/2006	Enmeiji et al.	
D528,569 S	9/2006	Nilsson	
7,147,425 B2 *	12/2006	Holt	414/694
D538,829 S *	3/2007	Nilsson	D15/28
7,264,435 B2 *	9/2007	Layko et al.	414/686

* cited by examiner

Primary Examiner—Ian Simmons

Assistant Examiner—Mark A Goodwin

(74) *Attorney, Agent, or Firm*—The Webb Law Firm

(57) **CLAIM**

The ornamental design for a portion of a skid steer loader, as shown and described.

DESCRIPTION

FIG. 1 is a right side view of a portion of a skid steer loader showing our new design. The part of the photograph shown in coarse dot pattern and outlined in dashed lines illustrates a portion of the skid steer loader that forms no part of the claimed design;

FIG. 2 is a left side view thereof. The part of the photograph shown in coarse dot pattern and outlined in dashed lines illustrates a portion of the skid steer loader that forms no part of the claimed design;

FIG. 3 is a front side view thereof. The part of the photograph shown in coarse dot pattern and outlined in dashed lines illustrates a portion of the skid steer loader that forms no part of the claimed design;

FIG. 4 is a top plan view thereof. The part of the photograph shown in coarse dot pattern and outlined in dashed lines illustrates a portion of the skid steer loader that forms no part of the claimed design.

FIG. 5 is a right front perspective view thereof. The part of the photograph shown in coarse dot pattern and outlined in dashed lines illustrates a portion of the skid steer loader that forms no part of the claimed design. The left front perspective view of the claimed design, although not illustrated, is a mirror image of the right front perspective view shown in FIG. 5; and,

FIG. 6 is a right rear perspective view thereof. The part of the photograph shown in coarse dot pattern and outlined in dashed lines illustrates a portion of the skid steer loader that forms no part of the claimed design. The left rear perspective view of the claimed design, although not illustrated, is a mirror image of the right rear perspective view shown in FIG. 6.

1 Claim, 6 Drawing Sheets

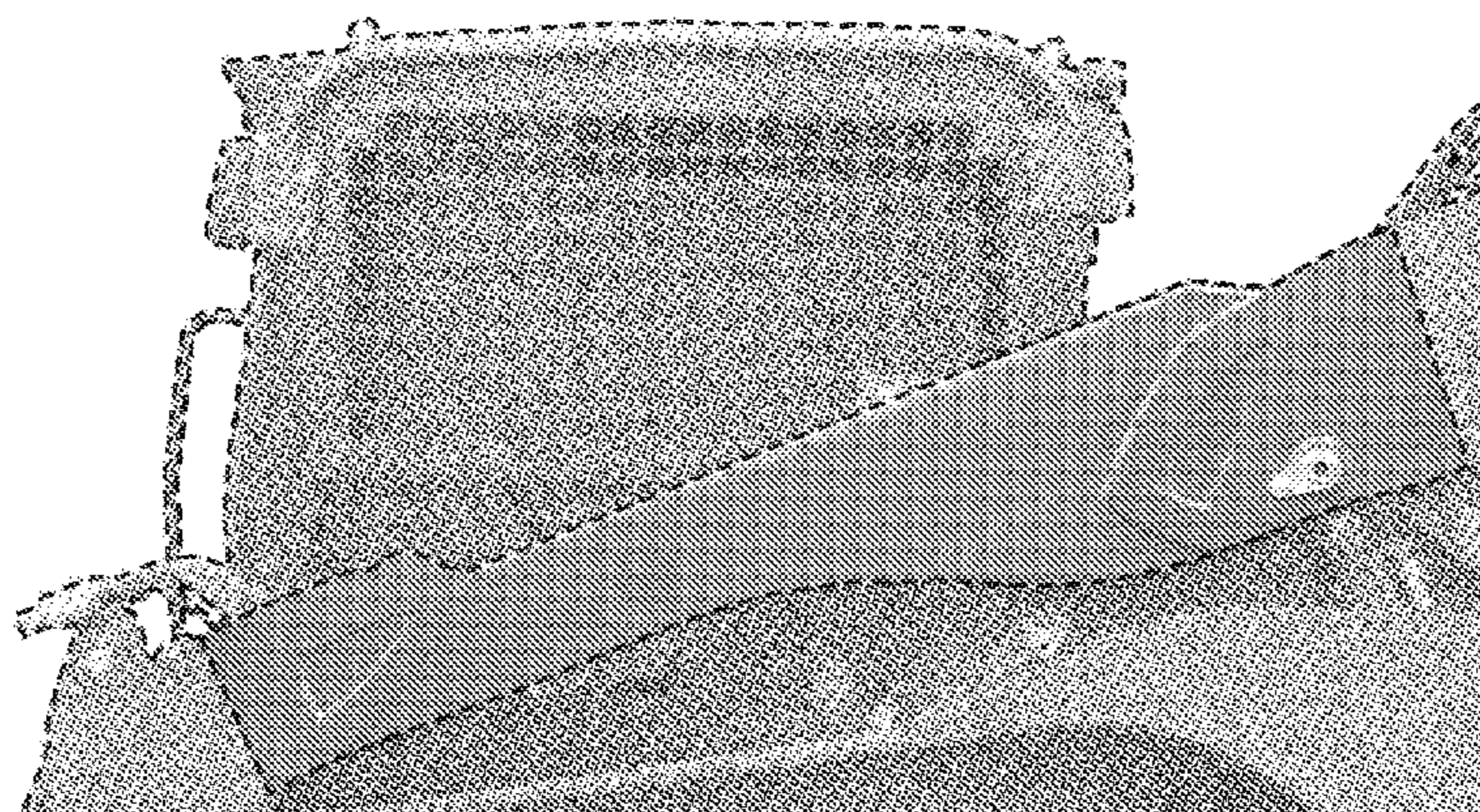

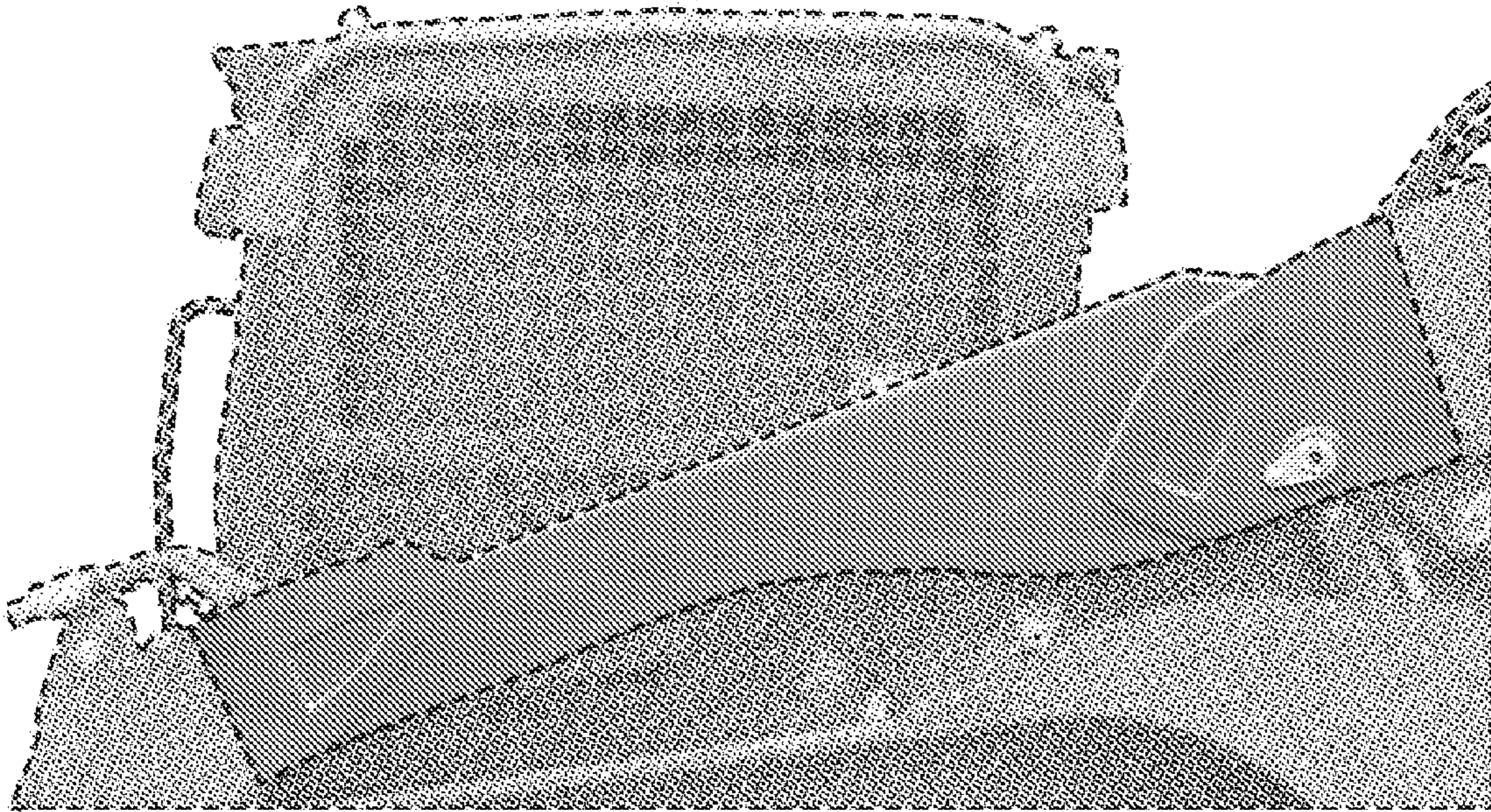

FIG. 1

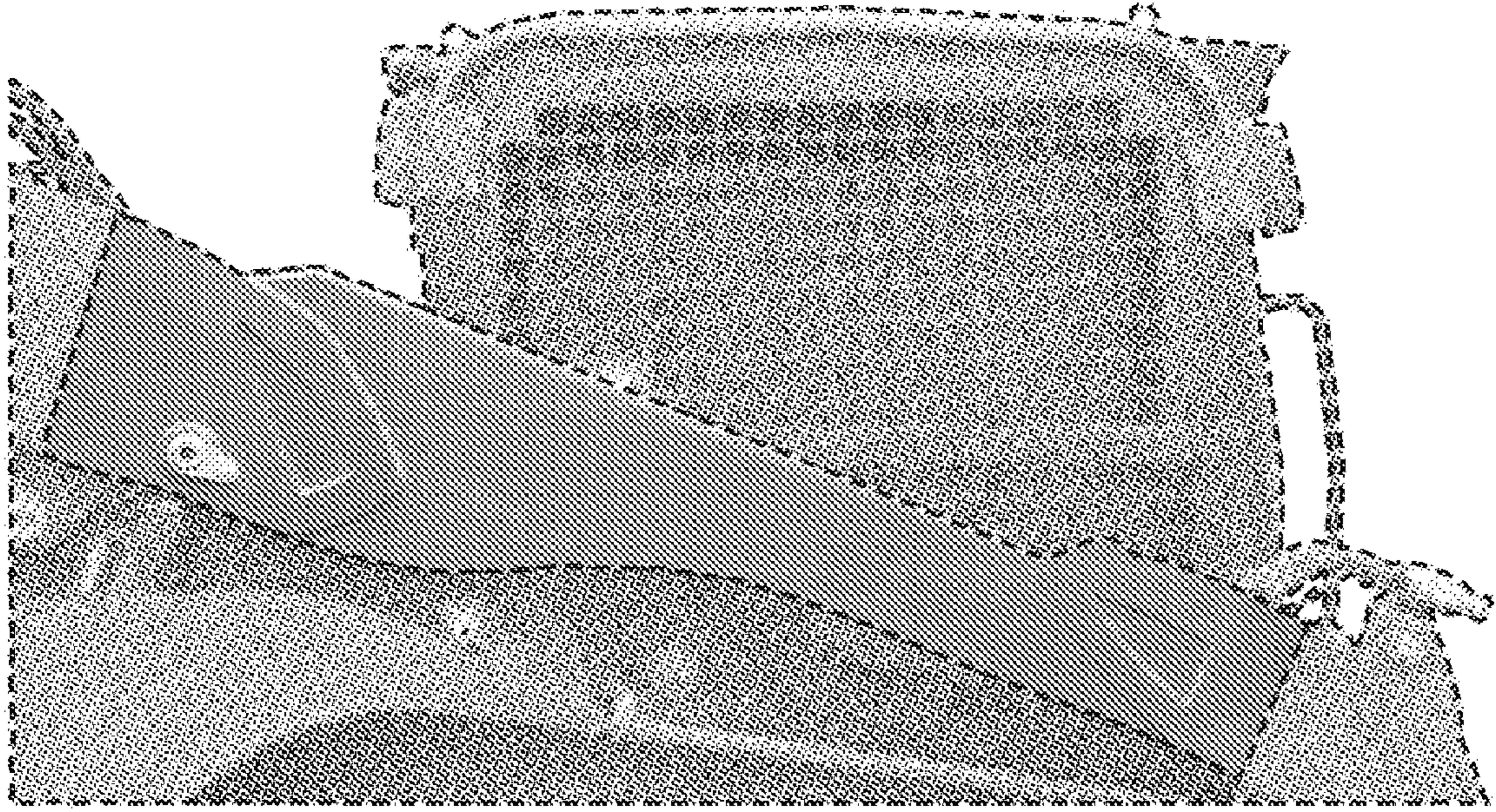

FIG. 2

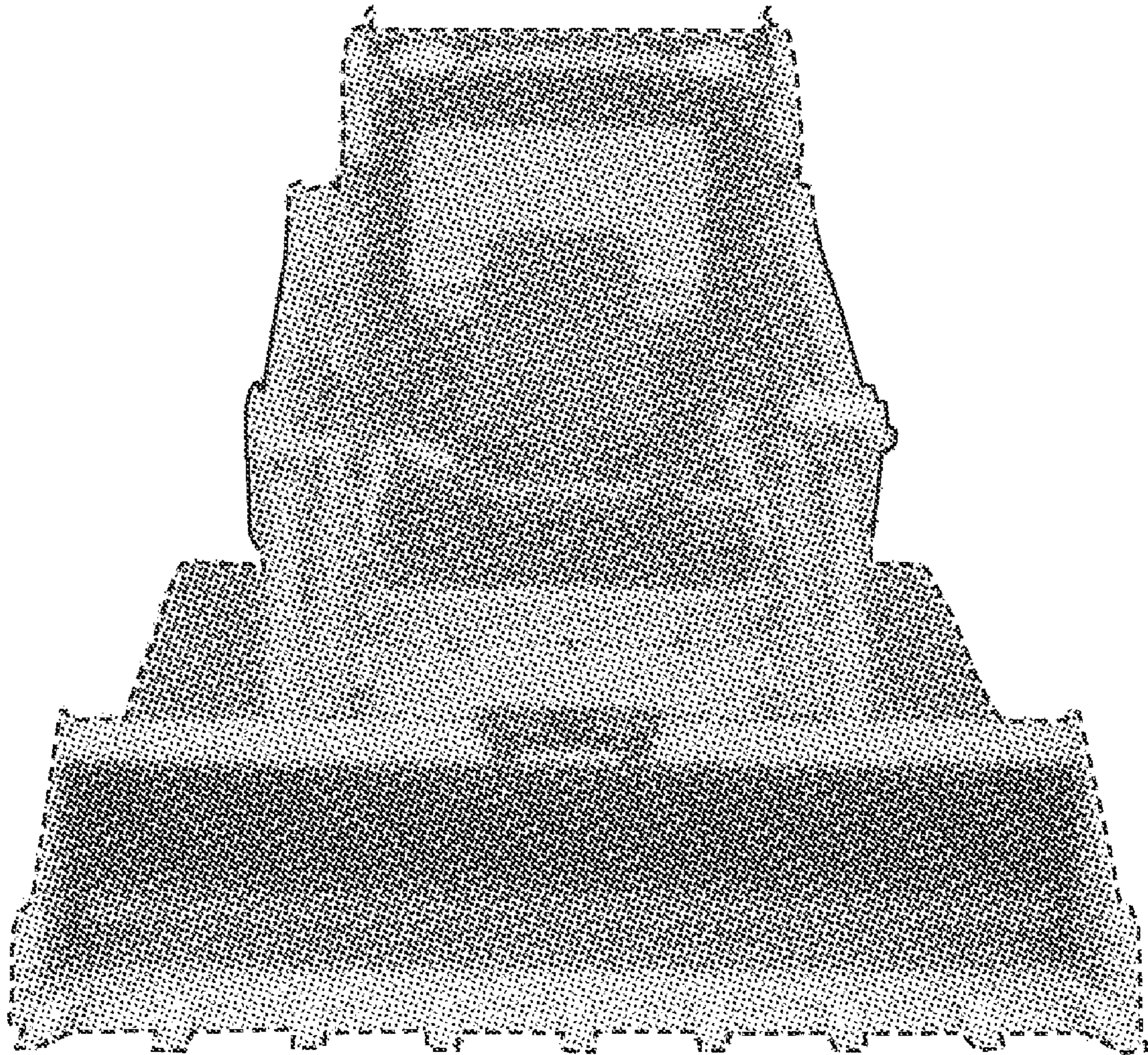

FIG. 3

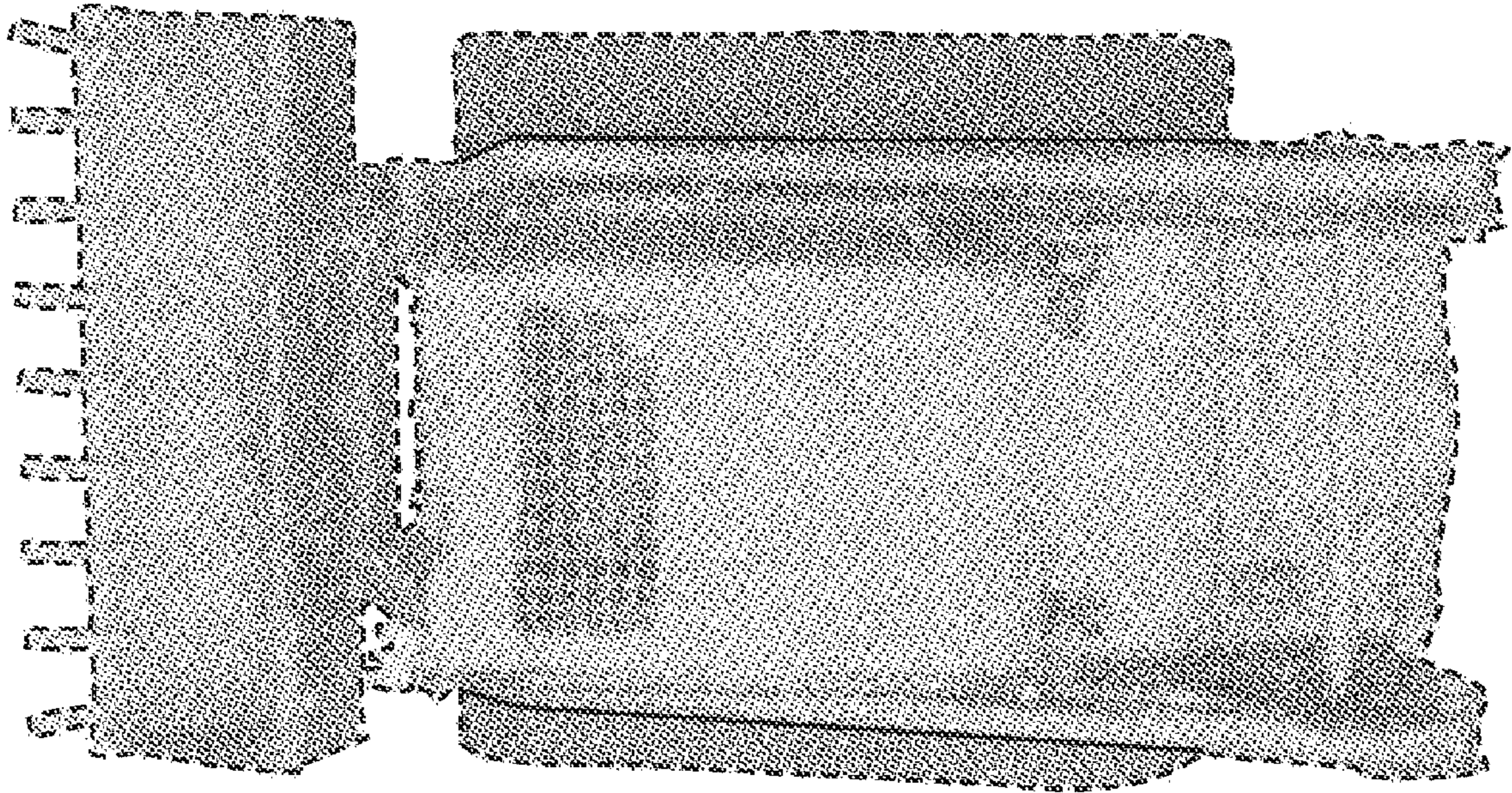

FIG. 4

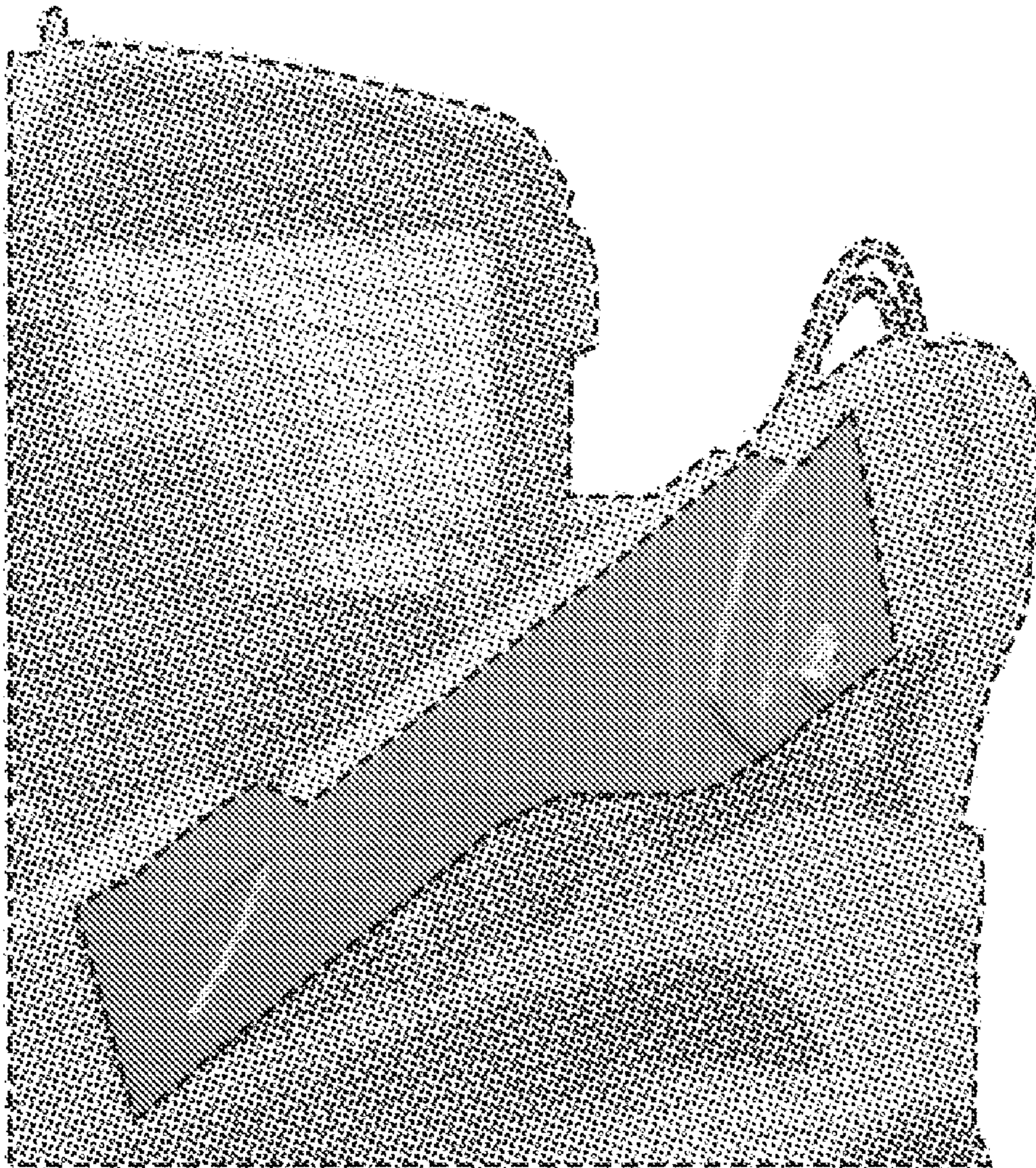

FIG. 5

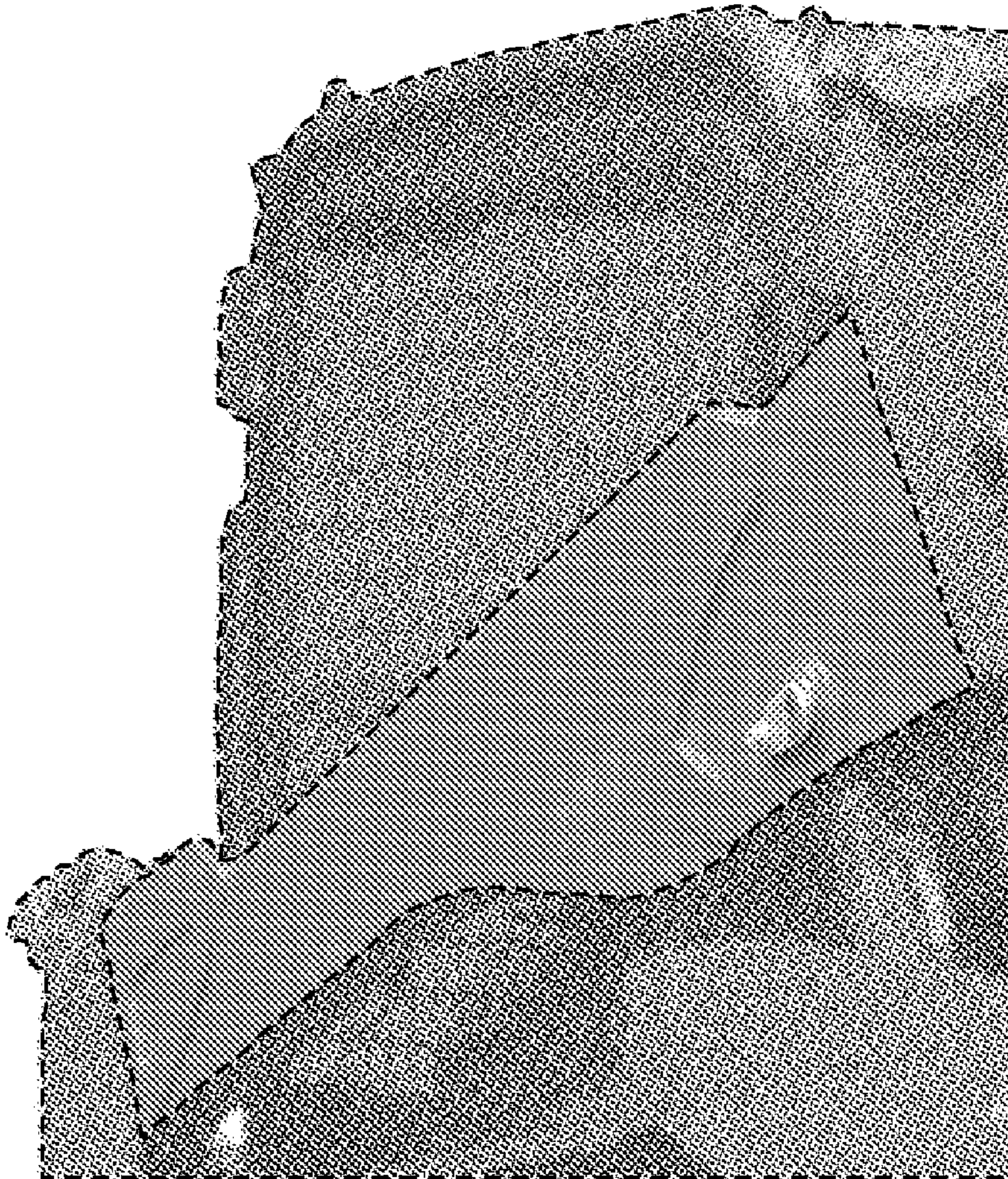

FIG. 6