



US00D602450S

(12) **United States Design Patent**  
**Edmond et al.**

(10) **Patent No.:** **US D602,450 S**

(45) **Date of Patent:** **\*\* Oct. 20, 2009**

(54) **LED CHIP**

TW D109667 3/1993  
TW D112798 8/1994

(75) Inventors: **John Edmond**, Cary, NC (US); **James Ibbetson**, Santa Barbara, CA (US); **Michael John Bergmann**, Chapel Hill, NC (US); **Amber Christine Salter**, Durham, NC (US); **David Todd Emerson**, Chapel Hill, NC (US); **Ashay Chitnis**, Goleta, CA (US); **Bernd P. Keller**, Santa Barbara, CA (US); **Kevin Haberern**, Cary, NC (US)

**OTHER PUBLICATIONS**

Taiwanese Office Action and English Translation (9 pages) corresponding to Taiwanese Patent Application No. 097301339; Mailing Date: Dec. 30, 2008.

*Primary Examiner*—Selina Sikder  
(74) *Attorney, Agent, or Firm*—Myers Bigel Sibley & Sajovec

(73) Assignee: **Cree, Inc.**, Durham, NC (US)

(57) **CLAIM**

(\*\*) Term: **14 Years**

The ornamental design for an LED chip, as shown and described.

(21) Appl. No.: **29/327,786**

(22) Filed: **Nov. 13, 2008**

**DESCRIPTION**

**Related U.S. Application Data**

(62) Division of application No. 29/284,431, filed on Sep. 7, 2007, now Pat. No. Des. 582,866.

(51) **LOC (9) Cl.** ..... **13-03**

(52) **U.S. Cl.** ..... **D13/180**

(58) **Field of Classification Search** ..... D13/180;  
D26/2; 257/79, 80, 81, 88, 89, 95, 98, 99,  
257/100; 313/483, 498, 500; 362/555, 800  
See application file for complete search history.

FIG. 1 is a top perspective view of a first embodiment of the LED chip showing our design;  
FIG. 2 is a top view thereof;  
FIG. 3 is a first side view thereof;  
FIG. 4 is a bottom view thereof;  
FIG. 5 is a different side view thereof;  
FIG. 6 is an end view thereof; and  
FIG. 7 is an opposing end view thereof.  
FIG. 8 is a top perspective view of a second embodiment of the LED chip showing our design;  
FIG. 9 is a top view thereof;  
FIG. 10 is a first side view thereof;  
FIG. 11 is a bottom view thereof;  
FIG. 12 is a different side view thereof;  
FIG. 13 is an end view thereof; and,  
FIG. 14 is an opposing end view thereof.

(56) **References Cited**

**U.S. PATENT DOCUMENTS**

6,097,040 A 8/2000 Morimoto et al.  
6,255,129 B1 7/2001 Lin  
6,383,835 B1\* 5/2002 Hata et al. .... 438/65  
6,498,592 B1\* 12/2002 Matthies ..... 345/1.1

(Continued)

**FOREIGN PATENT DOCUMENTS**

JP D1233259 3/2005  
JP D1294312 2/2007  
JP D1300883 5/2007

The broken lines showing portions of the LED chip is for illustrative purposes only and form no part of the claimed design.

**1 Claim, 4 Drawing Sheets**

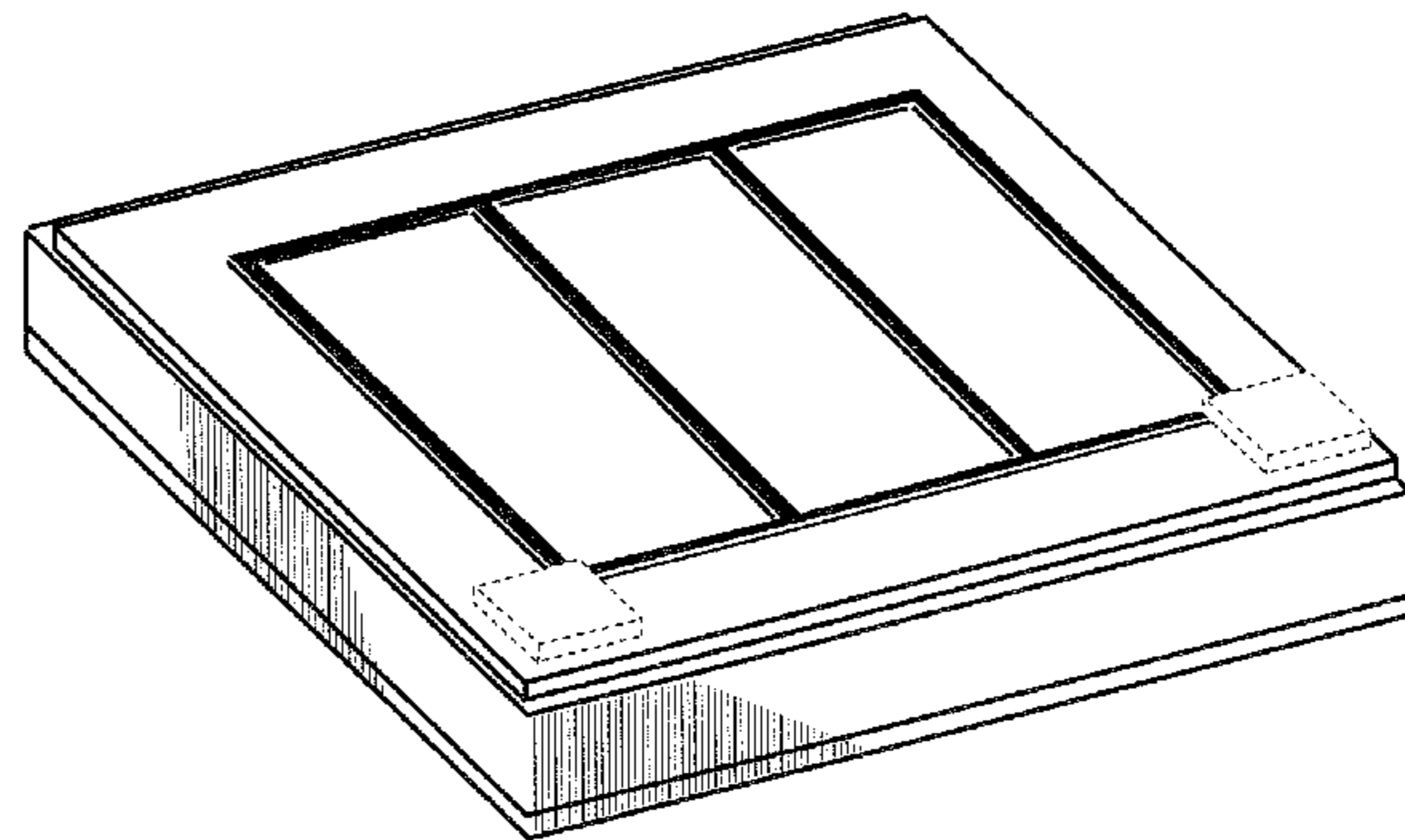
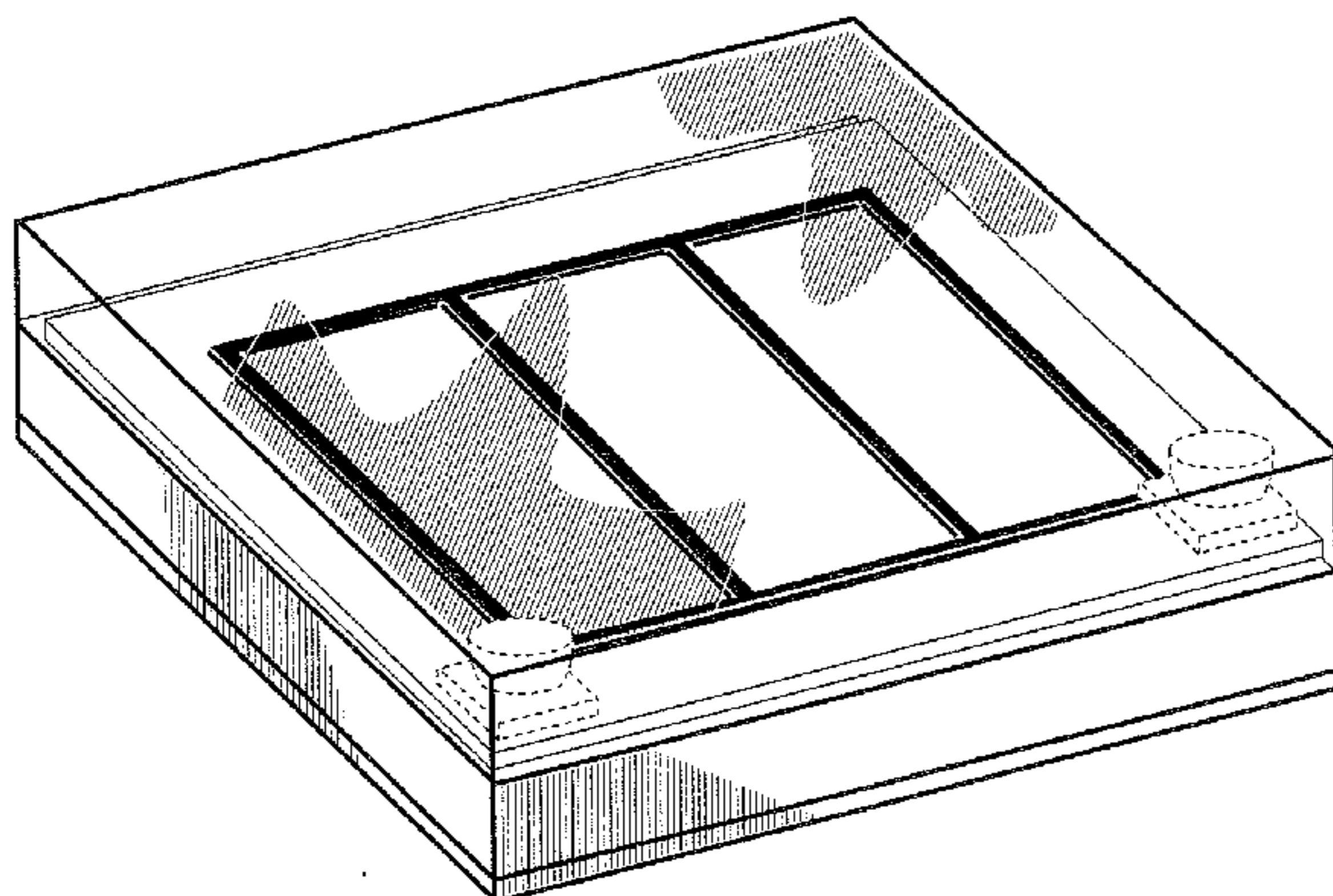

# US D602,450 S

Page 2

## U.S. PATENT DOCUMENTS

6,518,598	B1	2/2003	Chen	
6,713,868	B2 *	3/2004	Ueno	257/730
6,847,052	B2	1/2005	Fan et al.	
6,870,519	B2 *	3/2005	Sundahl	345/1.3
D521,952	S	5/2006	Yamada et al.	
D522,466	S	6/2006	Sumitani	
7,289,089	B2 *	10/2007	Iwafuchi	345/82
D566,056	S *	4/2008	Edmond et al.	D13/180
D566,057	S *	4/2008	Edmond et al.	D13/180
D566,665	S *	4/2008	Liao et al.	D13/180
D582,865	S *	12/2008	Edmond et al.	D13/180
D582,866	S *	12/2008	Edmond et al.	D13/180
D583,338	S *	12/2008	Edmond et al.	D13/180
2003/0222263	A1 *	12/2003	Choi	257/79
2005/0023539	A1	2/2005	Fujiwara et al.	
2005/0067624	A1	3/2005	Steigerwald et al.	
2006/0049422	A1	3/2006	Shoji	
2006/0131600	A1 *	6/2006	Nakaoka et al.	257/99
2006/0151800	A1	7/2006	Keong et al.	
2006/0226437	A1	10/2006	Fujita et al.	
2007/0075323	A1 *	4/2007	Kanazawa et al.	257/98
2007/0085089	A1	4/2007	Hsu	
2007/0138585	A1	6/2007	Hsin et al.	

\* cited by examiner

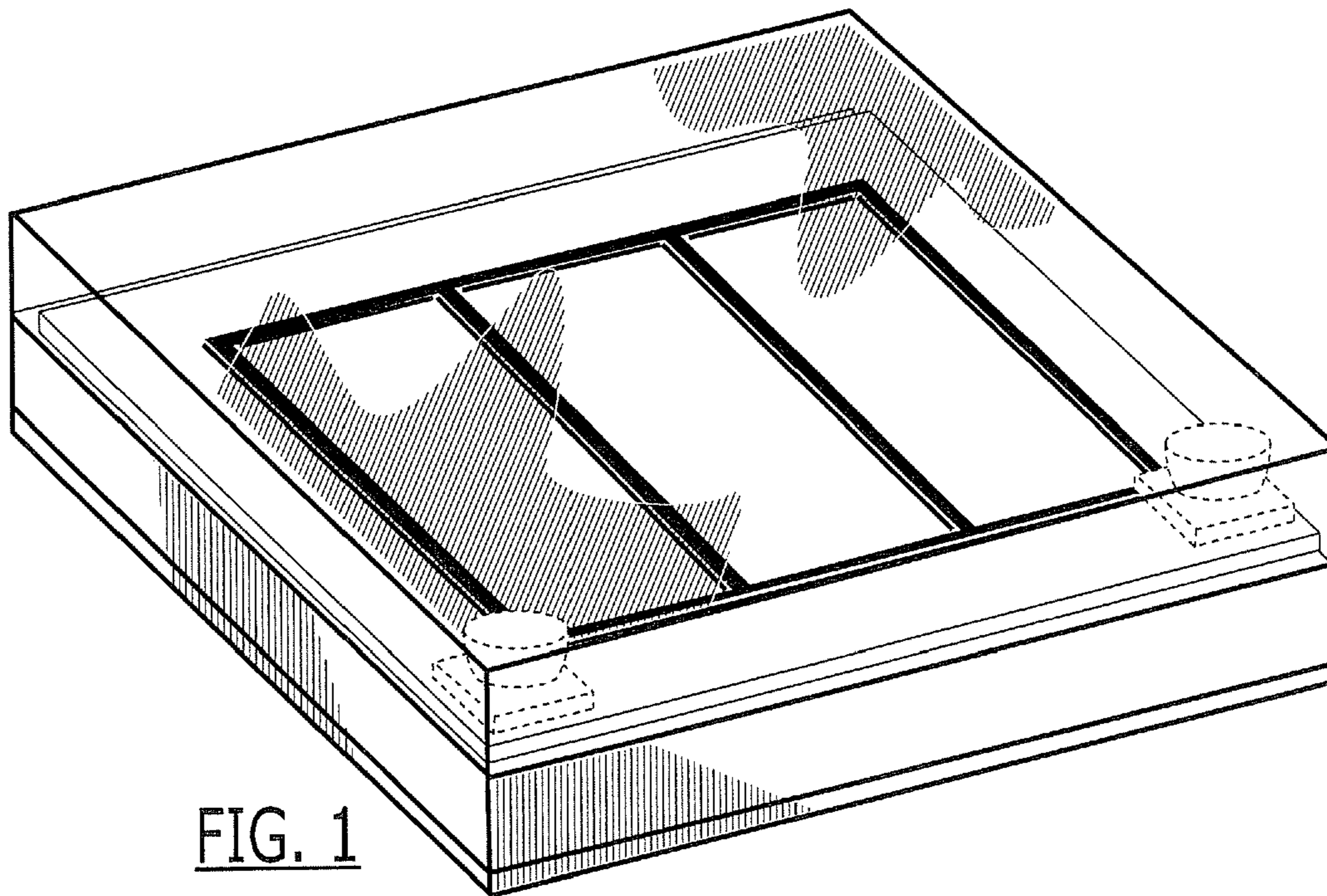

FIG. 1

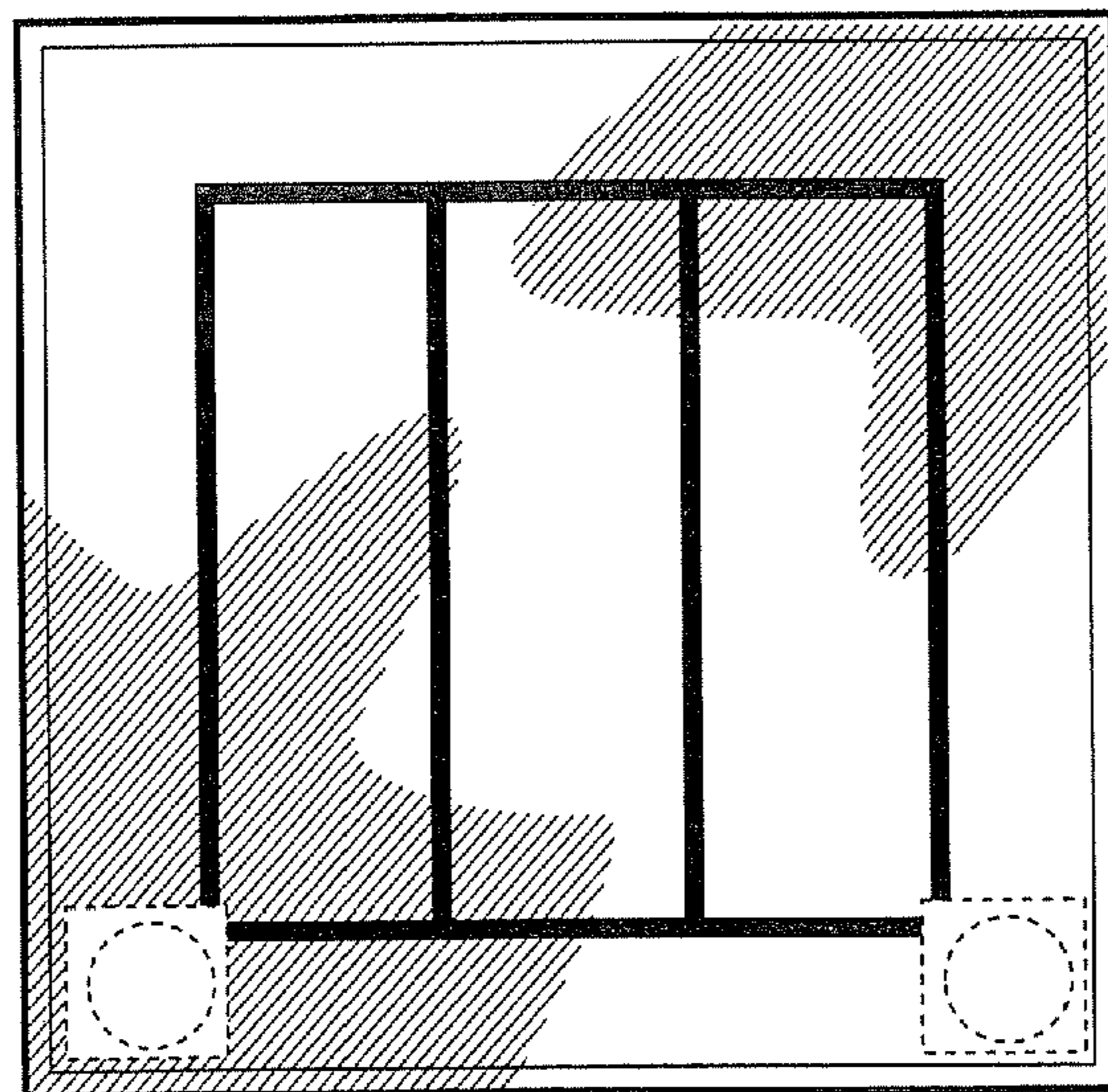

FIG. 2

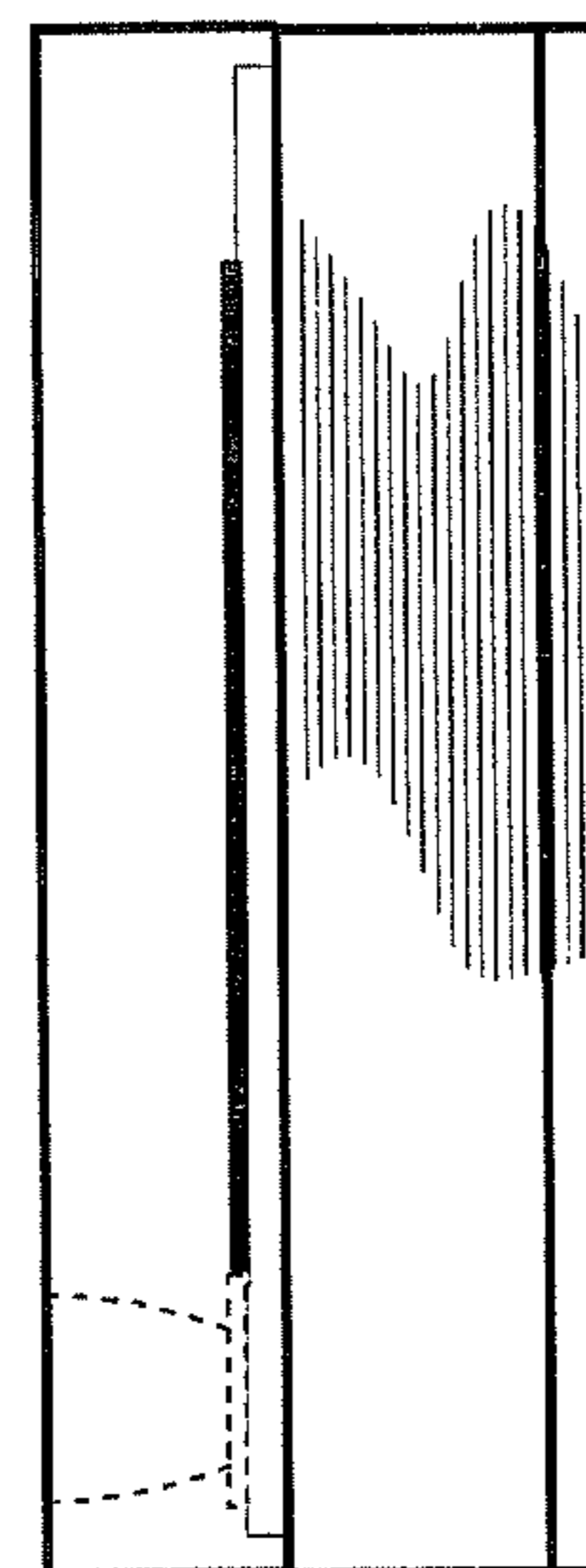

FIG. 3

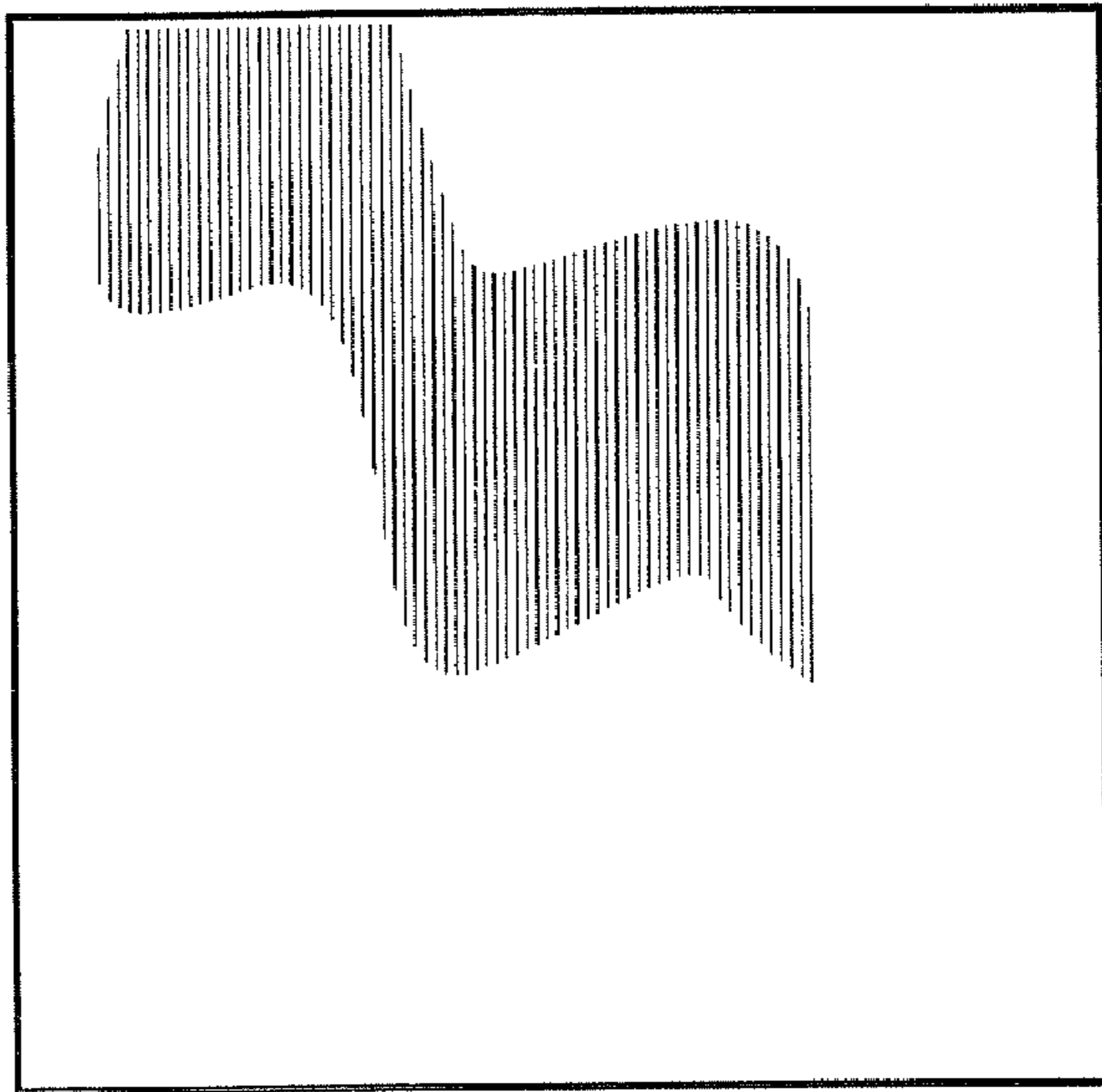

FIG. 4

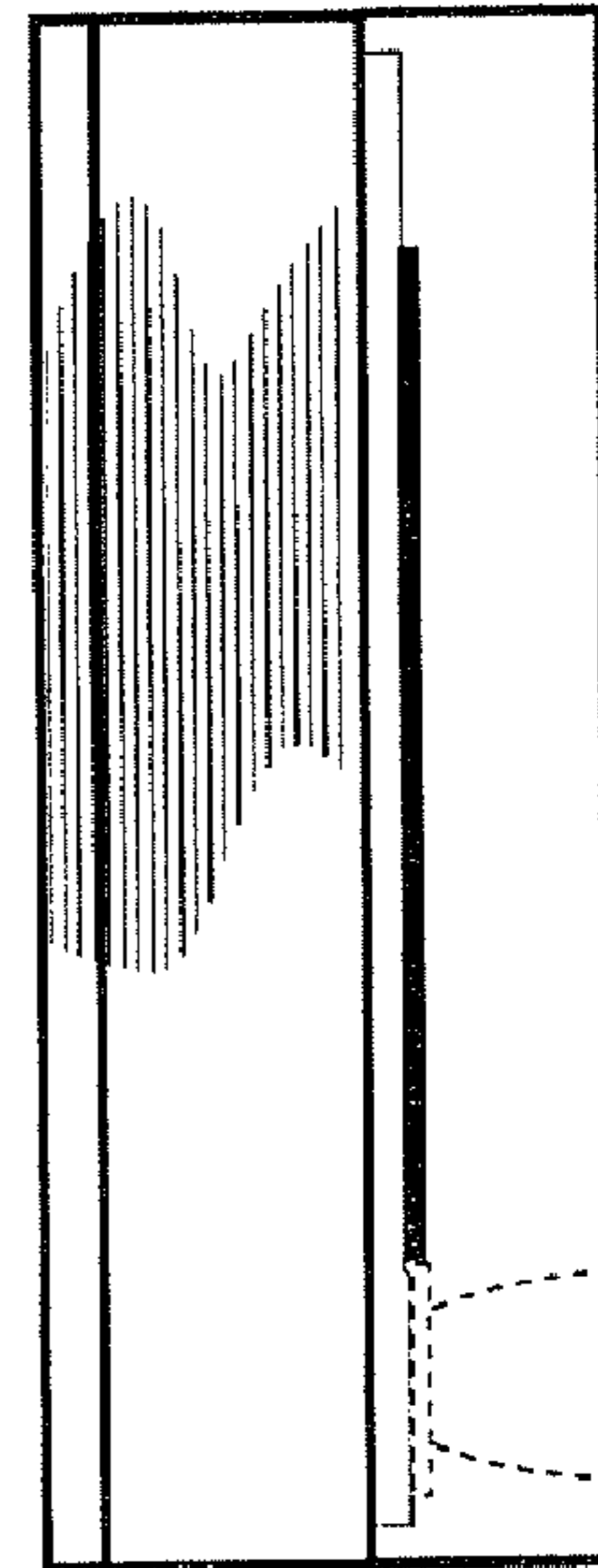

FIG. 5

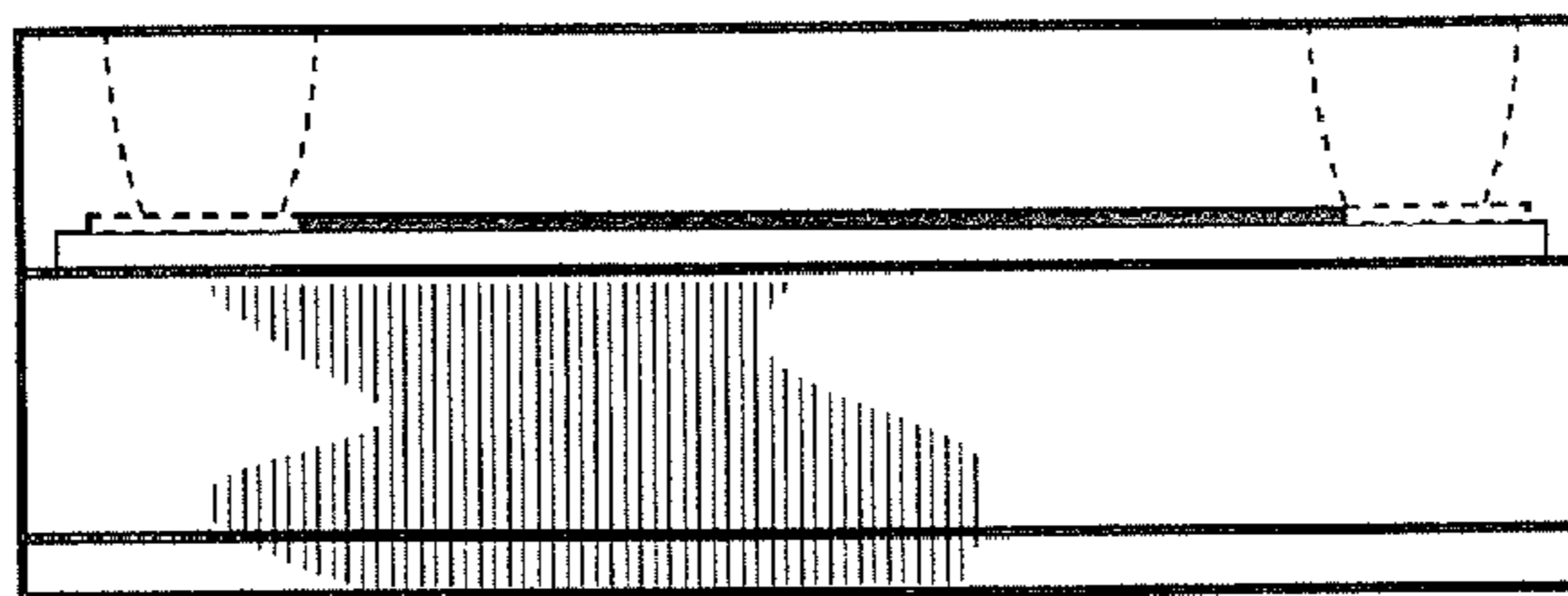

FIG. 6

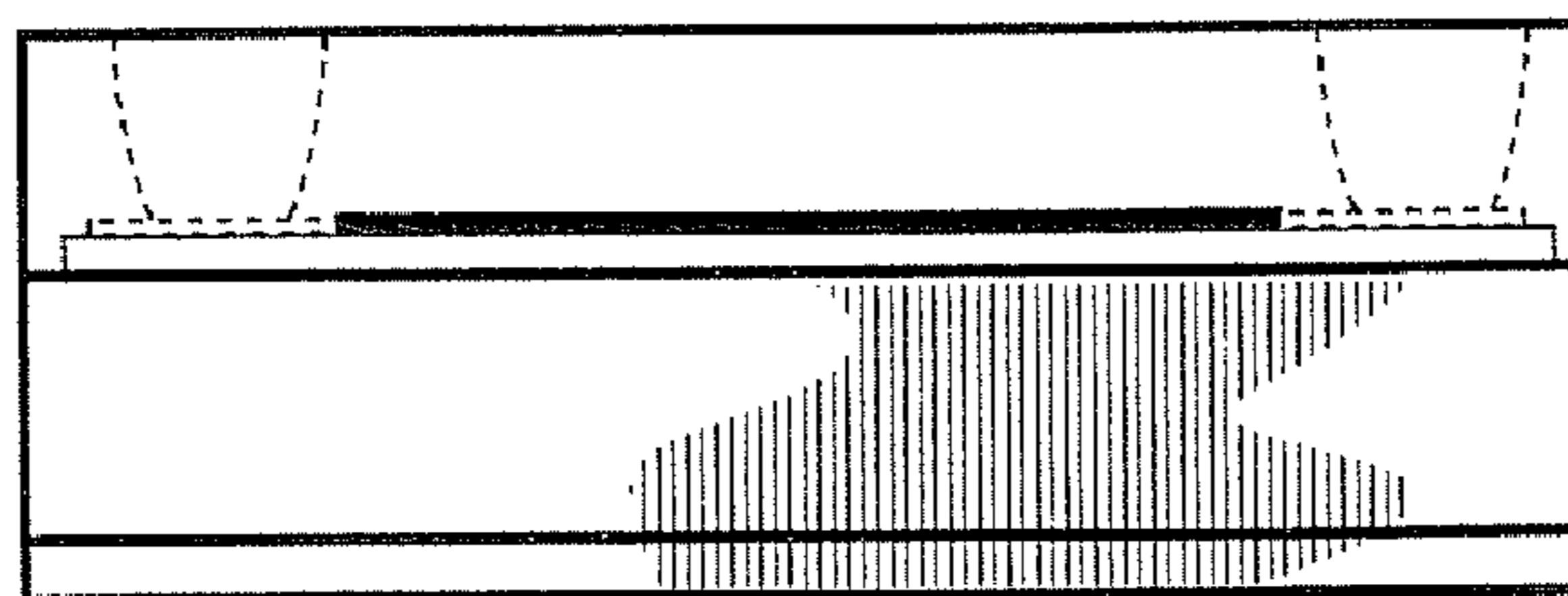

FIG. 7

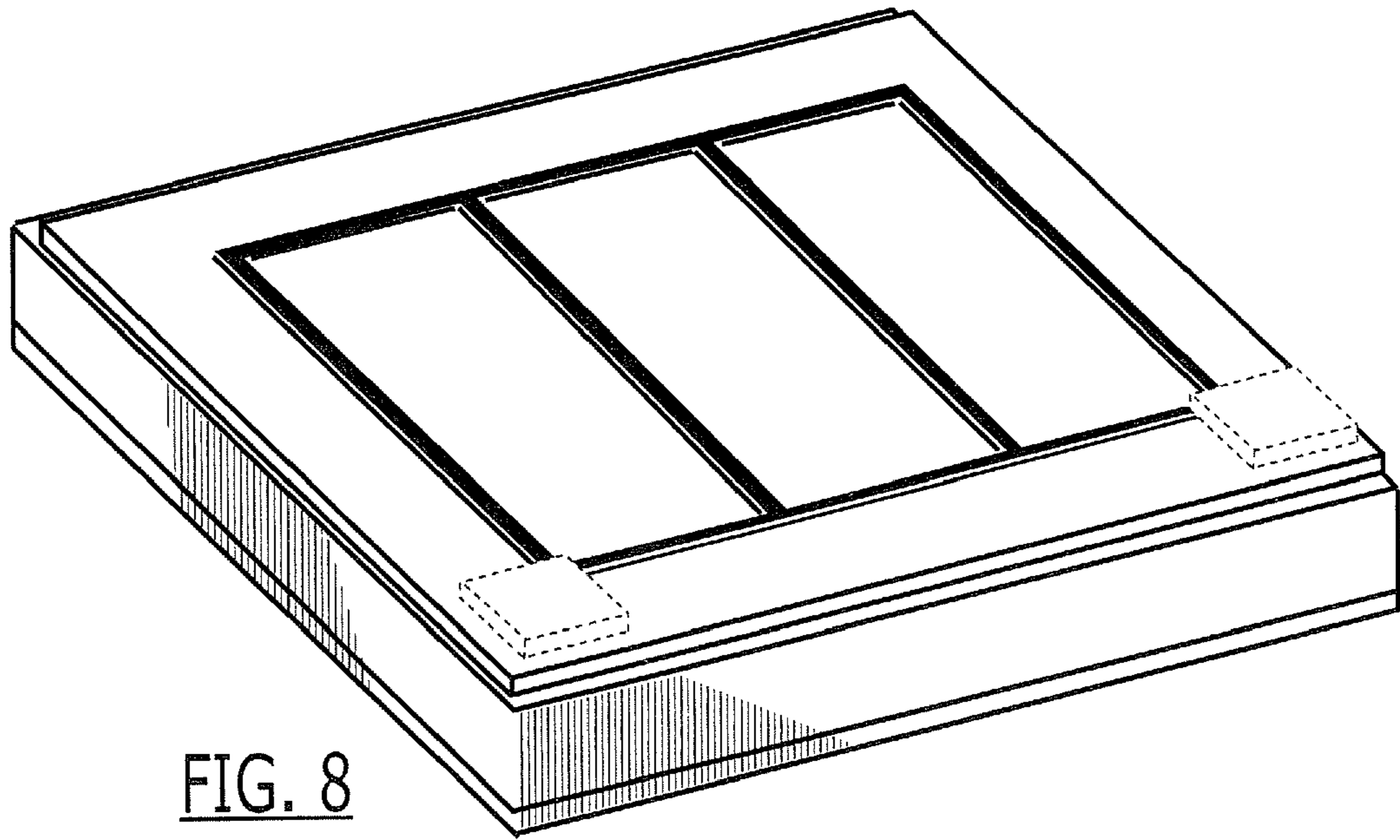

FIG. 8

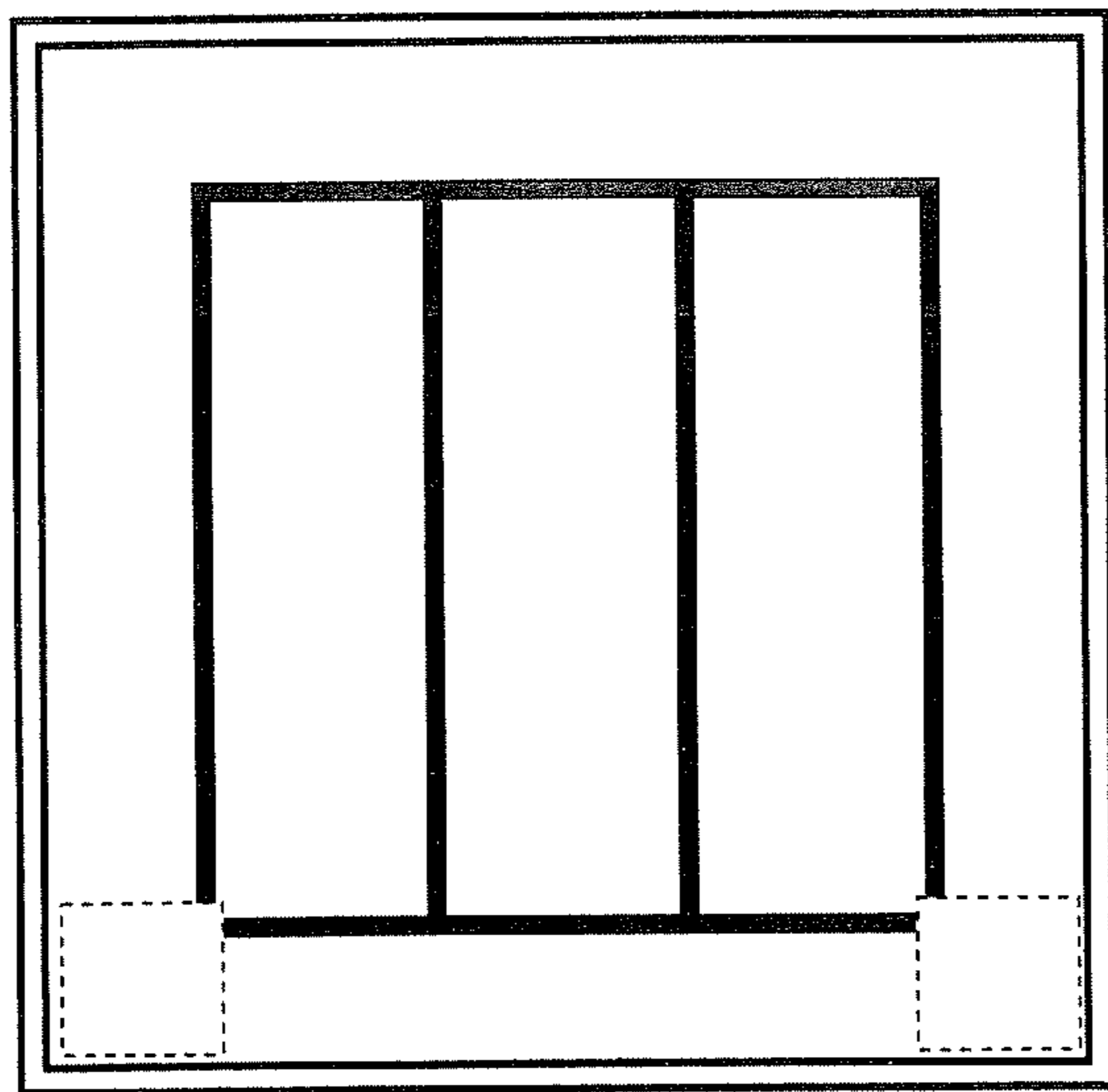

FIG. 9

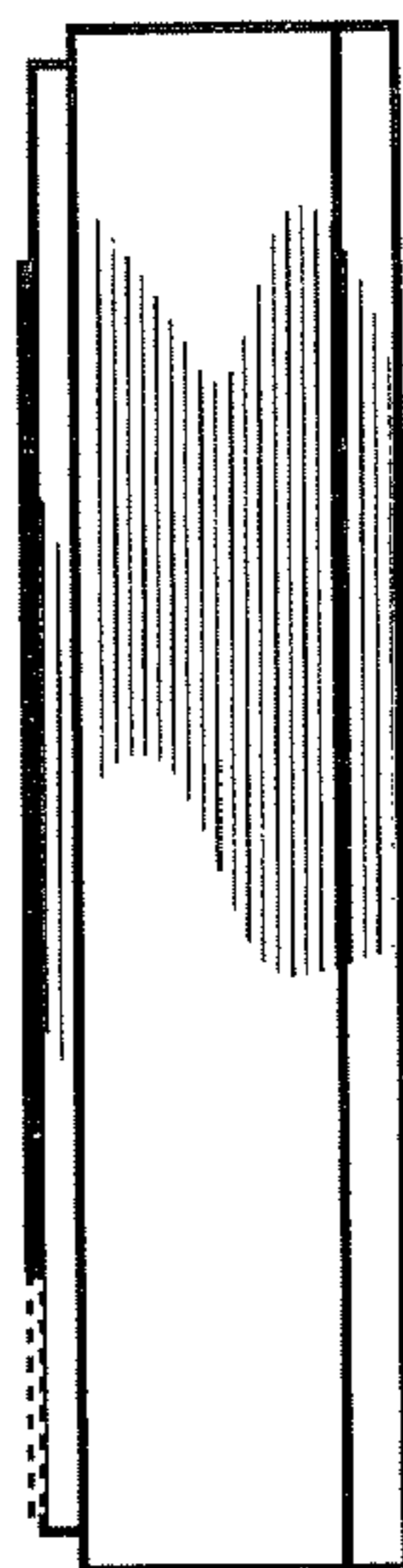

FIG. 10

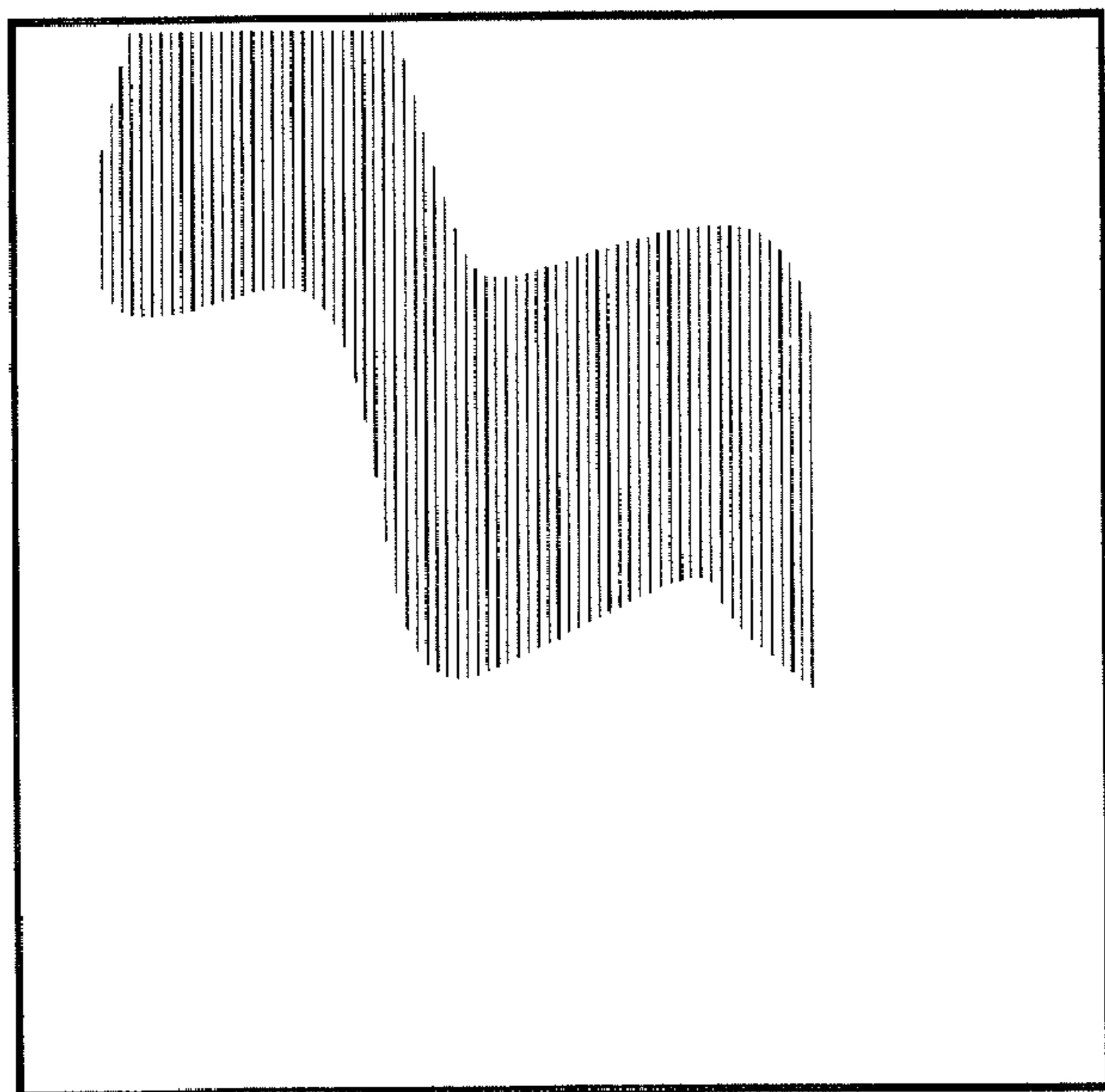

FIG. 11

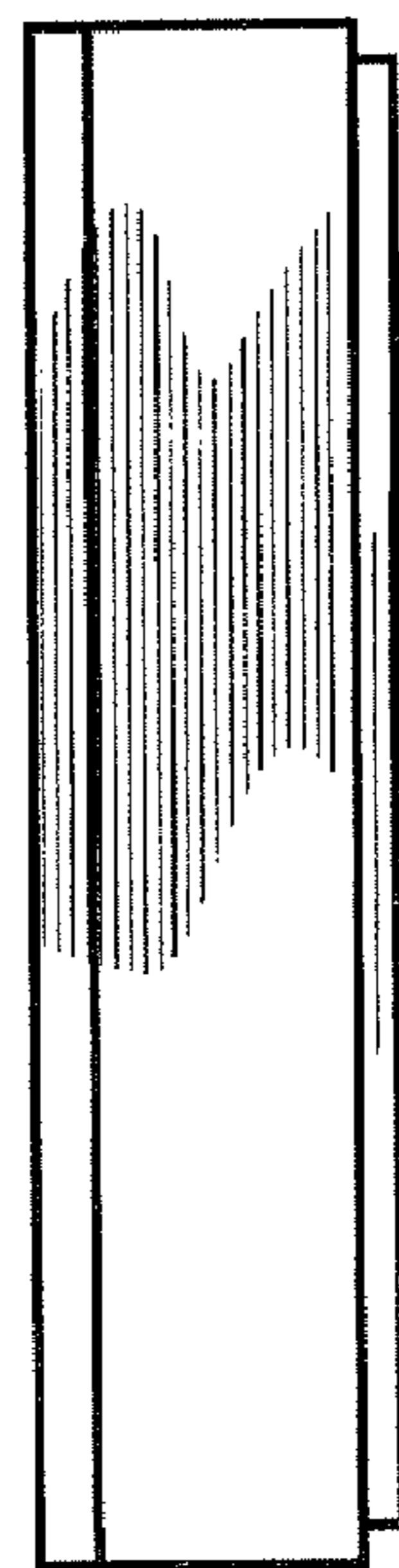

FIG. 12

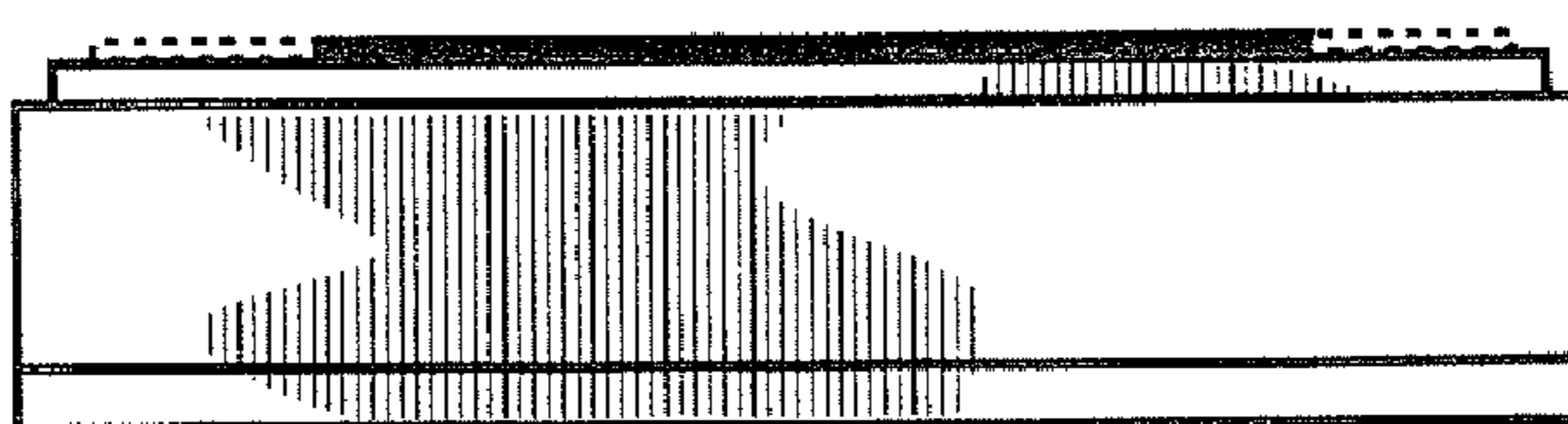

FIG. 13

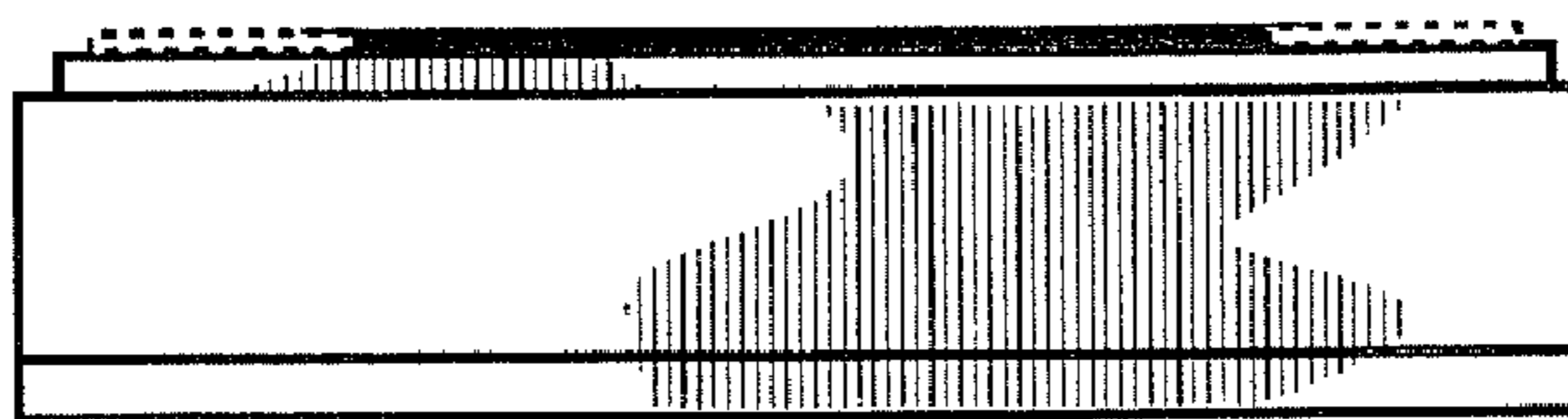

FIG. 14