



US00D602396S

(12) **United States Design Patent**
Conway et al.

(10) **Patent No.:** **US D602,396 S**
(45) **Date of Patent:** **** Oct. 20, 2009**

(54) **TALL VASE**

(75) Inventors: **Simon M. Conway**, Burlington, WI (US); **Kit R. Morris**, Austin, TX (US); **Steven Meosky**, Austin, TX (US); **Han Xin**, Austin, TX (US)

(73) Assignee: **S.C. Johnson & Son, Inc.**, Racine, WI (US)

(**) Term: **14 Years**

(21) Appl. No.: **29/321,028**

(22) Filed: **Jul. 9, 2008**

(51) **LOC (9) Cl.** **11-02**

(52) **U.S. Cl.** **D11/146**

(58) **Field of Classification Search** D6/556–558; D8/1; D11/143–146; D19/77, 80, 81; D26/9, D26/16; D34/1, 2, 4–6; D99/5, 19; 47/33, 47/41.01, 41.1, 41.11–41.15, 65.5, 66.6, 47/66.7, 67, 71

See application file for complete search history.

(56) **References Cited**

U.S. PATENT DOCUMENTS

D119,619	S	*	3/1940	Fuerst	D11/154
D119,620	S	*	3/1940	Fuerst	D11/154
D119,621	S	*	3/1940	Fuerst	D11/154
D121,896	S	*	8/1940	Fuerst	D11/154
3,747,902	A		7/1973	Bailey		
3,804,331	A		4/1974	Levey		
4,020,978	A		5/1977	Szczepanski		
4,327,518	A		5/1982	Knauff		
4,377,399	A		3/1983	Bryson		
4,452,393	A		6/1984	Schimanski et al.		
D282,152	S	*	1/1986	Mendenhall	D11/154
4,666,638	A		5/1987	Baker et al.		
4,743,406	A		5/1988	Steiner et al.		
4,931,224	A		6/1990	Holzner, Sr.		
5,050,798	A		9/1991	Sullivan		
5,269,460	A		12/1993	Hautmann		

5,353,546	A	*	10/1994	Bock	47/66.6
D358,115	S	*	5/1995	Rahr	D11/144
5,526,830	A		6/1996	Hunter		
5,573,325	A		11/1996	Lekowski		
6,912,355	B2		6/2005	Vieira		
D513,479	S	*	1/2006	Behrens	D11/144
D542,707	S	*	5/2007	Kolokotronis et al.	D11/153
D574,294	S	*	8/2008	Heathcock et al.	D11/144
D581,035	S	*	11/2008	Conway et al.	D23/366
D582,534	S	*	12/2008	Conway et al.	D11/152
2005/0084569	A1		4/2005	Hu et al.		
2005/0249474	A1		11/2005	Tan		
2006/0081721	A1		4/2006	Caserta et al.		
2007/0185434	A1		8/2007	Denisart et al.		
2009/0049743	A1*		2/2009	Lewis, Jr.	47/41.01

FOREIGN PATENT DOCUMENTS

GB 3017606 * 7/2004

* cited by examiner

Primary Examiner—Caron Veynar

Assistant Examiner—Garth Rademaker

(57) **CLAIM**

The ornamental design for a tall vase, as shown and described.

DESCRIPTION

FIG. 1 is a perspective view of a tall vase, showing our new design;

FIG. 2 is a front elevational view of the tall vase of FIG. 1;

FIG. 3 is a rear view of the tall vase of FIG. 1;

FIG. 4 is a right side view of the tall vase of FIG. 1;

FIG. 5 is left side view of the tall vase of FIG. 1;

FIG. 6 is a top view of the tall vase of FIG. 1; and,

FIG. 7 is a bottom view of the tall vase of FIG. 1.

The lines shown in phantom are for illustrative and environmental purposes only, are disclaimed, and form no part of the claimed design.

1 Claim, 3 Drawing Sheets

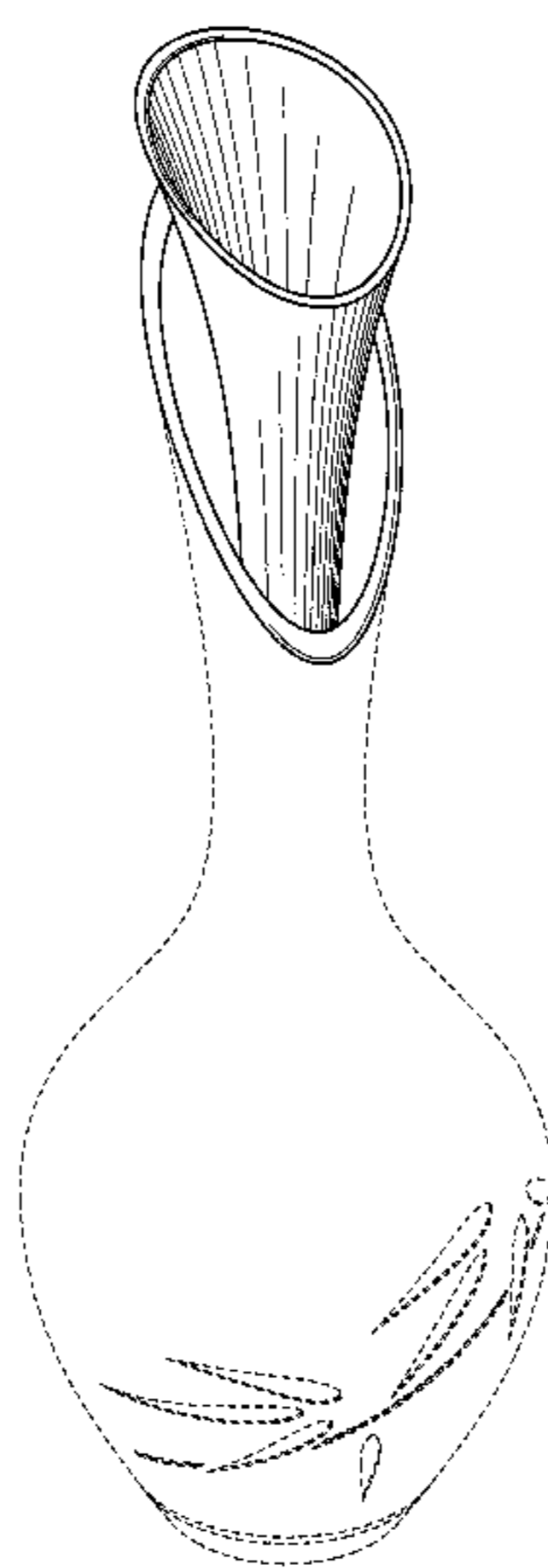

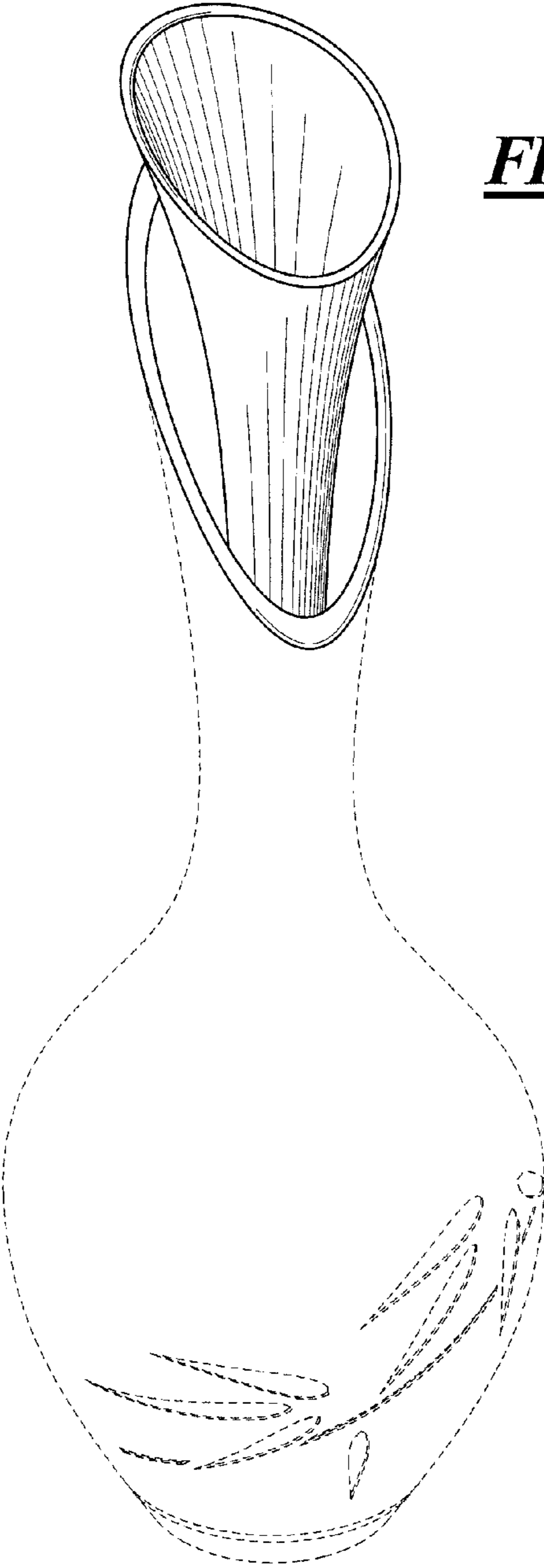

FIG. 1

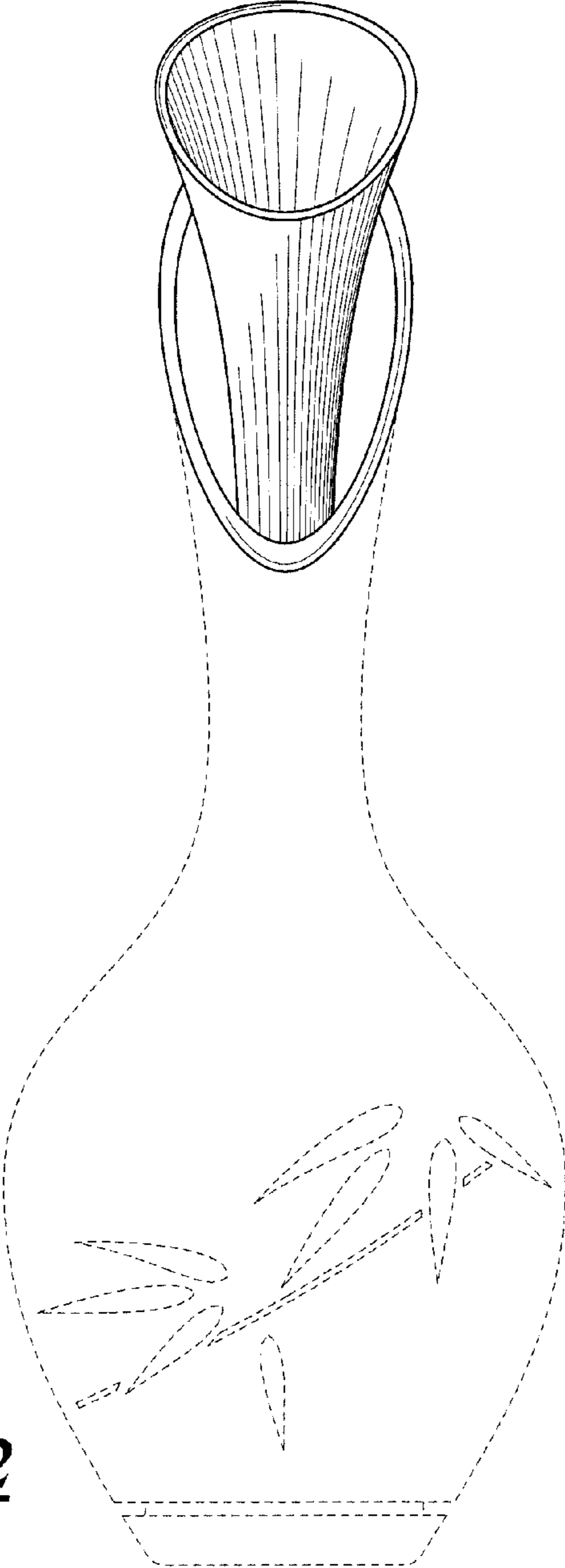

FIG. 2

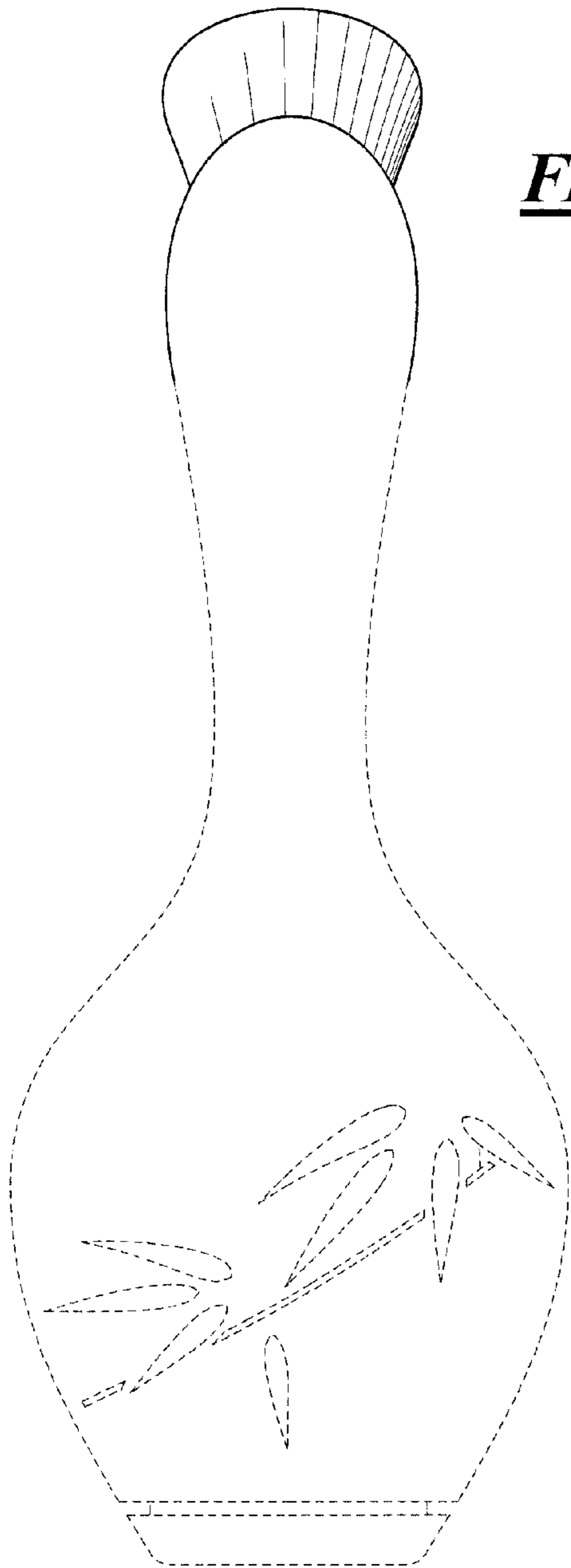

FIG. 3

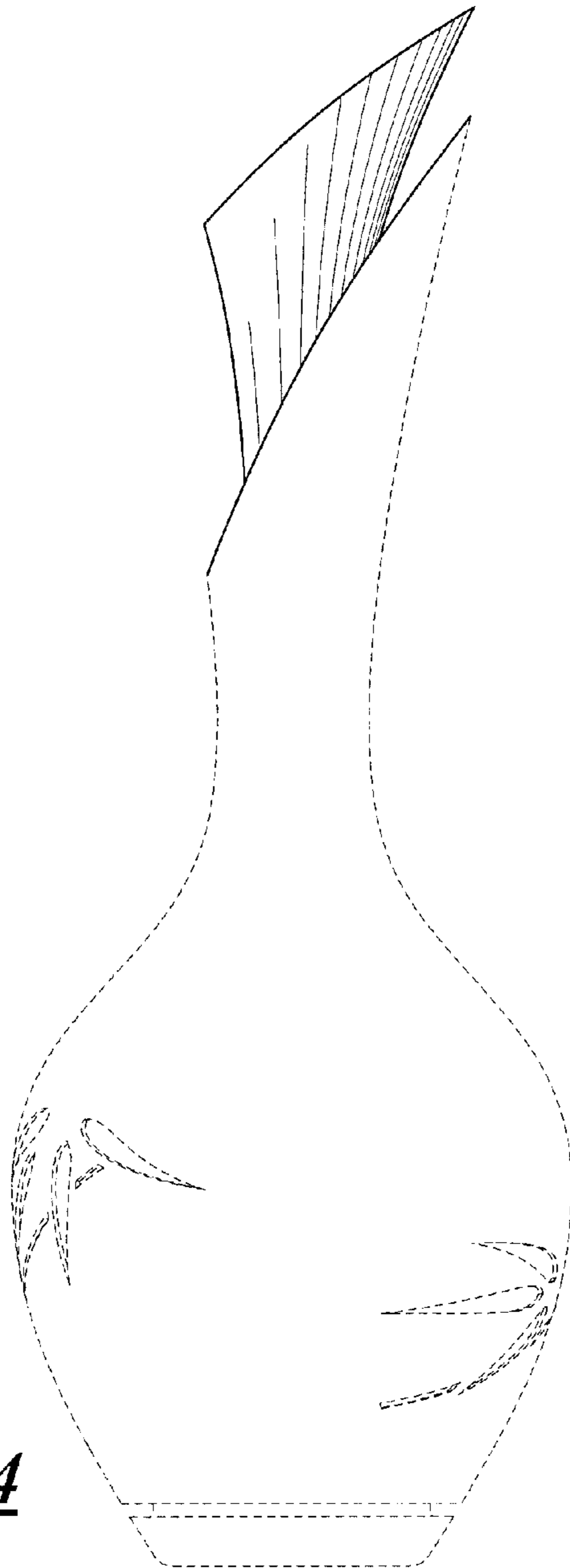

FIG. 4

FIG. 5

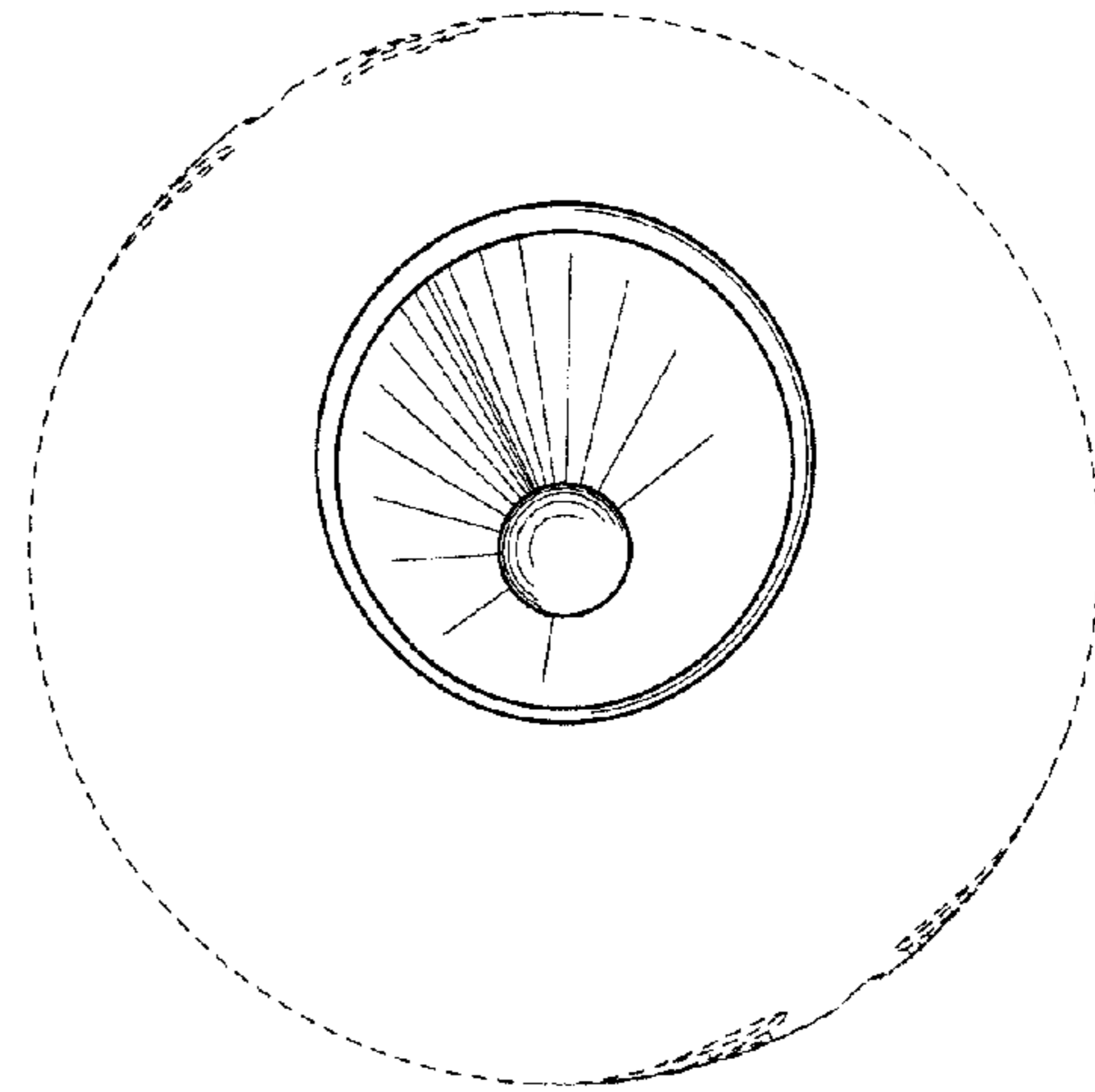
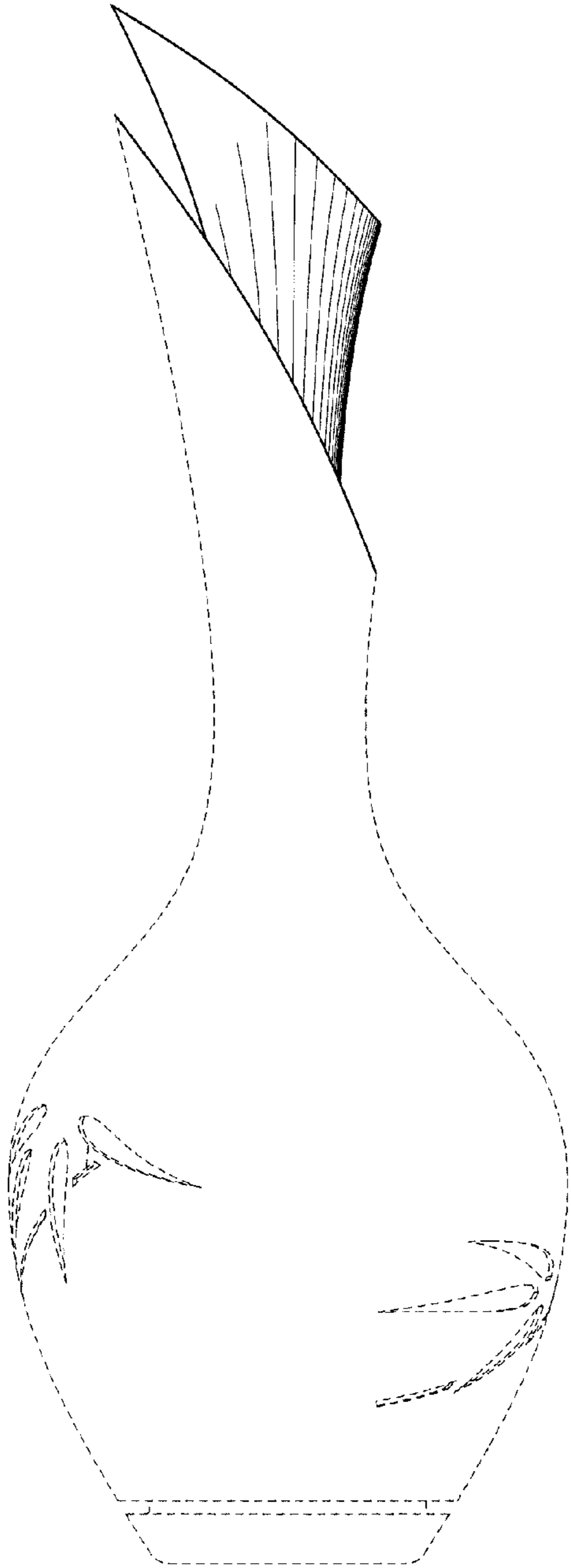

FIG. 6

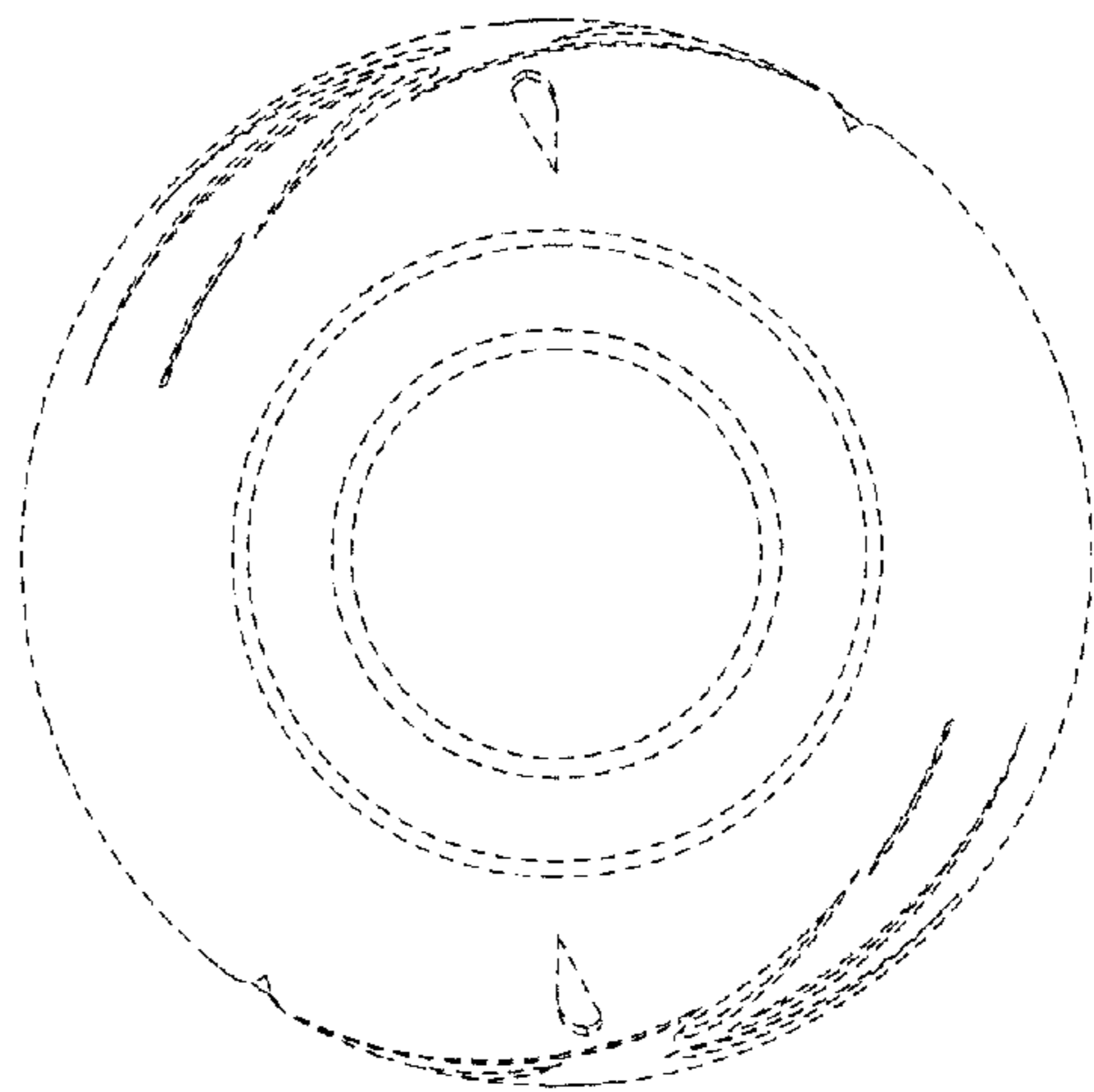

FIG. 7

UNITED STATES PATENT AND TRADEMARK OFFICE
CERTIFICATE OF CORRECTION

PATENT NO. : Des. 602,396 S
APPLICATION NO. : 29/321028
DATED : October 20, 2009
INVENTOR(S) : Simon M. Conway et al.

Page 1 of 1

It is certified that error appears in the above-identified patent and that said Letters Patent is hereby corrected as shown below:

Cover page item (75), Inventors: replace "Steven Meosky" with --Stephen Meosky--

Signed and Sealed this

Sixteenth Day of November, 2010

A handwritten signature in black ink that reads "David J. Kappos". The signature is written in a cursive, flowing style.

David J. Kappos
Director of the United States Patent and Trademark Office