



US00D602278S

(12) **United States Design Patent**  
**Kubryk**

(10) **Patent No.:** **US D602,278 S**

(45) **Date of Patent:** **\*\* Oct. 20, 2009**

(54) **STACKABLE CHAIR**

(76) **Inventor:** **Isaac Kubryk**, 1111 Eagle Nest Ct.,  
Danville, CA (US) 94506

(\*\*) **Term:** **14 Years**

(21) **Appl. No.:** **29/314,573**

(22) **Filed:** **Apr. 10, 2009**

(51) **LOC (9) Cl.** ..... **06-01**

(52) **U.S. Cl.** ..... **D6/380**

(58) **Field of Classification Search** ..... D6/334-336,  
D6/374, 375, 376, 379, 380, 500-502; 297/239,  
297/445.1, 446.1, 452.48

See application file for complete search history.

(56) **References Cited**

**U.S. PATENT DOCUMENTS**

D153,101 S *	3/1949	Bellin	.....	D6/380
D180,996 S *	9/1957	Cramer	.....	D6/380
D182,426 S *	4/1958	McCarthy et al.	.....	D6/380
D437,139 S *	2/2001	Beck	.....	D6/379
D520,256 S *	5/2006	King	.....	D6/374

D524,072 S *	7/2006	King	.....	D6/380
D555,929 S *	11/2007	Lewis	.....	D6/380
D570,617 S *	6/2008	Lewis	.....	D6/379

\* cited by examiner

*Primary Examiner*—Mimosa De

(74) *Attorney, Agent, or Firm*—Audrey A. Millemann;  
Weintraub Genshlea et al.

(57) **CLAIM**

The ornamental design for a stackable chair, as shown and described.

**DESCRIPTION**

FIG. 1 is a perspective view of a stackable chair, looking toward the right front corner, showing my new design;

FIG. 2 is a right side elevation view thereof;

FIG. 3 is a front view thereof;

FIG. 4 is a back view thereof;

FIG. 5 is a top view thereof; and,

FIG. 6 is a bottom view thereof.

**1 Claim, 5 Drawing Sheets**

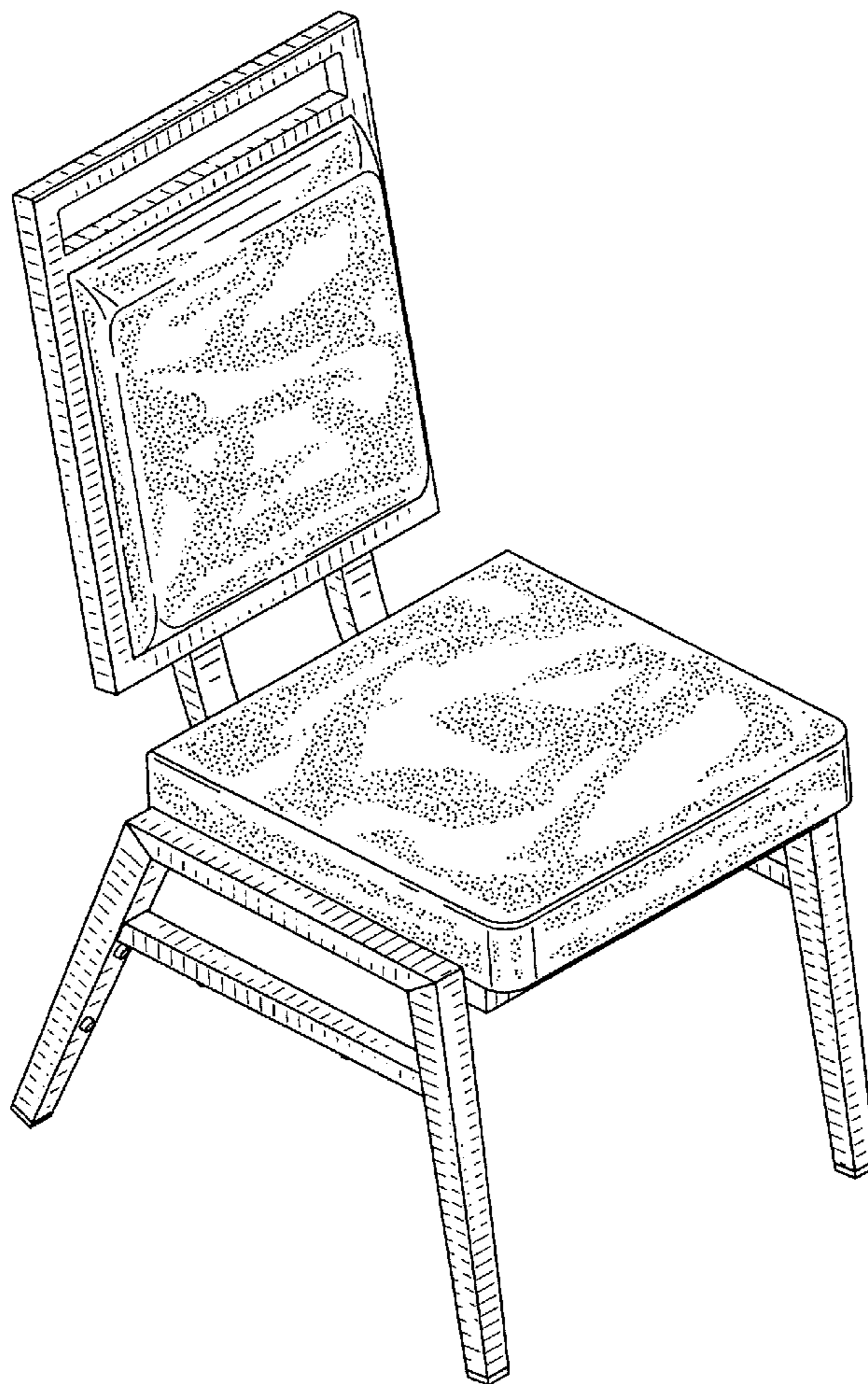

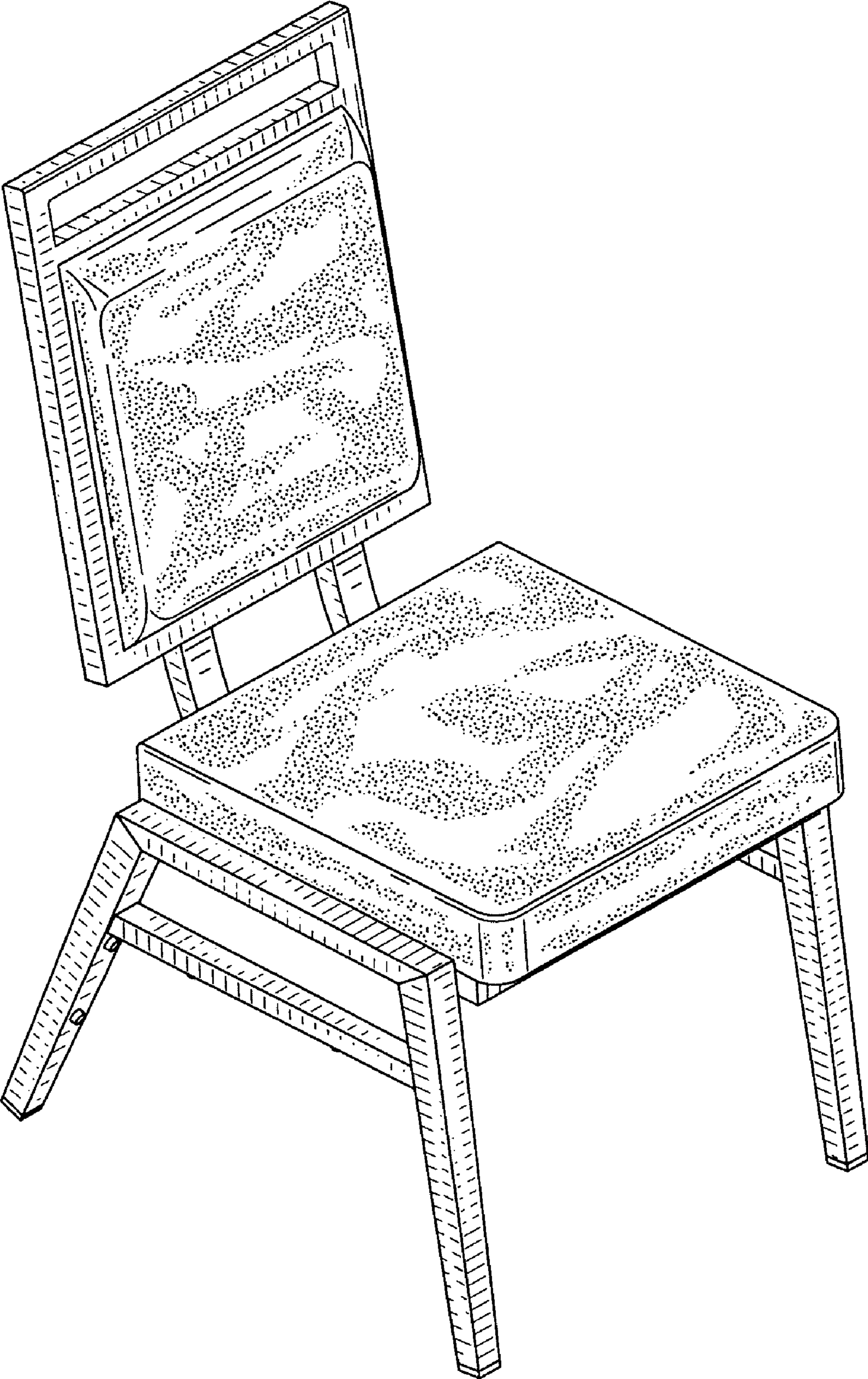

FIG. 1

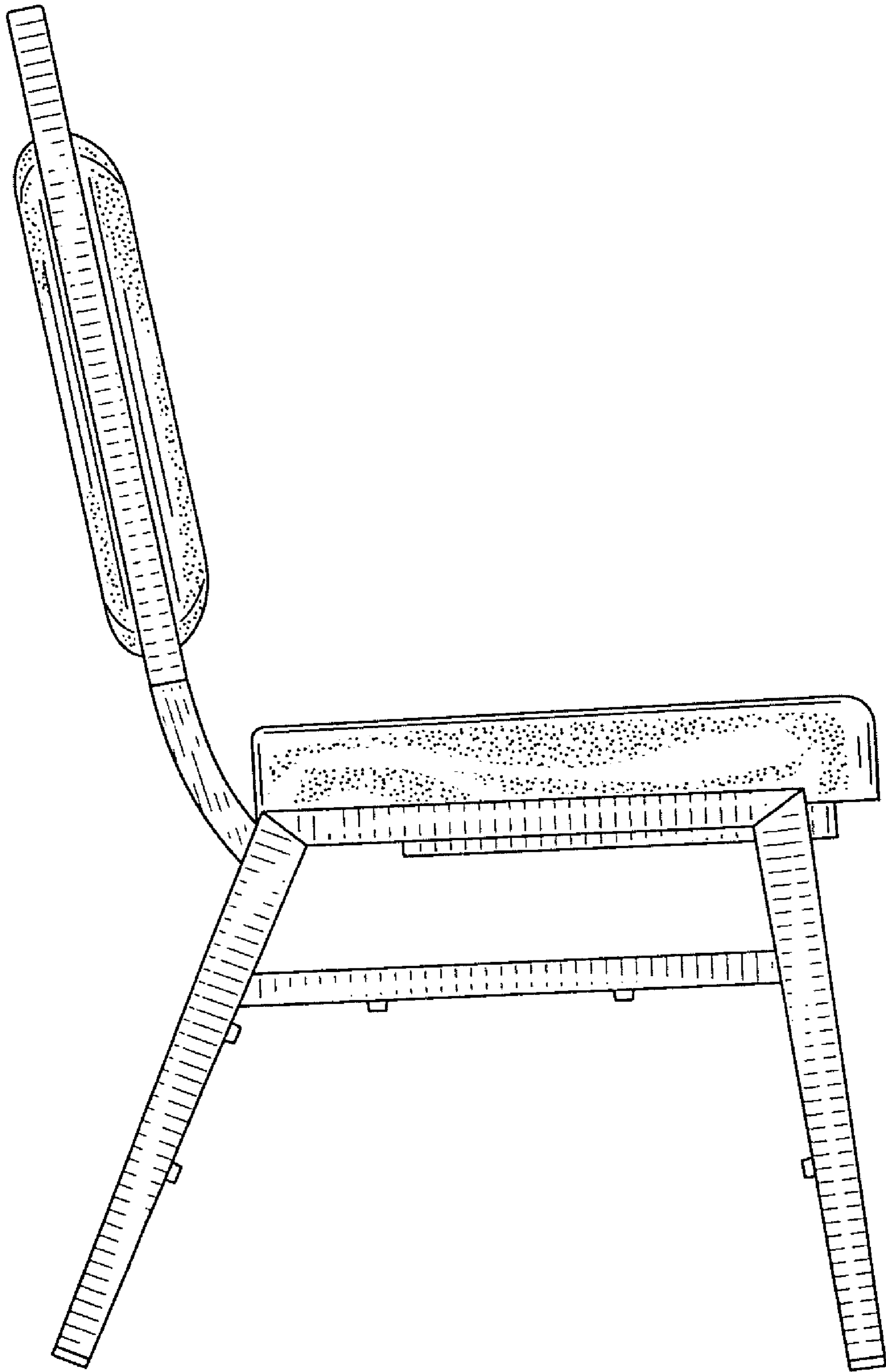

FIG. 2

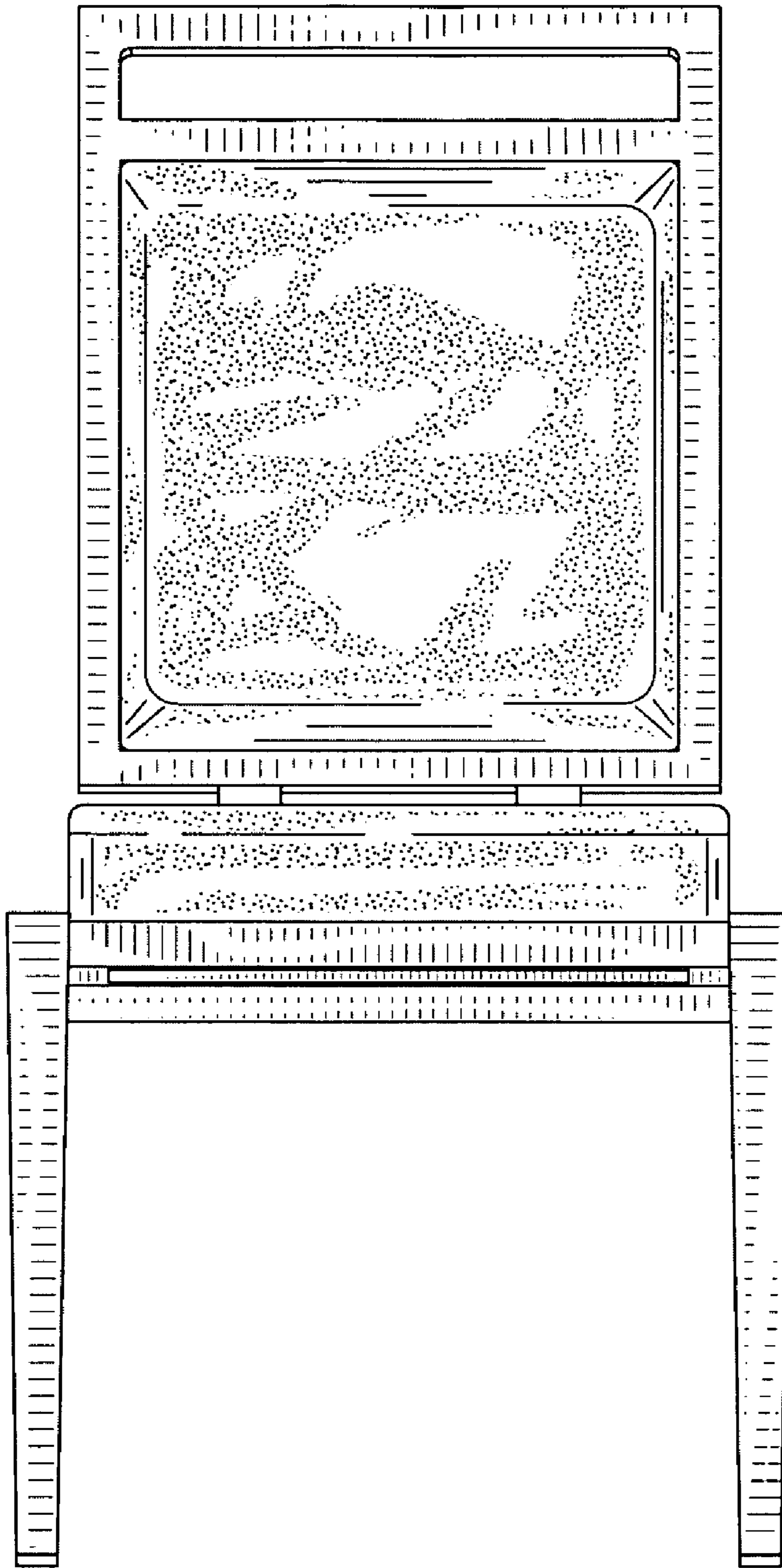

FIG. 3

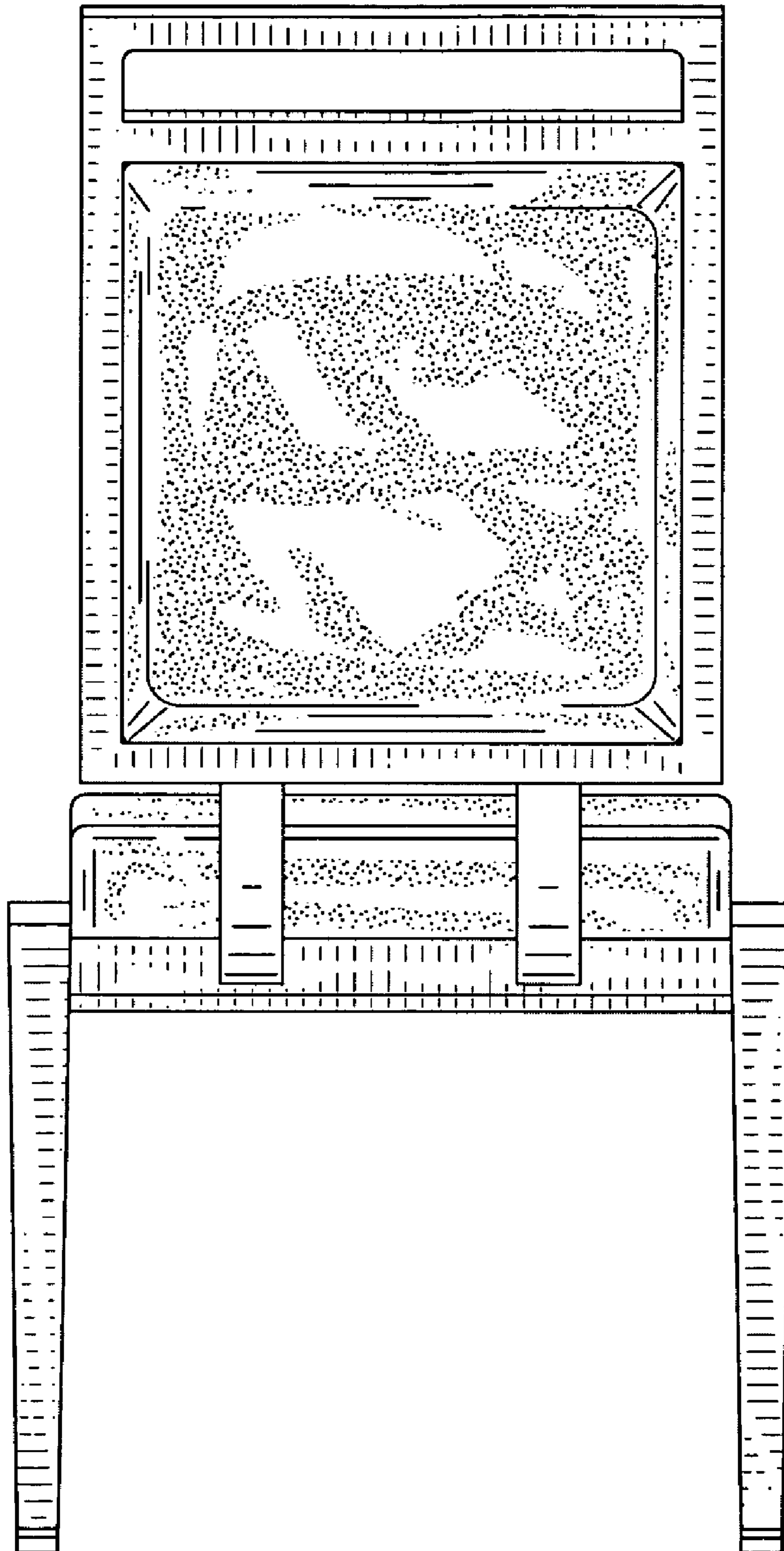

FIG. 4

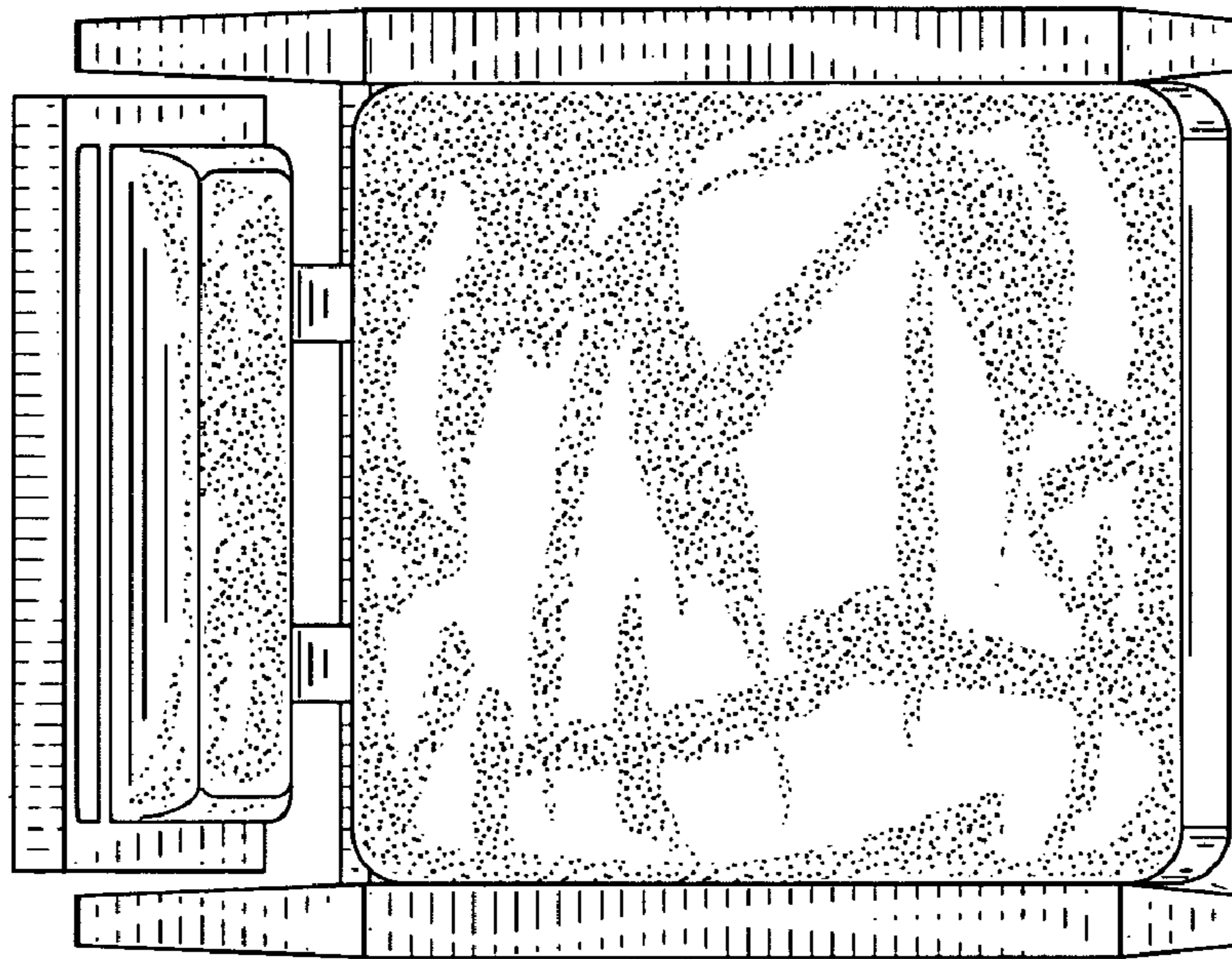

FIG. 5

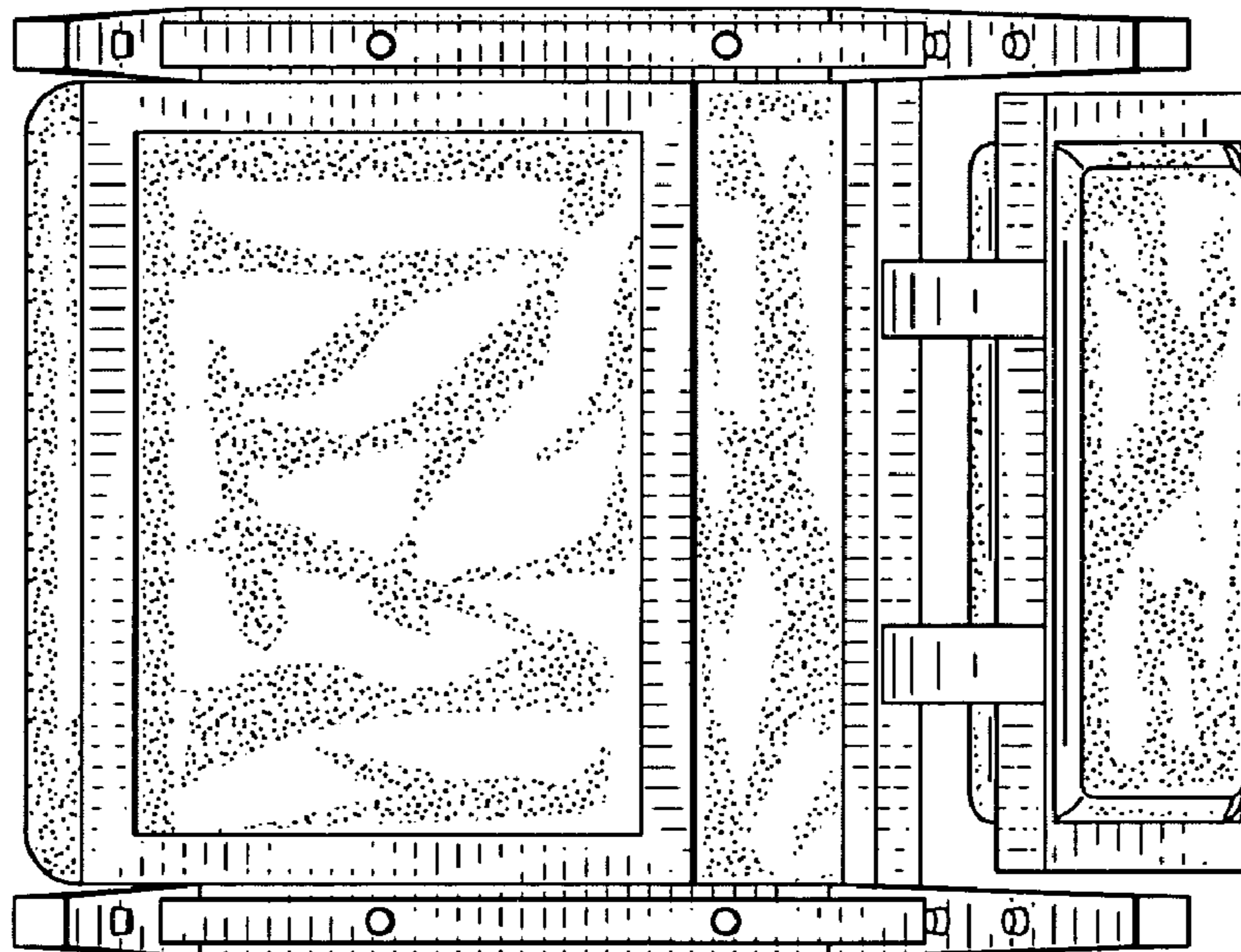

FIG. 6