



US00D602103S

(12) **United States Design Patent**
Jorgensen et al.

(10) **Patent No.:** **US D602,103 S**
(45) **Date of Patent:** **** Oct. 13, 2009**

(54) **IRON GOLF CLUB HEAD**

(75) Inventors: **Douglas C. Jorgensen**, Carlsbad, CA (US); **Kongdach Sethapun**, Pasadena, CA (US); **Daniel Remington Vehse**, Carlsbad, CA (US); **John Wooster**, Winnetka, IL (US)

(73) Assignee: **Acushnet Company**, Fairhaven, MA (US)

(**) Term: **14 Years**

(21) Appl. No.: **29/329,783**

(22) Filed: **Dec. 22, 2008**

(51) **LOC (9) Cl.** **21-02**

(52) **U.S. Cl.** **D21/747**

(58) **Field of Classification Search** D21/747-751;
473/324-331, 350

See application file for complete search history.

(56) **References Cited**

U.S. PATENT DOCUMENTS

D300,547 S	4/1989	Kobayashi
D501,035 S	1/2005	Wahl et al.
D517,626 S	3/2006	Gilbert et al.
D540,898 S	4/2007	Solheim et al.

D544,056 S	6/2007	Nicolette et al.
D556,848 S	12/2007	Ruggiero et al.
D579,996 S *	11/2008	Gilbert et al. D21/747
D581,000 S *	11/2008	Nicolette et al. D21/749

* cited by examiner

Primary Examiner—Mitchell I Siegel

(74) *Attorney, Agent, or Firm*—Kristin D. Wheeler

(57) **CLAIM**

The ornamental design for an iron golf club head, as shown and described.

DESCRIPTION

FIG. 1 is a back, heel perspective view of our new iron golf club head;

FIG. 2 is a back view thereof;

FIG. 3 is a top view thereof;

FIG. 4 is a front view thereof;

FIG. 5 is a bottom view thereof;

FIG. 6 is a heel side view thereof; and,

FIG. 7 is a toe side view thereof.

The portion of the iron shown in phantom does not form any portion of the present invention.

1 Claim, 3 Drawing Sheets

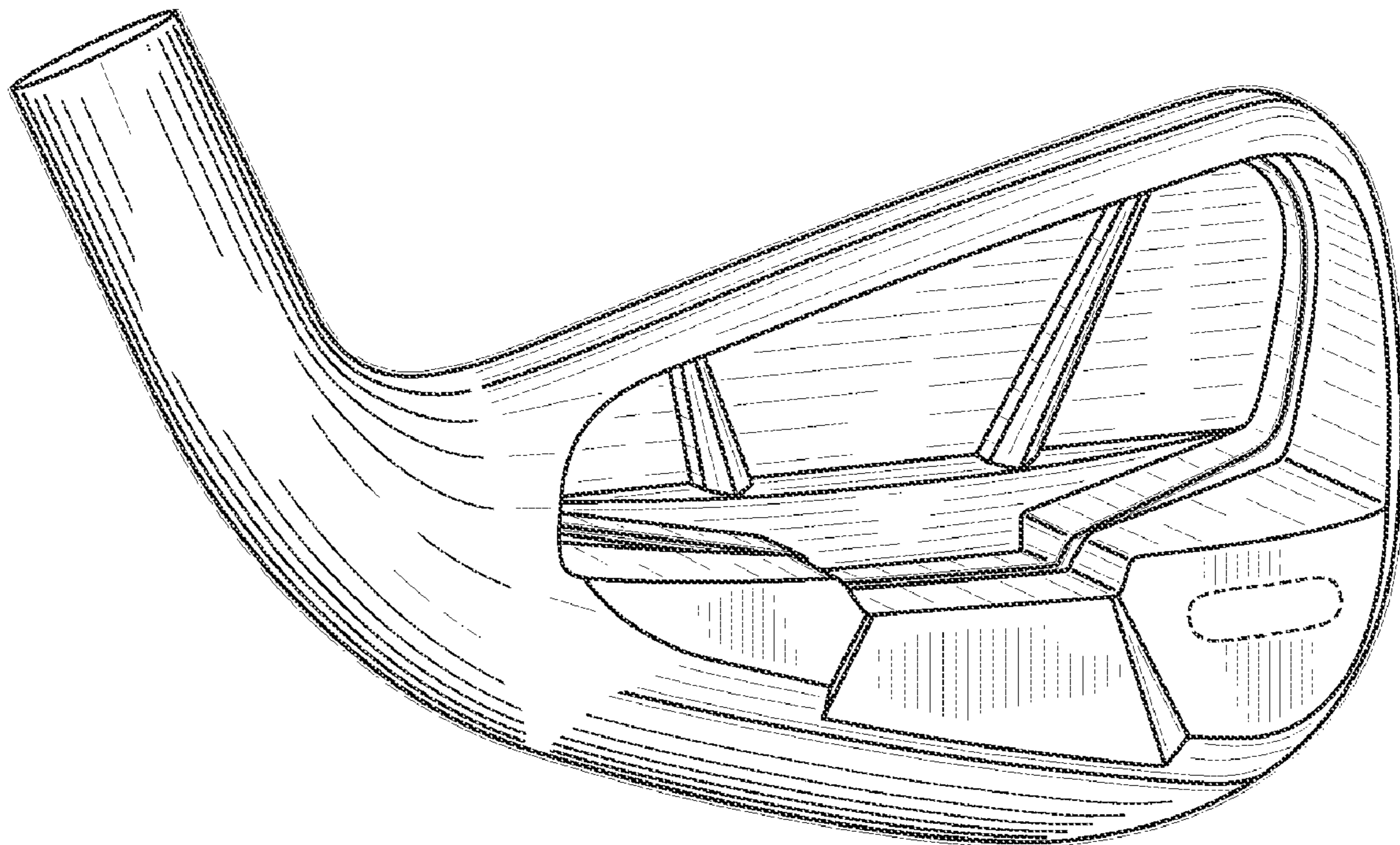

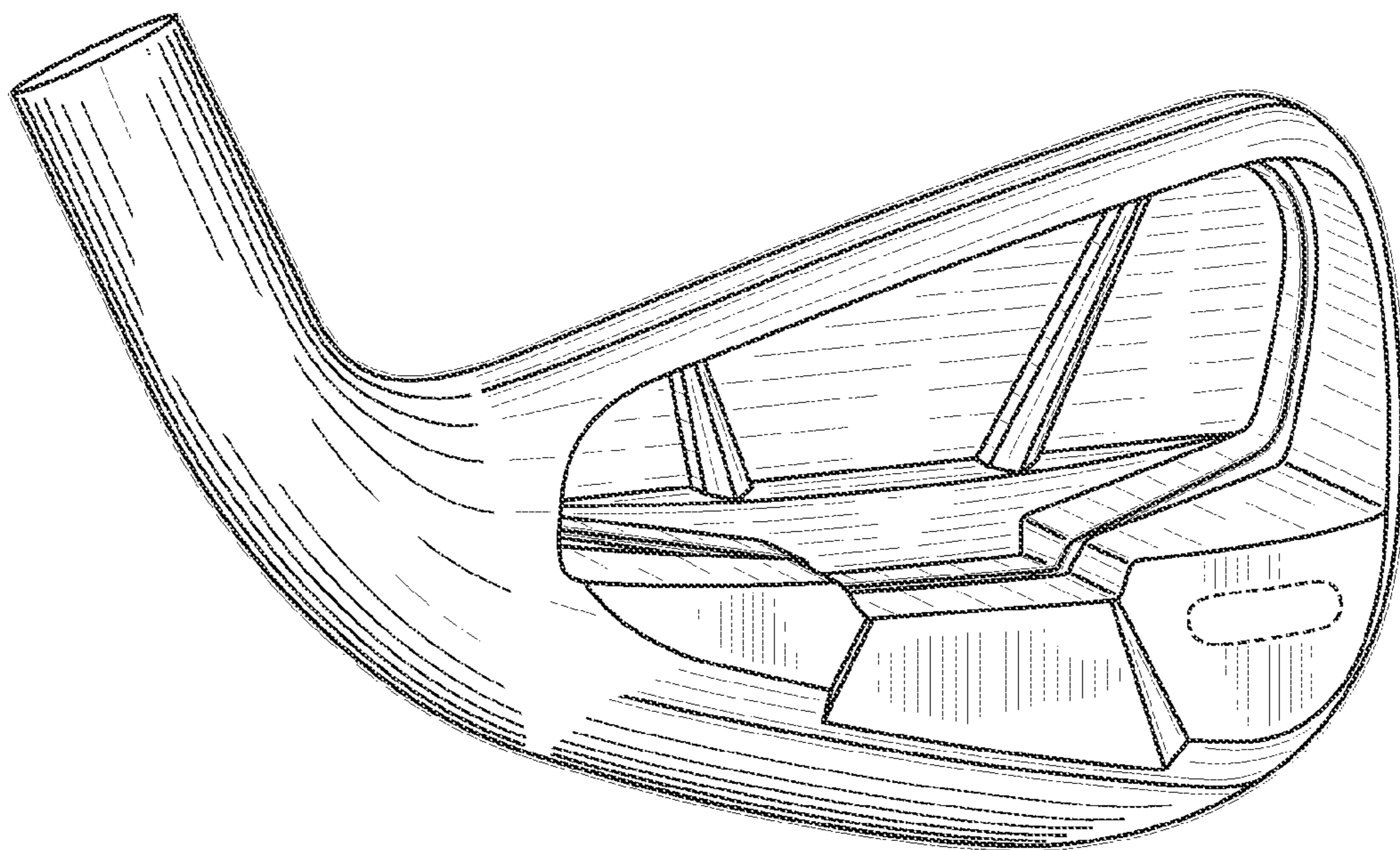

FIG. 1

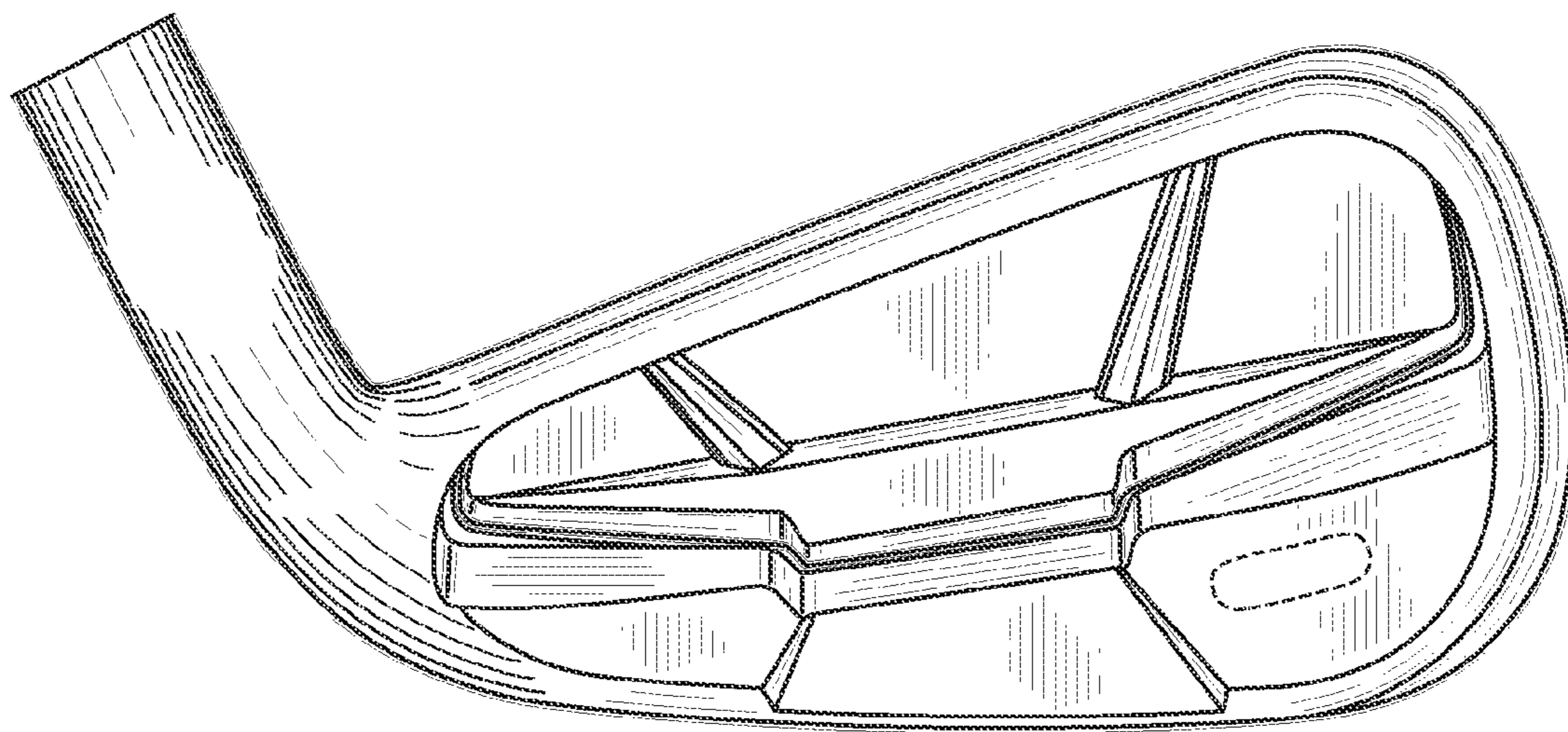

FIG. 2

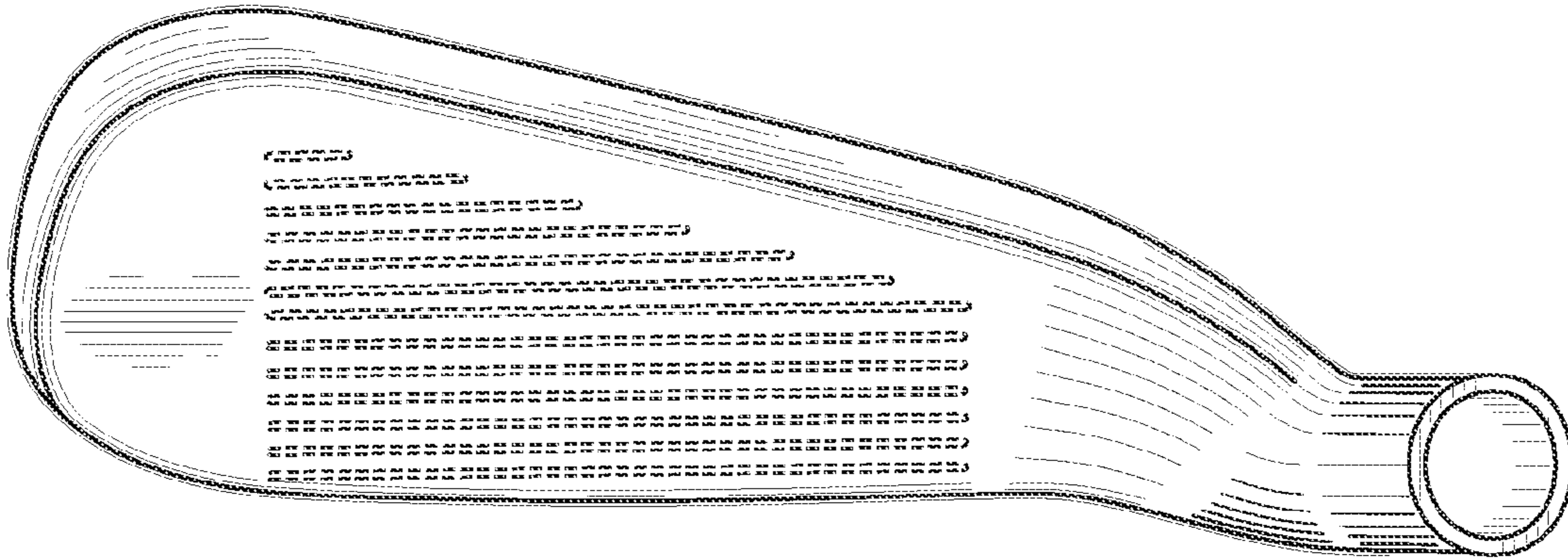

FIG. 3

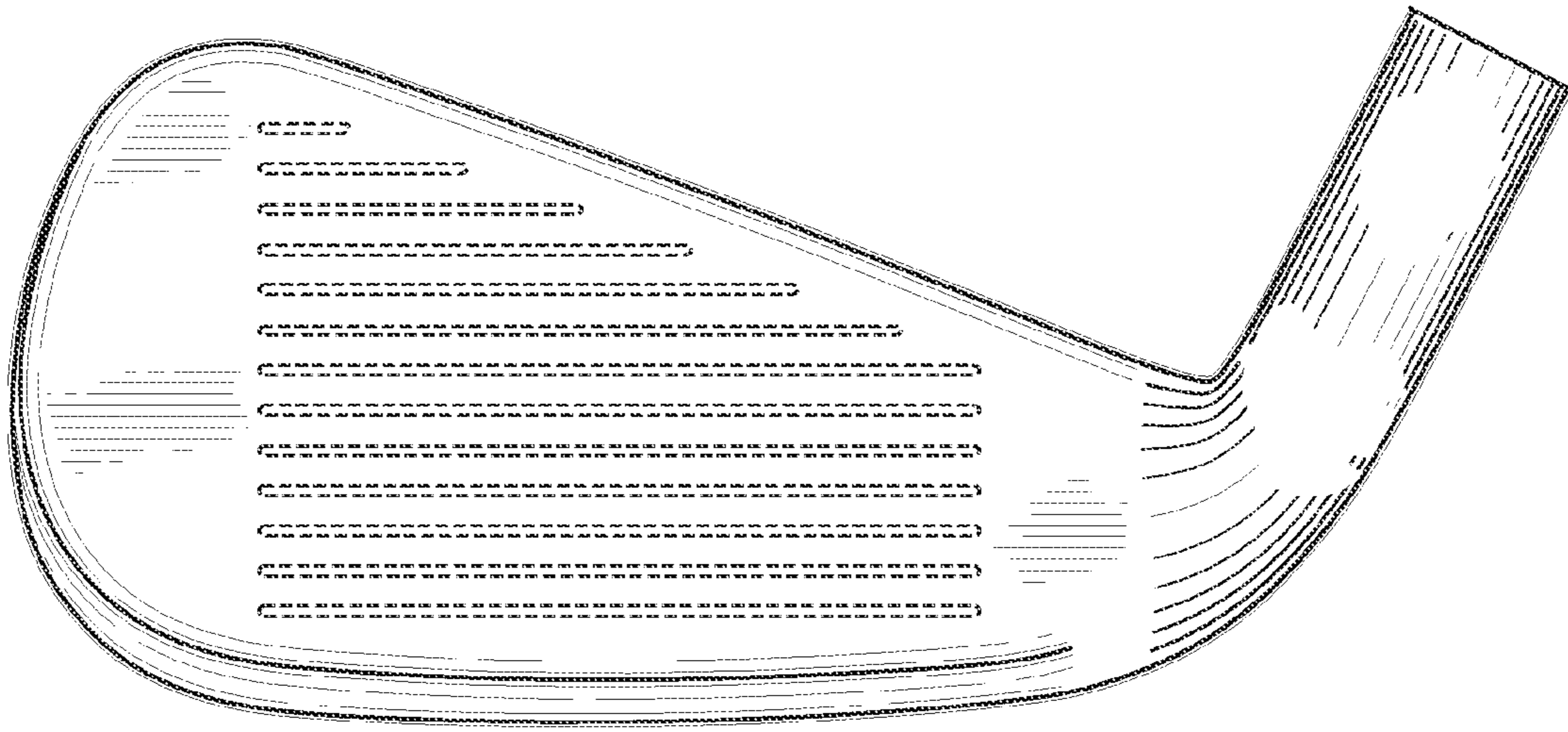

FIG. 4

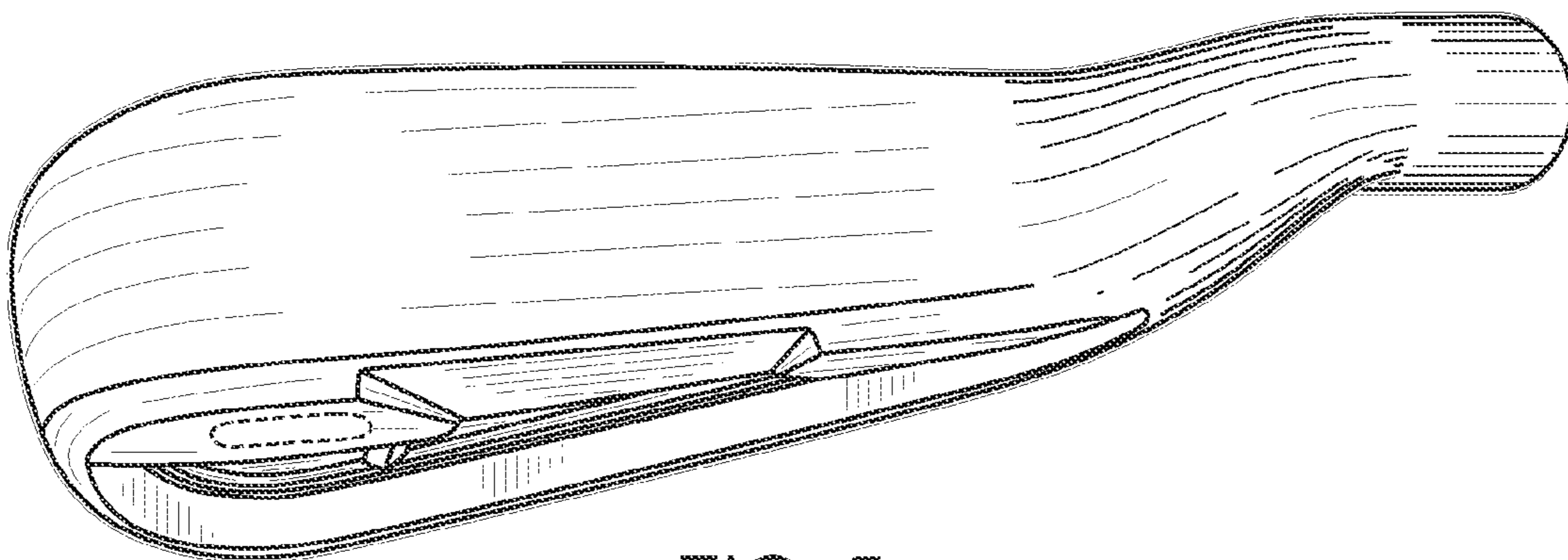

FIG. 5

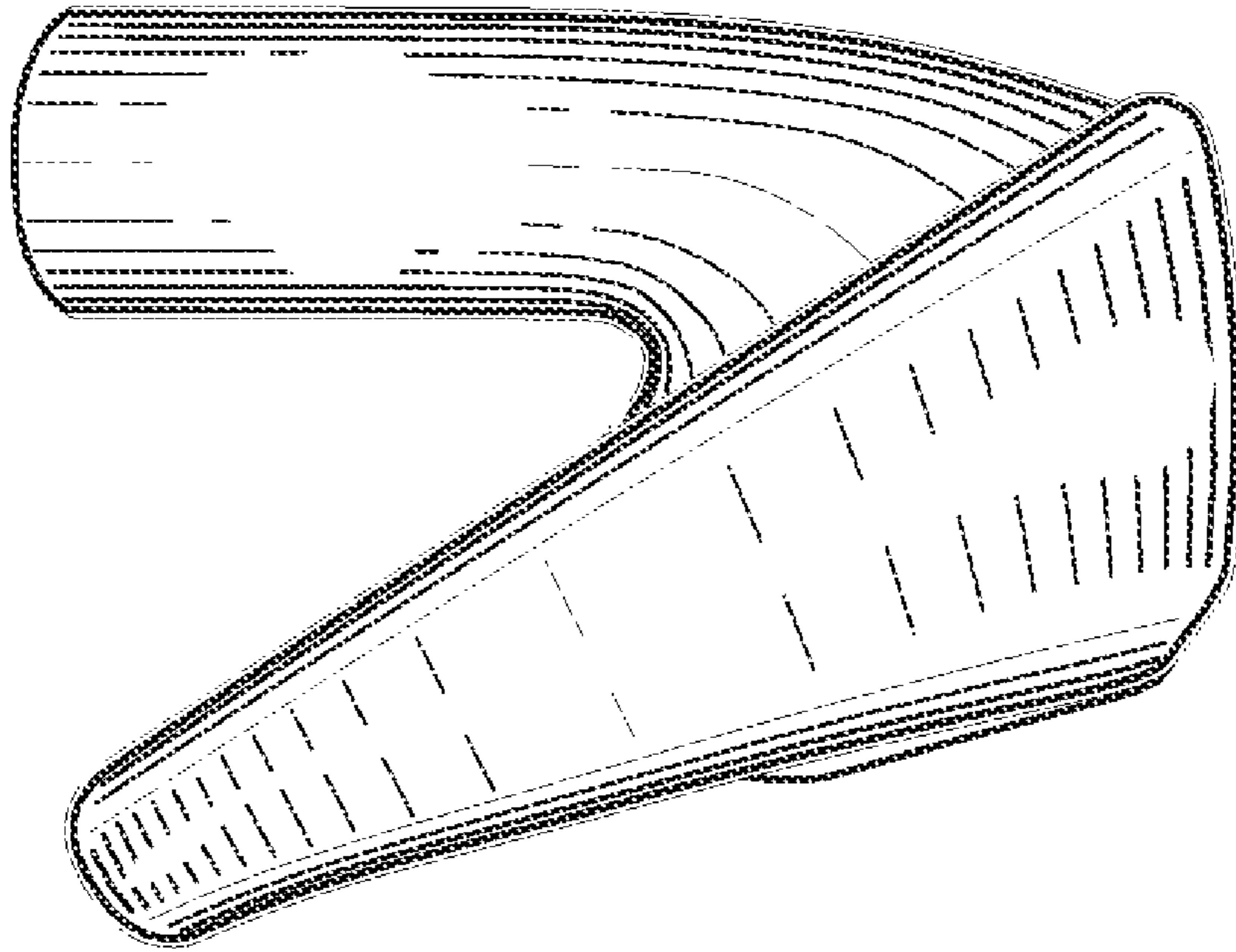

FIG. 6

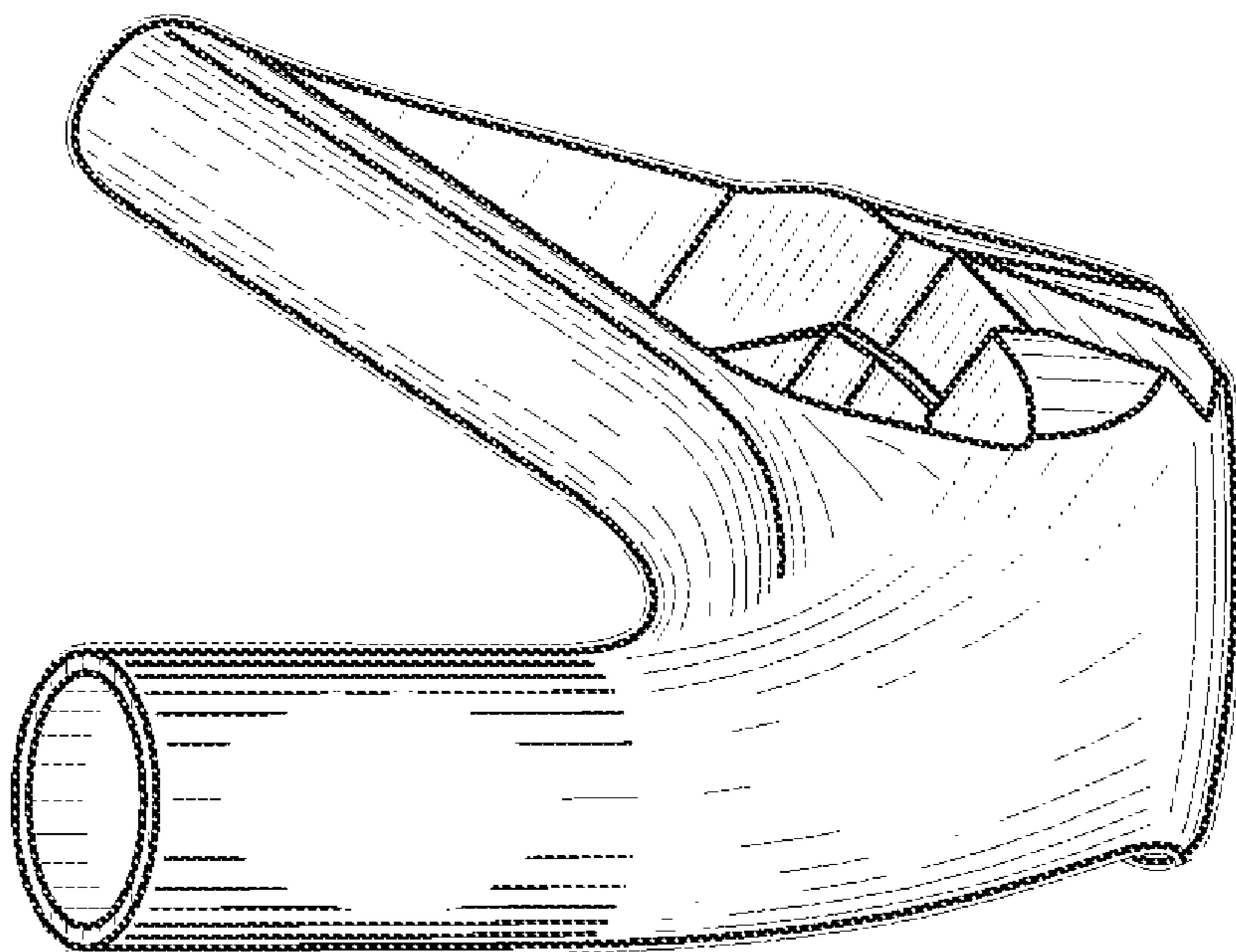

FIG. 7