



US00D602020S

(12) **United States Design Patent**
Haspil et al.

(10) **Patent No.:** **US D602,020 S**
(45) **Date of Patent:** **** Oct. 13, 2009**

(54) **WIRELESS ACCESS POINT**

(75) Inventors: **John Haspil**, Boerne, TX (US); **Susan S. Steele**, Alpharetta, GA (US); **David Mornhineway**, San Antonio, TX (US); **Jerry O’Leary**, Chicago, IL (US); **Larry B. Pearson**, San Antonio, TX (US); **Tyler Wallis**, San Antonio, TX (US)

(73) Assignee: **AT&T Intellectual Property I, L.P.**, Reno, NV (US)

(**) Term: **14 Years**

(21) Appl. No.: **29/284,421**

(22) Filed: **Sep. 7, 2007**

(51) **LOC (9) Cl.** **14-02**
(52) **U.S. Cl.** **D14/358**
(58) **Field of Classification Search** D14/356,
D14/358, 432, 433, 137, 138, 140, 155, 188,
D14/217, 240, 299, 191; D13/110, 184;
439/488, 490, 901; 379/1.03, 38, 39, 42,
379/67.1, 88.17, 90.01, 93.01, 93.17, 142.07,
379/219, 220.01, 221.14, 221.15, 387.01,
379/397, 399.01, 419, 428.01, 457; 455/3.01,
455/3.05, 3.06, 426.1, 500, 73, 74, 556.1,
455/561, 575.1, 89, 91, 95, 130, 132, 344,
455/347, 899, FOR. 254

See application file for complete search history.

(56) **References Cited**

U.S. PATENT DOCUMENTS

D490,424 S * 5/2004 Yamanashi D14/358

D520,500 S * 5/2006 Storti et al. D14/358
D520,503 S * 5/2006 Shimizu D14/358
D561,750 S * 2/2008 Liu et al. D14/358
D562,814 S * 2/2008 Liu et al. D14/358
D566,115 S * 4/2008 Swanson et al. D14/358
D580,422 S * 11/2008 Lee D14/358
D583,367 S * 12/2008 Chen D14/358

* cited by examiner

Primary Examiner—Brian N Vinson

(74) *Attorney, Agent, or Firm*—Akerman Senterfitt LLP; Eduardo Guntin

(57) **CLAIM**

What is claimed is the ornamental design for a wireless access point, as shown and described.

DESCRIPTION

FIG. 1 is a perspective front view of a wireless access point showing our new design;

FIG. 2 is a left side view of a ornamental design of FIG. 1;

FIG. 3 is a right side view of the ornamental design of FIG. 1;

FIG. 4 is a front view of the ornamental design of FIG. 1;

FIG. 5 is a rear view of the ornamental design of FIG. 1;

FIG. 6 is a top plan view of the ornamental design of FIG. 1; and,

FIG. 7 is a bottom plan view of the ornamental design of FIG. 1.

The broken line disclosure in the views is understood to represent portions of the article in which the claimed design is embodied, but which form no part of the claimed design.

1 Claim, 7 Drawing Sheets

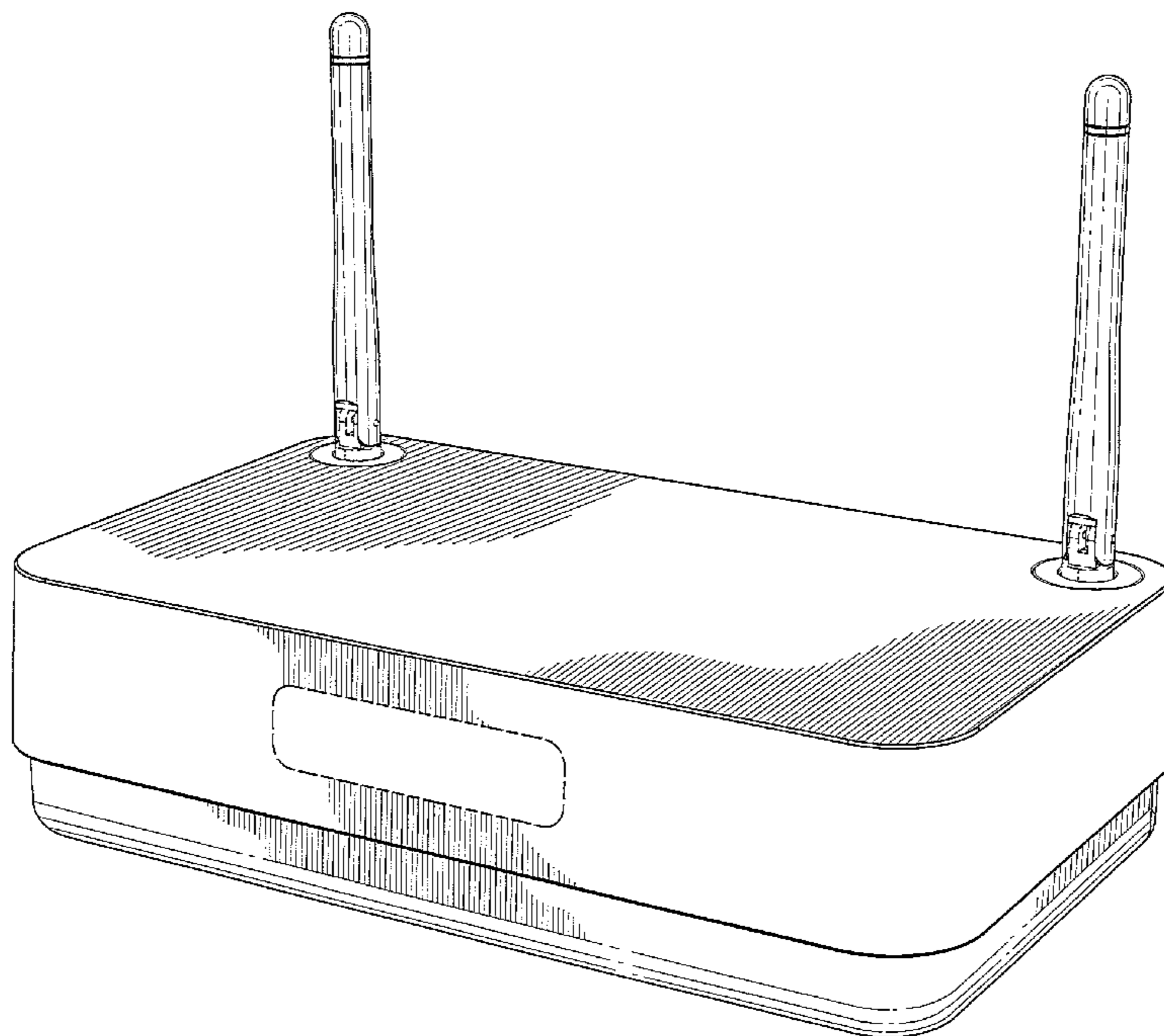

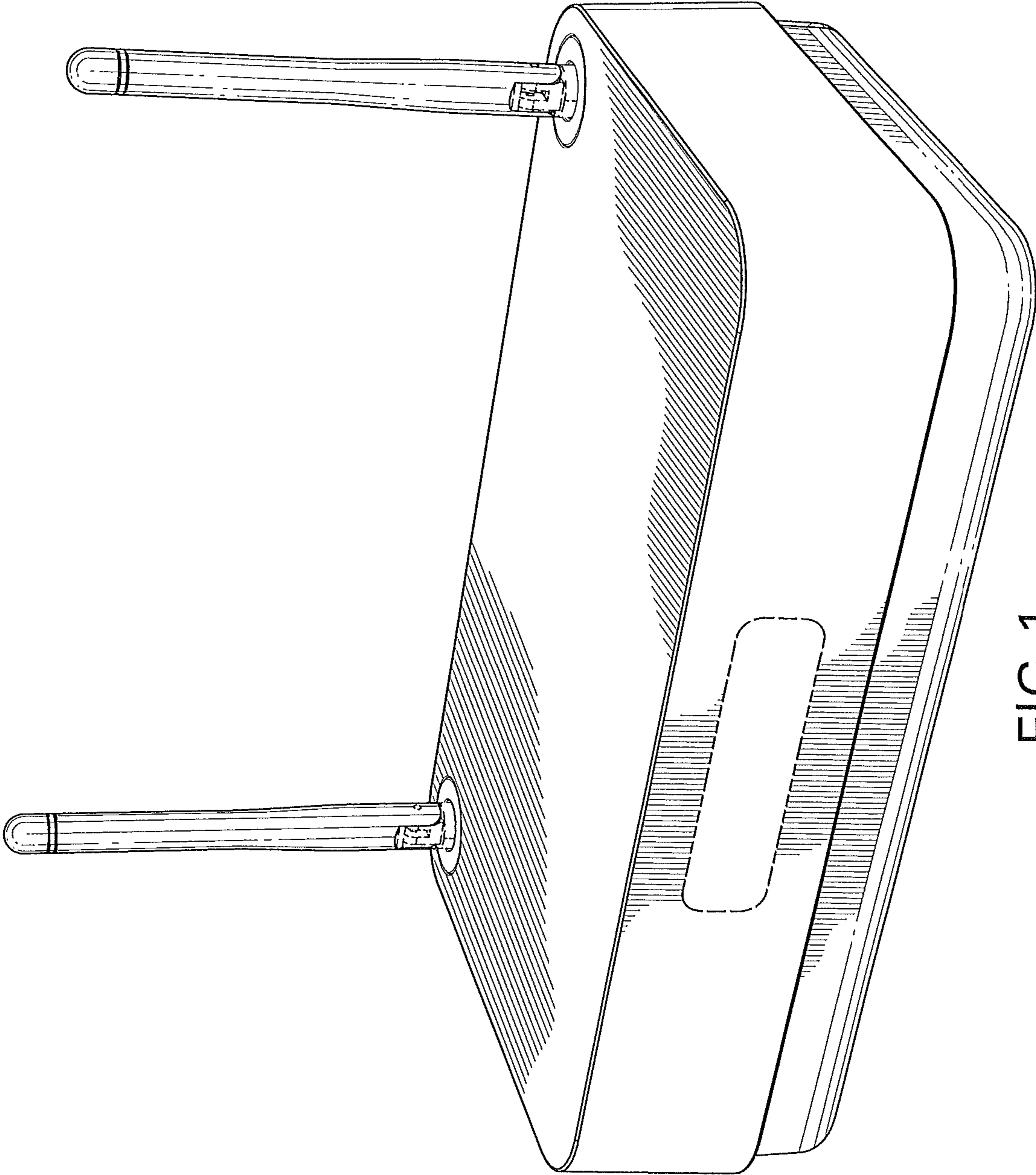

FIG. 1

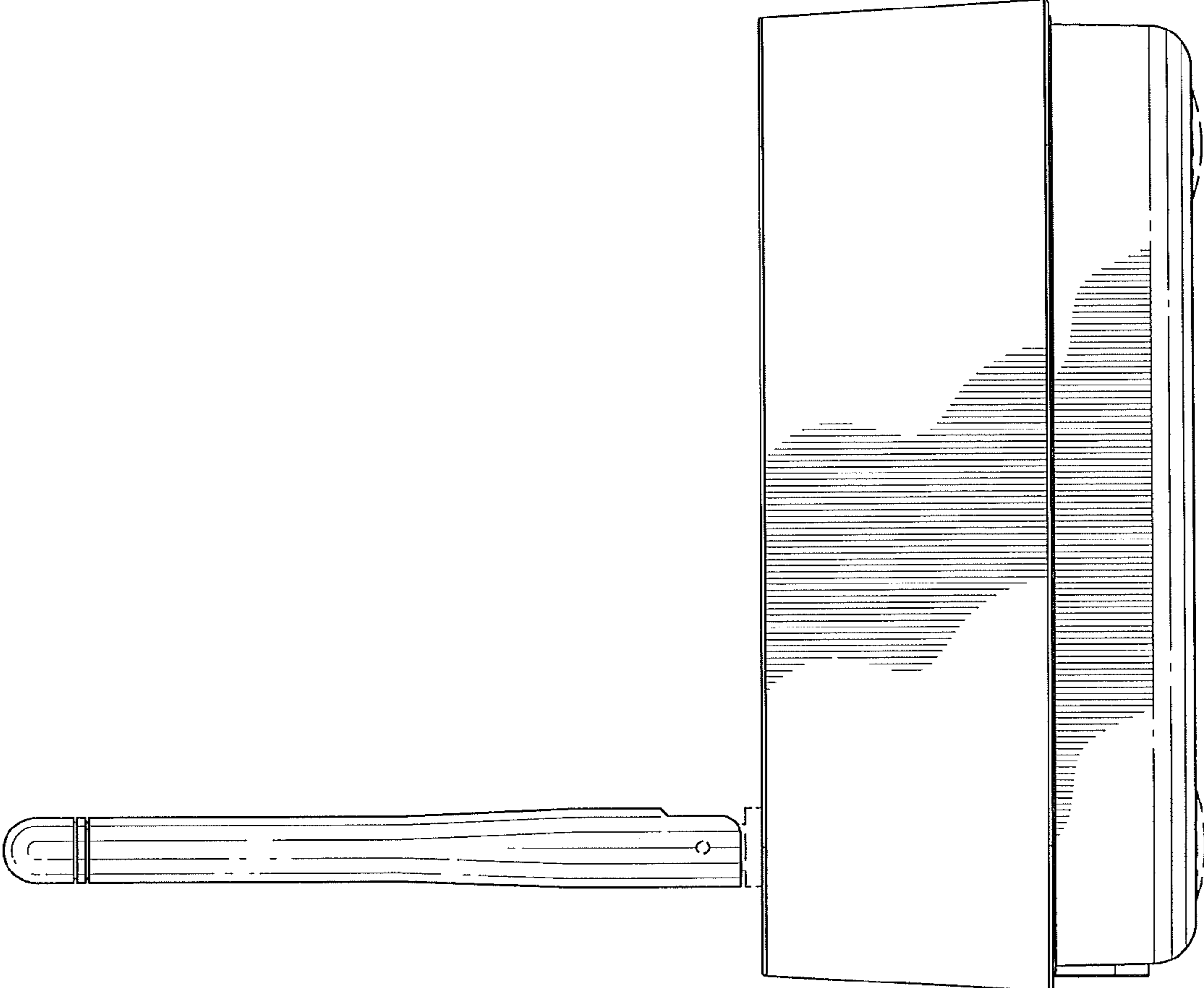

FIG. 2

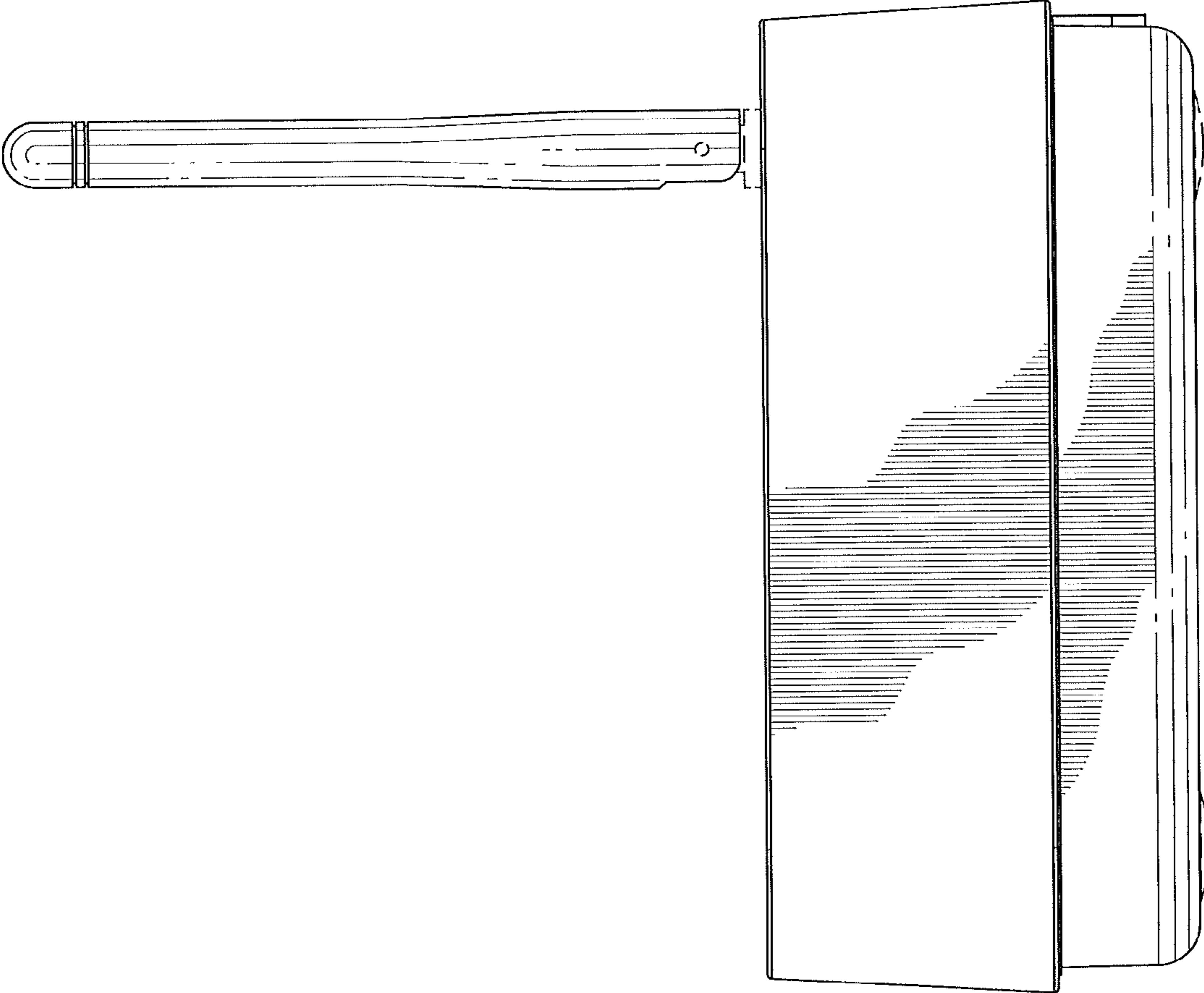

FIG.3

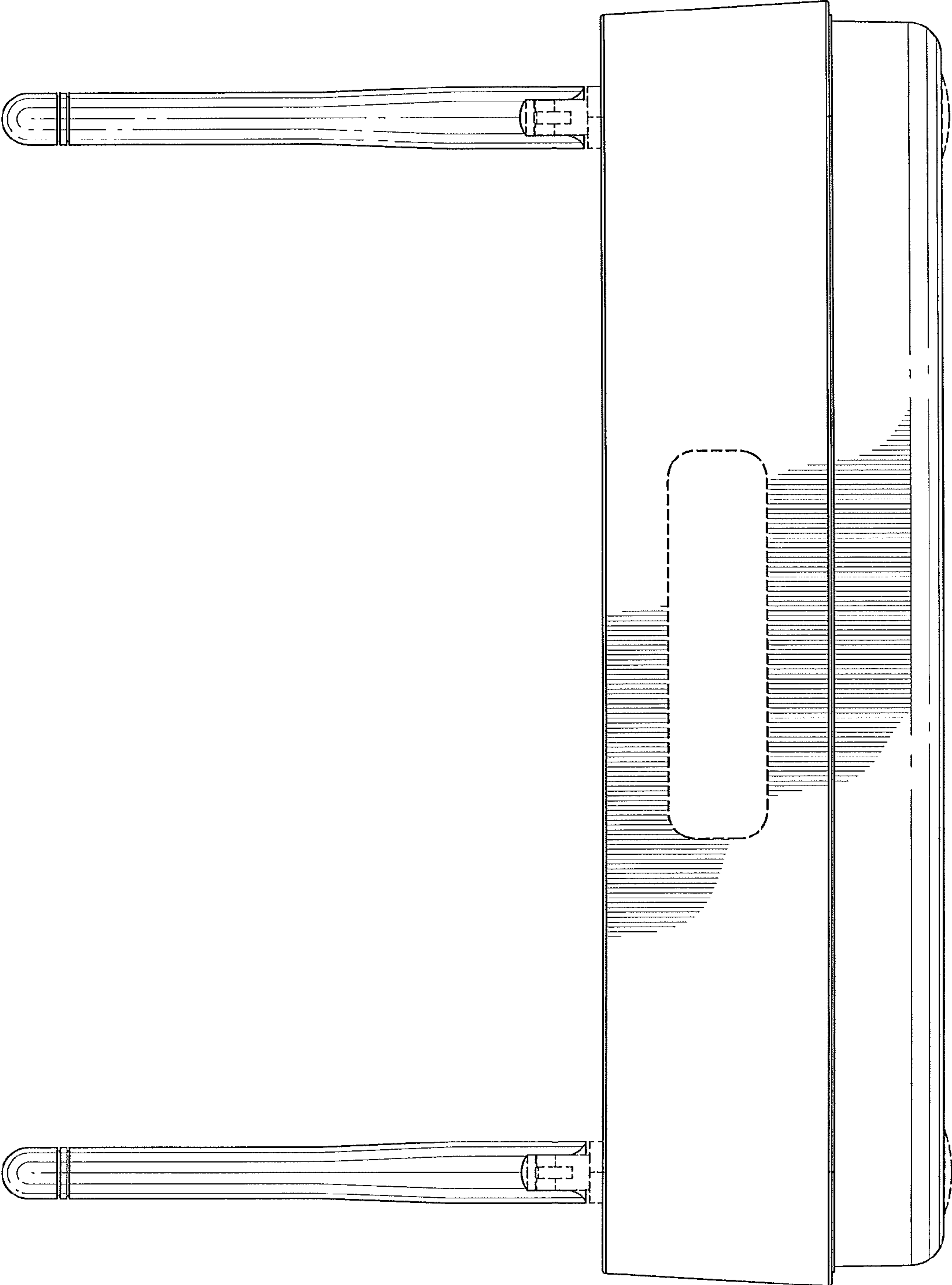

FIG.4

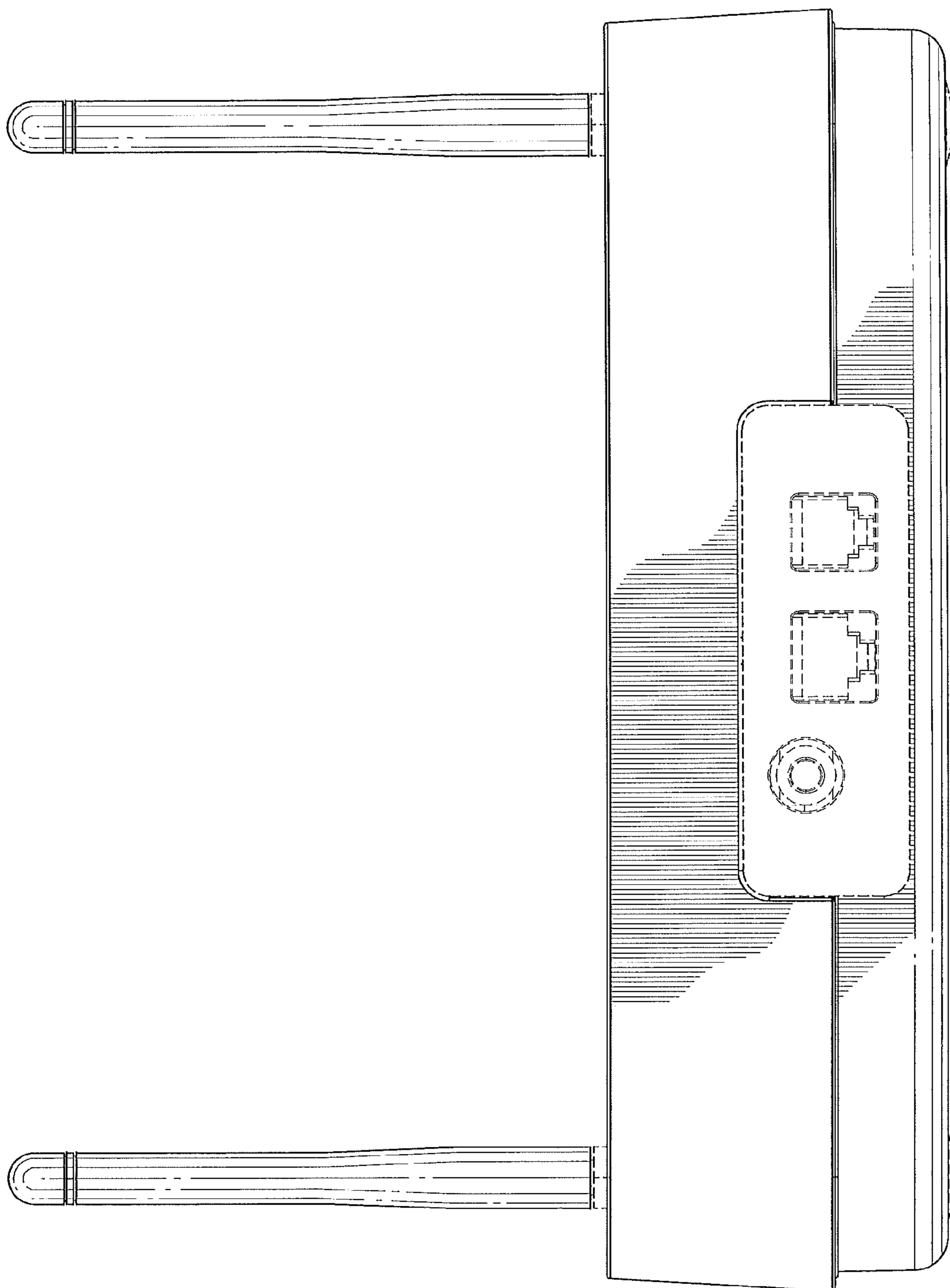

FIG. 5

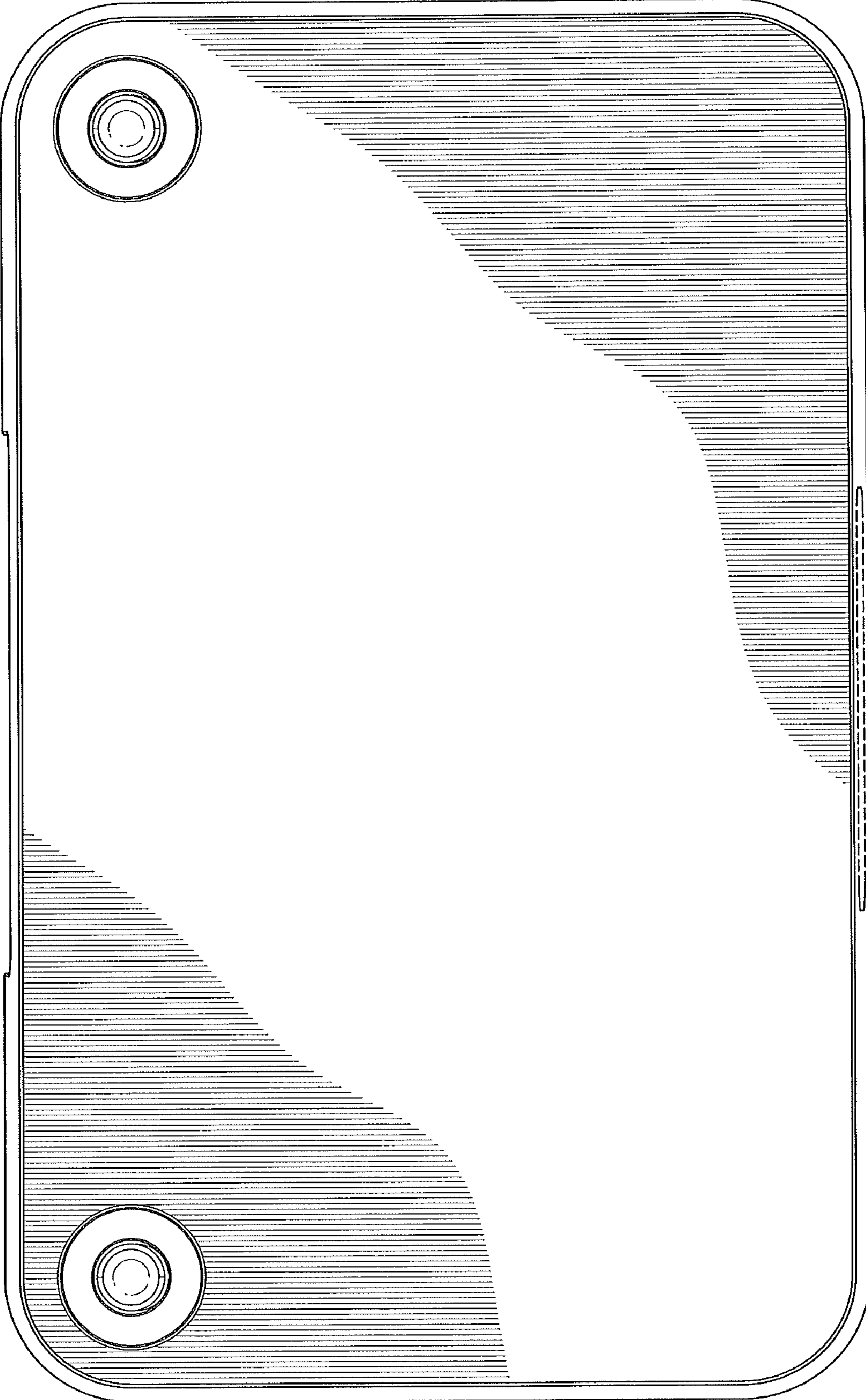

FIG. 6

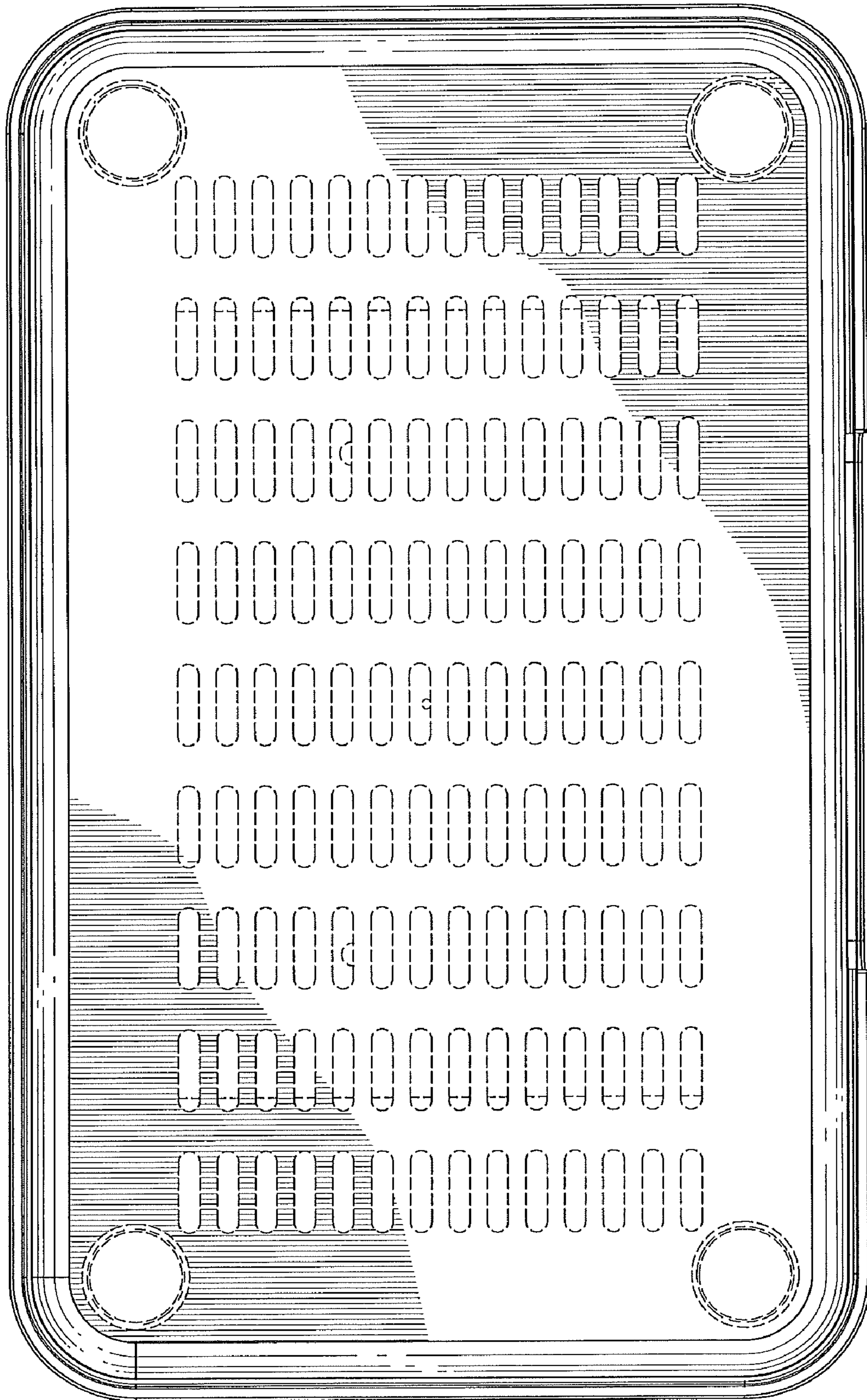

FIG. 7