



US00D601984S

(12) **United States Design Patent**
Kim et al.

(10) **Patent No.:** **US D601,984 S**
(45) **Date of Patent:** **** Oct. 13, 2009**

(54) **MOBILE PHONE**

(75) Inventors: **Kang-Moon Kim**, Seoul (KR);
Young-Ju Yeo, Seoul (KR); **Chang-Soo Lee**, Incheon (KR)

(73) Assignee: **Samsung Electronics Co., Ltd.**,
Suwon-Si (KR)

(**) Term: **14 Years**

(21) Appl. No.: **29/320,790**

(22) Filed: **Jul. 3, 2008**

(30) **Foreign Application Priority Data**

Mar. 27, 2008 (KR) 30-2008-0013164

(51) **LOC (9) Cl.** **14-03**

(52) **U.S. Cl.** **D14/138 AA**

(58) **Field of Classification Search** D14/137,
D14/138 R, 138 AA, 138 AB, 138 AC, 138 AD,
D14/138 C, 138 G, 147-148, 156, 191, 218,
D14/247-248, 341-347, 390, 399, 455-456,
D14/496; D10/65, 78, 104; D13/164, 168;
D16/208; D18/7; D21/329, 331, 333, 517;
343/702; 345/167, 168, 169; 348/14.01-14.02;
361/814; 379/433.01-433.13; 439/165;
455/90.3, 556.1-556.2, 566, 575.1, 575.3,
455/575.4

See application file for complete search history.

(56) **References Cited**

U.S. PATENT DOCUMENTS

D525,229 S * 7/2006 Friesen et al. D14/138 AA
D532,767 S * 11/2006 Yoshino et al. D14/138 AA
D548,217 S * 8/2007 Choi et al. D14/138 AA
D550,193 S * 9/2007 Kim et al. D14/138 AA
D555,617 S * 11/2007 Yang et al. D14/138 AA
D556,170 S * 11/2007 Lee et al. D14/138 AA
D557,246 S * 12/2007 Kim et al. D14/138 AA
D559,219 S * 1/2008 Suk et al. D14/138 AA
D562,282 S * 2/2008 Suk et al. D14/138 AA
D569,858 S 5/2008 He

D572,693 S * 7/2008 Miake D14/138 AA
D576,992 S * 9/2008 Kim et al. D14/138 AA
D576,993 S 9/2008 Park et al.
D578,101 S * 10/2008 Park et al. D14/138 AA
2006/0105806 A1 * 5/2006 Vance et al. 455/556.1

FOREIGN PATENT DOCUMENTS

JP D1239145 5/2005
TW D118696 8/2007
TW D125178 10/2008

OTHER PUBLICATIONS

Sony Ericsson K200 , announced Feb. 2007, <URL:http://www.gsmarena.com/sony_ericsson_k200-pictures-1842.php>, retrieved from internet Jun. 5, 2009.*

LG KG130, announced Apr. 2007, URL:http://www.gsmarena.com/lg_kg130-pictures-2063.php>, retrieved from internet Jun. 5, 2009.*

Samsung S7220 Ultra b, announced Feb. 2009, <URL:http://www.gsmarena.com/samsung_s7220_ultra_b-pictures-2695.php>, retrieved from internet Jun. 5, 2009.*

Taiwanese Notification for Examination issued on Mar. 4, 2009 in corresponding Taiwanese Patent Application 097303139.

Taiwanese Search Report issued on Mar. 4, 2009 in corresponding Taiwanese Patent Application 097303139.

* cited by examiner

Primary Examiner—Ian Simmons

Assistant Examiner—Carla Wright

(74) *Attorney, Agent, or Firm*—Staas & Halsey LLP

(57) **CLAIM**

The ornamental design for a mobile phone, as shown and described.

DESCRIPTION

FIG. 1 is a front perspective view of a mobile phone;

FIG. 2 is a front view of the mobile phone of FIG. 1;

FIG. 3 is a rear view of the mobile phone of FIG. 1;

FIG. 4 is a left-side view of the mobile phone of FIG. 1;

FIG. 5 is a right-side view of the mobile phone of FIG. 1;

FIG. 6 is a top plan view of the mobile phone of FIG. 1; and,

FIG. 7 is a bottom plan view of the mobile phone of FIG. 1.

1 Claim, 5 Drawing Sheets

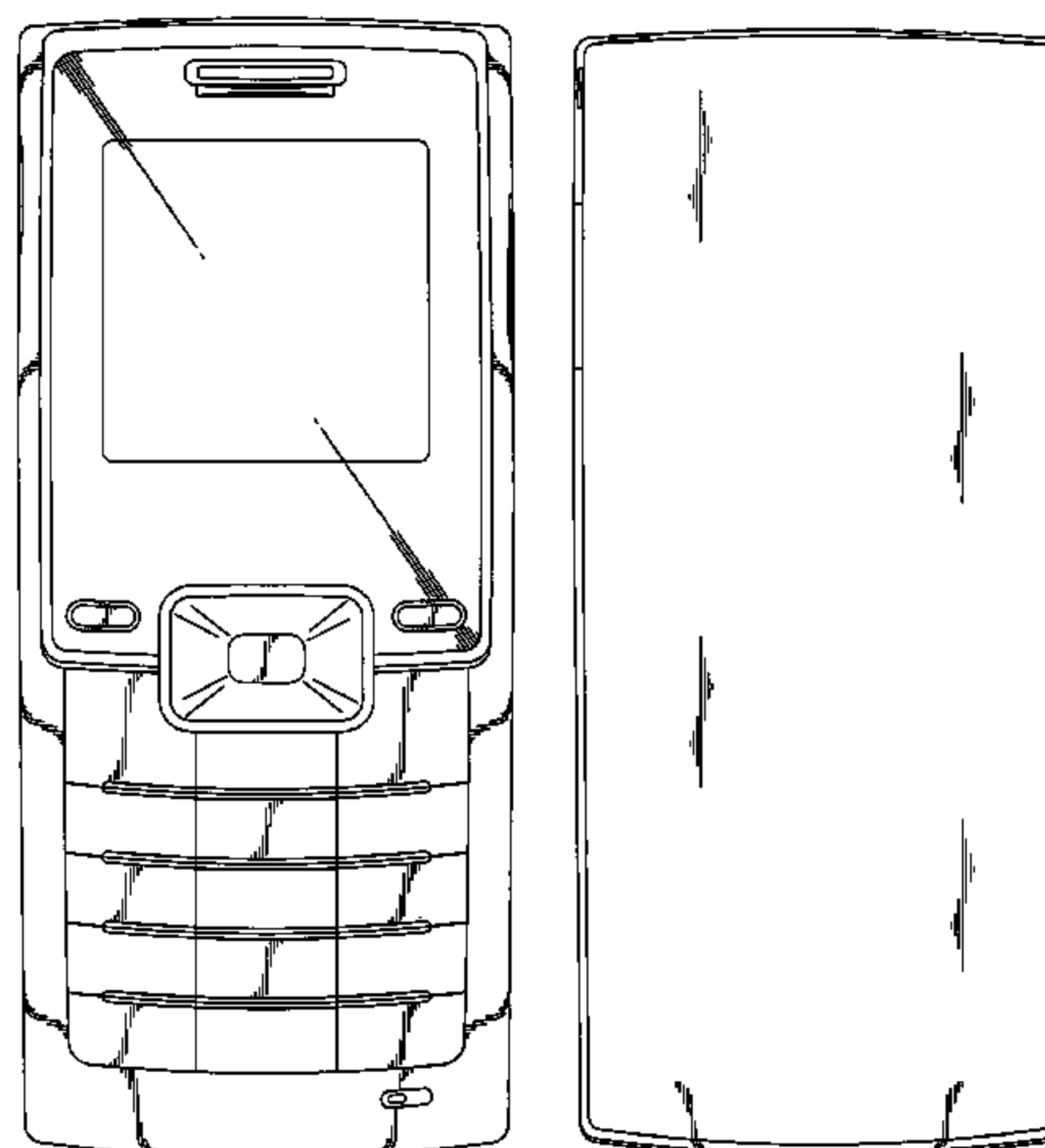

FIG. 1

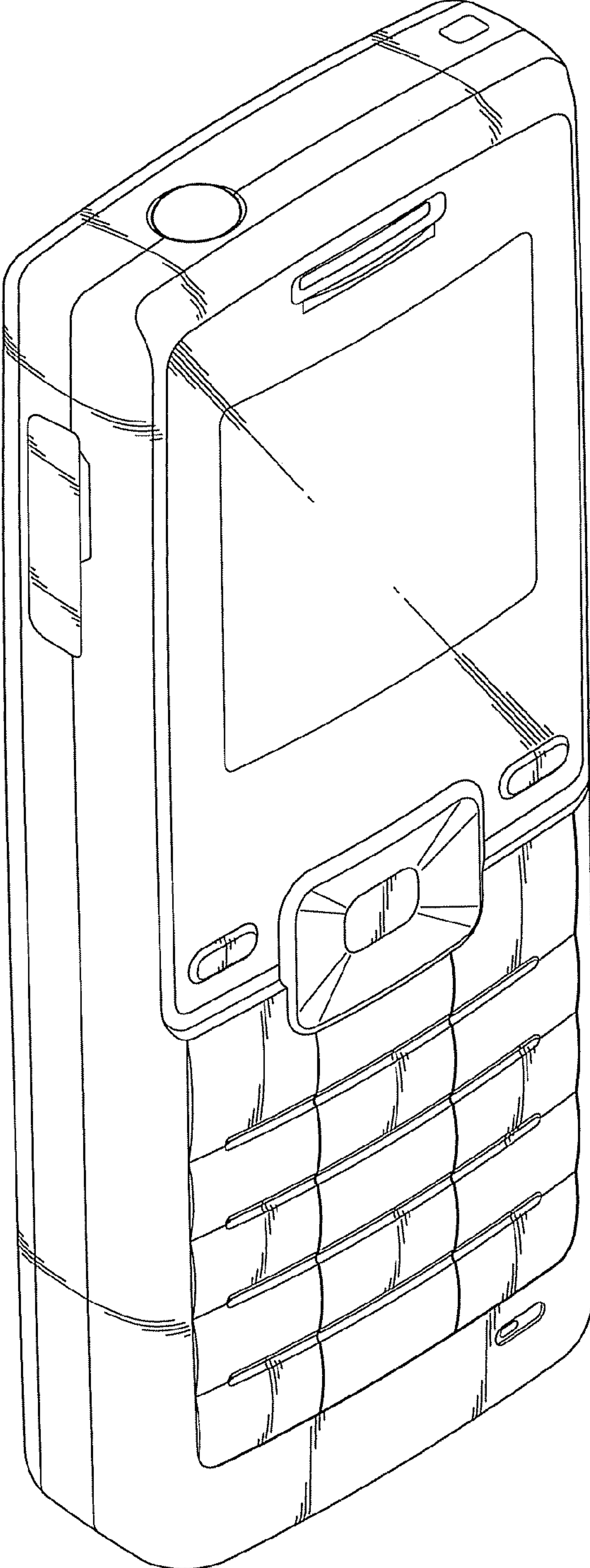

FIG.2

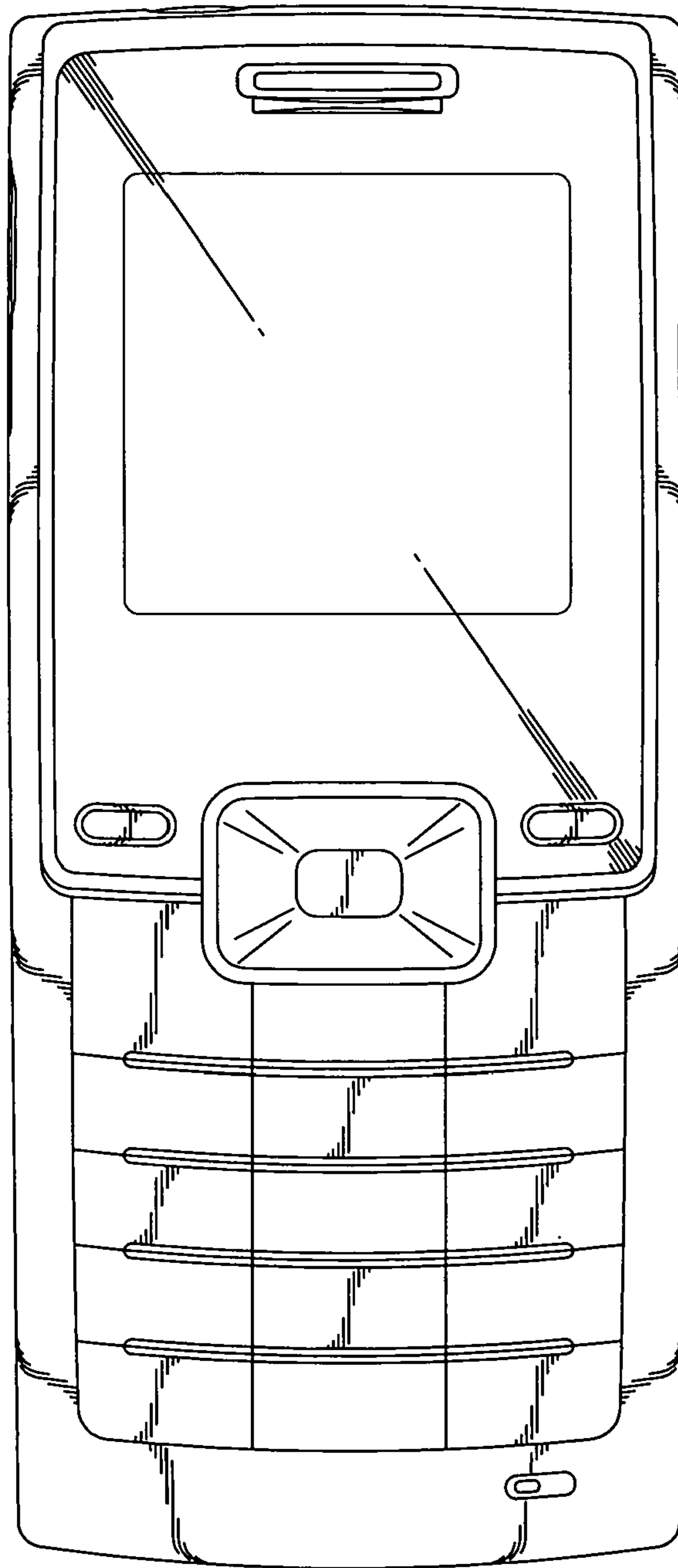

FIG.3

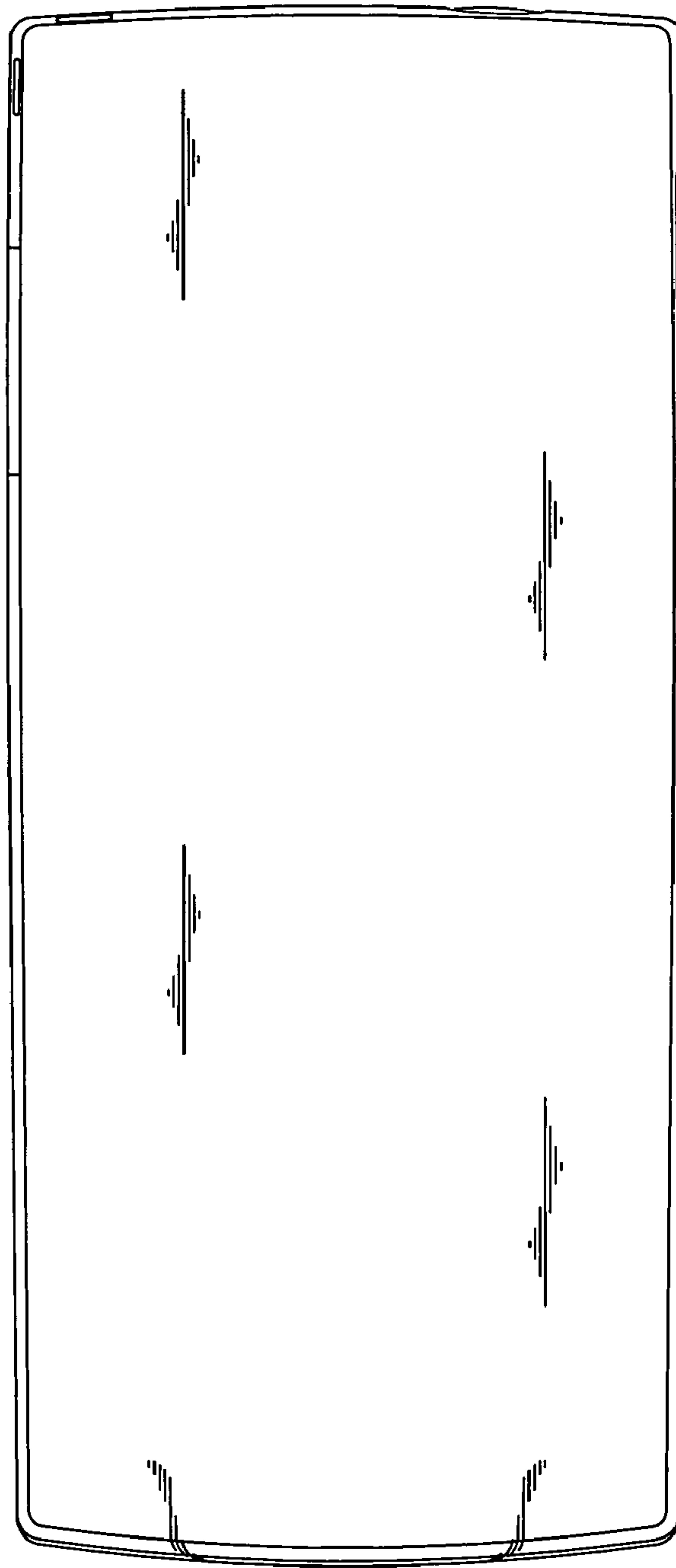

FIG. 4

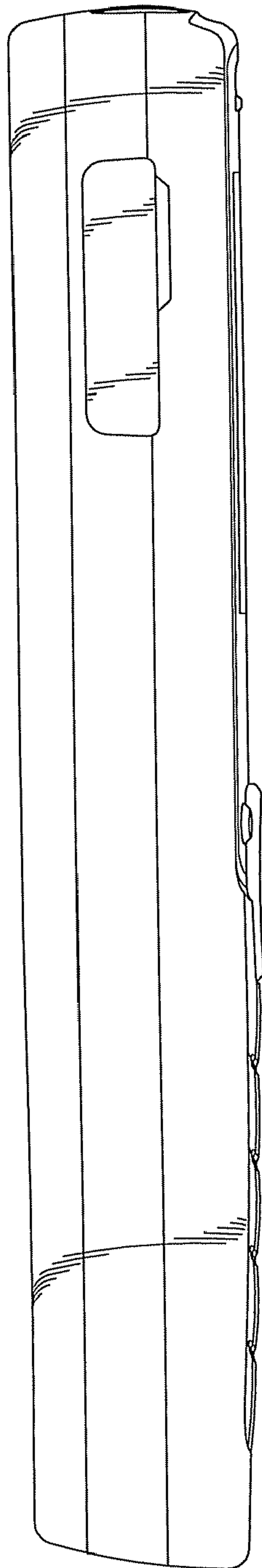

FIG. 5

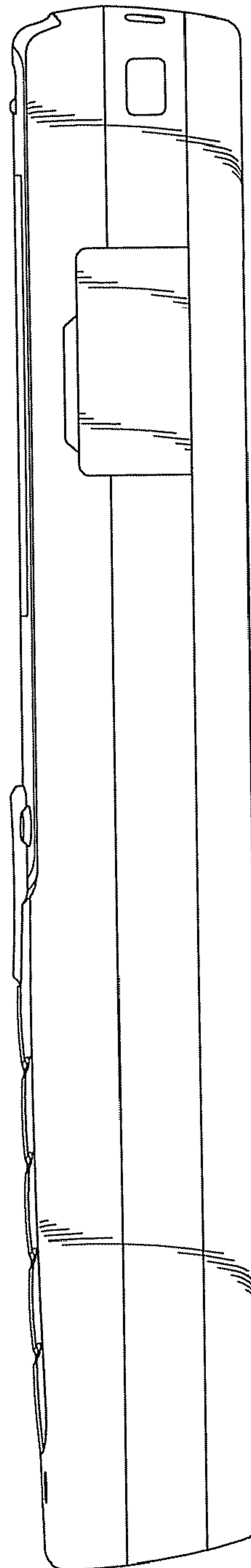

FIG.6

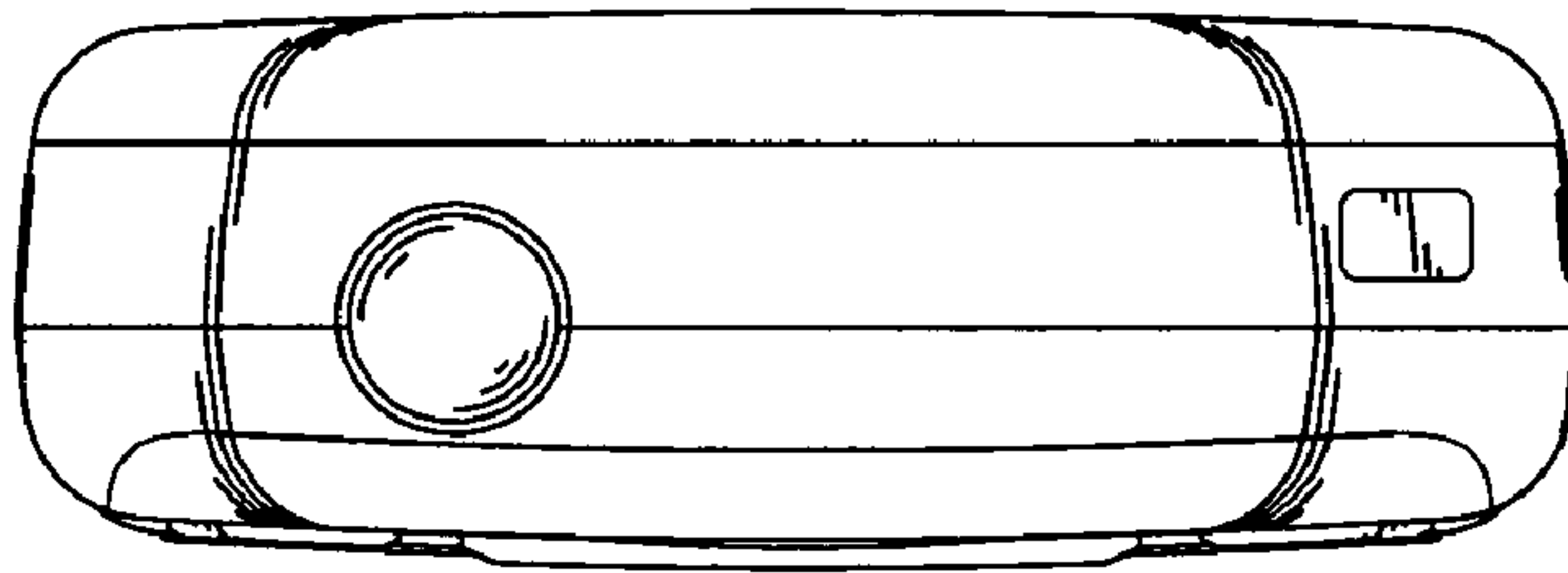

FIG.7

