



US00D601848S

(12) **United States Design Patent**  
**Borin**

(10) **Patent No.:** **US D601,848 S**

(45) **Date of Patent:** **\*\* Oct. 13, 2009**

(54) **COFFEE MACHINE**

(75) Inventor: **Giacomo Borin**, Pordenone (IT)

(73) Assignee: **De'Longhi S.p.A.**, Treviso (IT)

(\*\*) Term: **14 Years**

(21) Appl. No.: **29/331,266**

(22) Filed: **Jan. 22, 2009**

**Related U.S. Application Data**

(62) Division of application No. 29/292,693, filed on Oct. 24, 2007, now Pat. No. Des. 586,603.

(30) **Foreign Application Priority Data**

Apr. 26, 2007 (EM) ..... 713516

(51) **LOC (9) Cl.** ..... **07-01**

(52) **U.S. Cl.** ..... **D7/309; D7/311; D7/307**

(58) **Field of Classification Search** ..... D7/300,  
D7/305-312; 99/299, 284, 280, 283, 300;  
219/433

See application file for complete search history.

(56) **References Cited**

**U.S. PATENT DOCUMENTS**

D445,292 S	7/2001	Sowden	
D486,346 S	2/2004	Jonsson	
D524,588 S *	7/2006	Copland	D7/309
D526,524 S *	8/2006	Jordana	D7/309
D536,917 S *	2/2007	McWilliam	D7/309
D553,897 S *	10/2007	De' Longhi	D7/309
D563,143 S *	3/2008	Tonelli	D7/306
D568,665 S	5/2008	Tonelli	
D570,636 S	6/2008	Kulujian et al.	

D574,174 S	8/2008	Tonelli	
D584,096 S *	1/2009	Lutz	D7/307
D586,603 S *	2/2009	Borin	D7/309
D587,511 S *	3/2009	Buttler	D7/309

\* cited by examiner

*Primary Examiner*—Marianne Pandozzi

(74) *Attorney, Agent, or Firm*—Hamre, Schumann, Mueller & Larson, P.C.

(57) **CLAIM**

The ornamental design for a coffee machine, as shown and described.

**DESCRIPTION**

FIG. 1 is a perspective of a coffee machine in accordance with a first embodiment of my design;

FIG. 2 is a front view thereof;

FIG. 3 is a left side view thereof;

FIG. 4 is a right side view thereof;

FIG. 5 is a back view thereof;

FIG. 6 is a top view thereof;

FIG. 7 is a bottom view thereof;

FIG. 8 is a perspective of a coffee machine in accordance with a second embodiment of my design;

FIG. 9 is a front view thereof;

FIG. 10 is a left side view thereof;

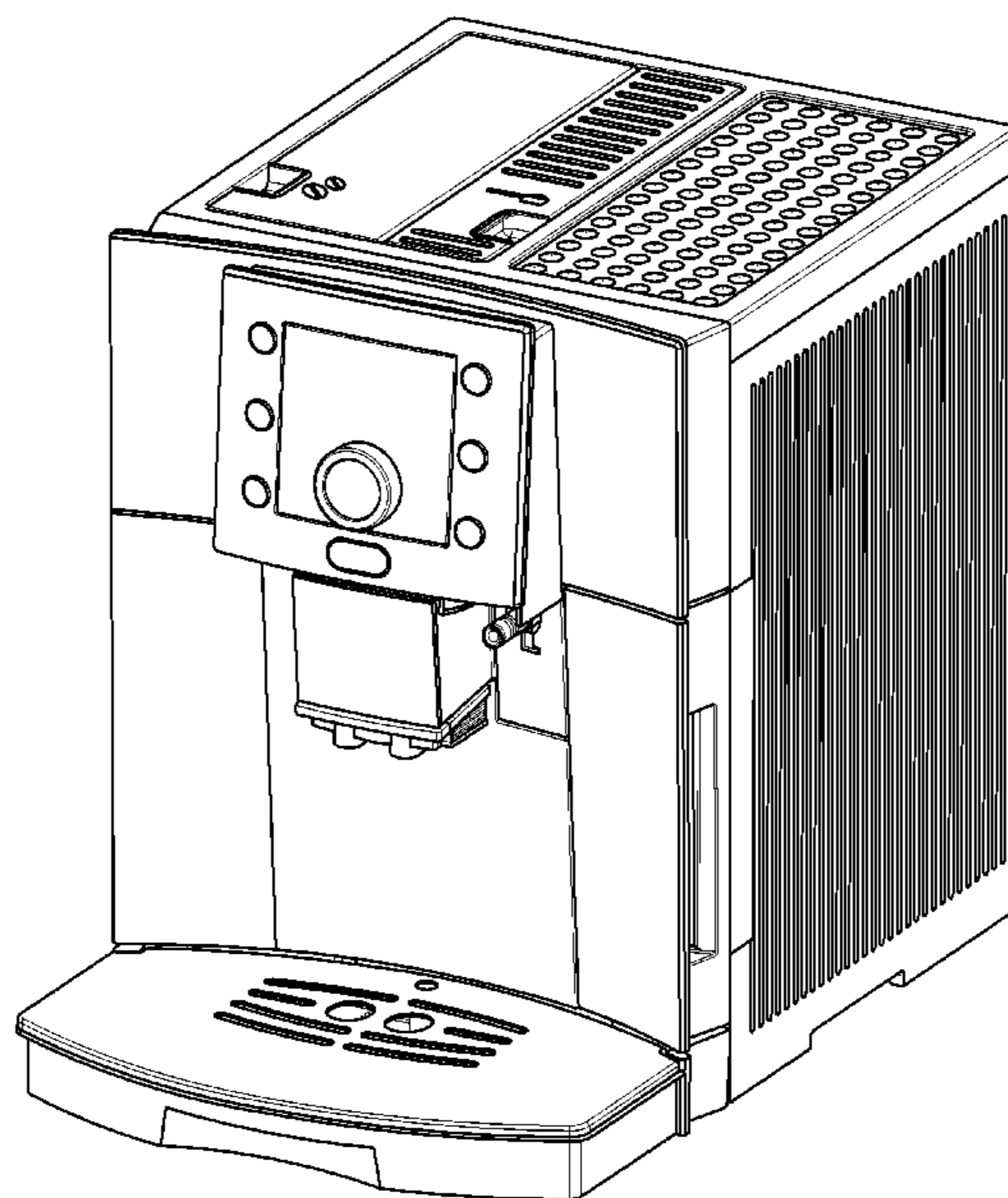
FIG. 11 is a right side view thereof;

FIG. 12 is a back view thereof;

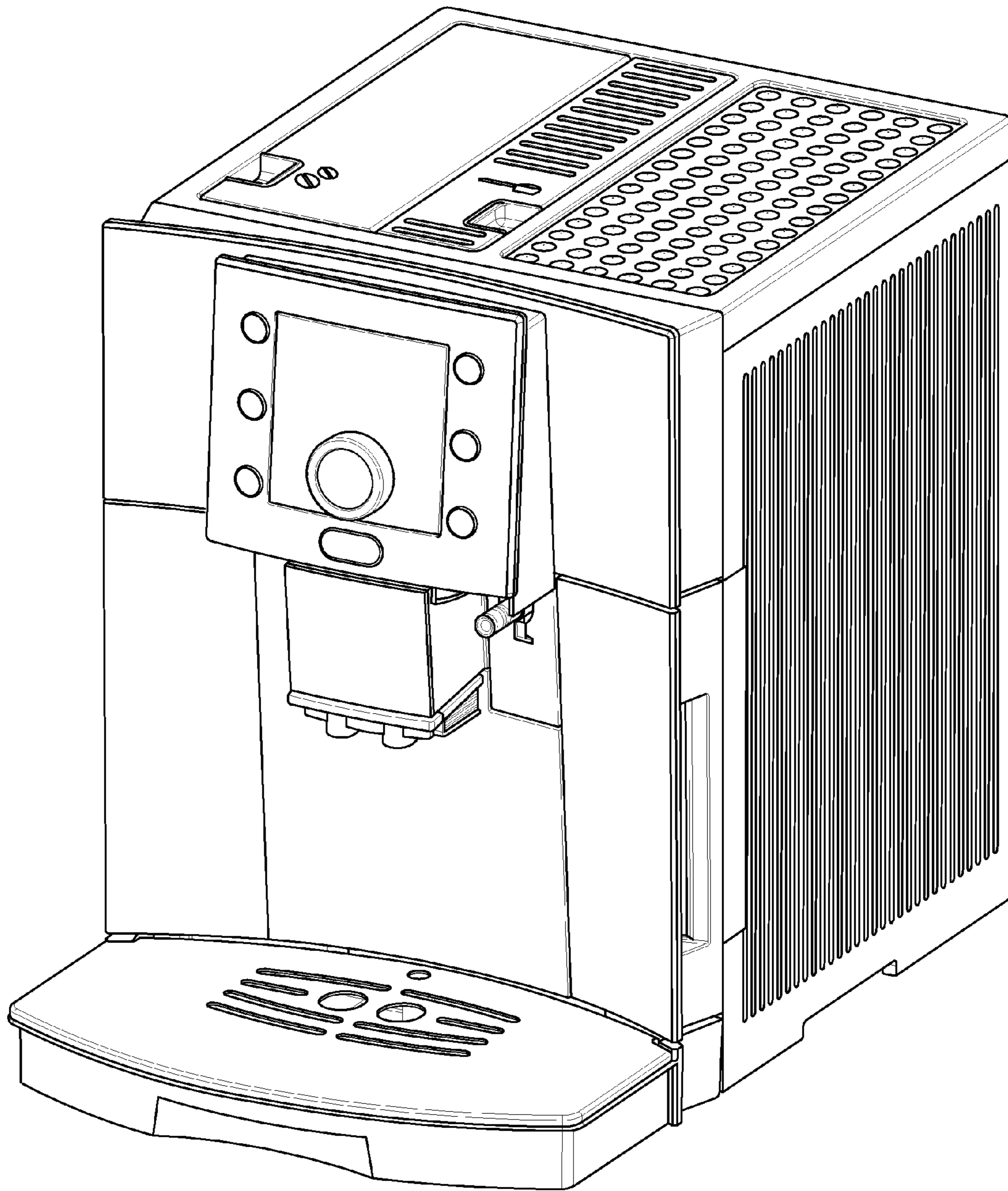
FIG. 13 is a top view thereof; and,

FIG. 14 is a bottom view thereof.

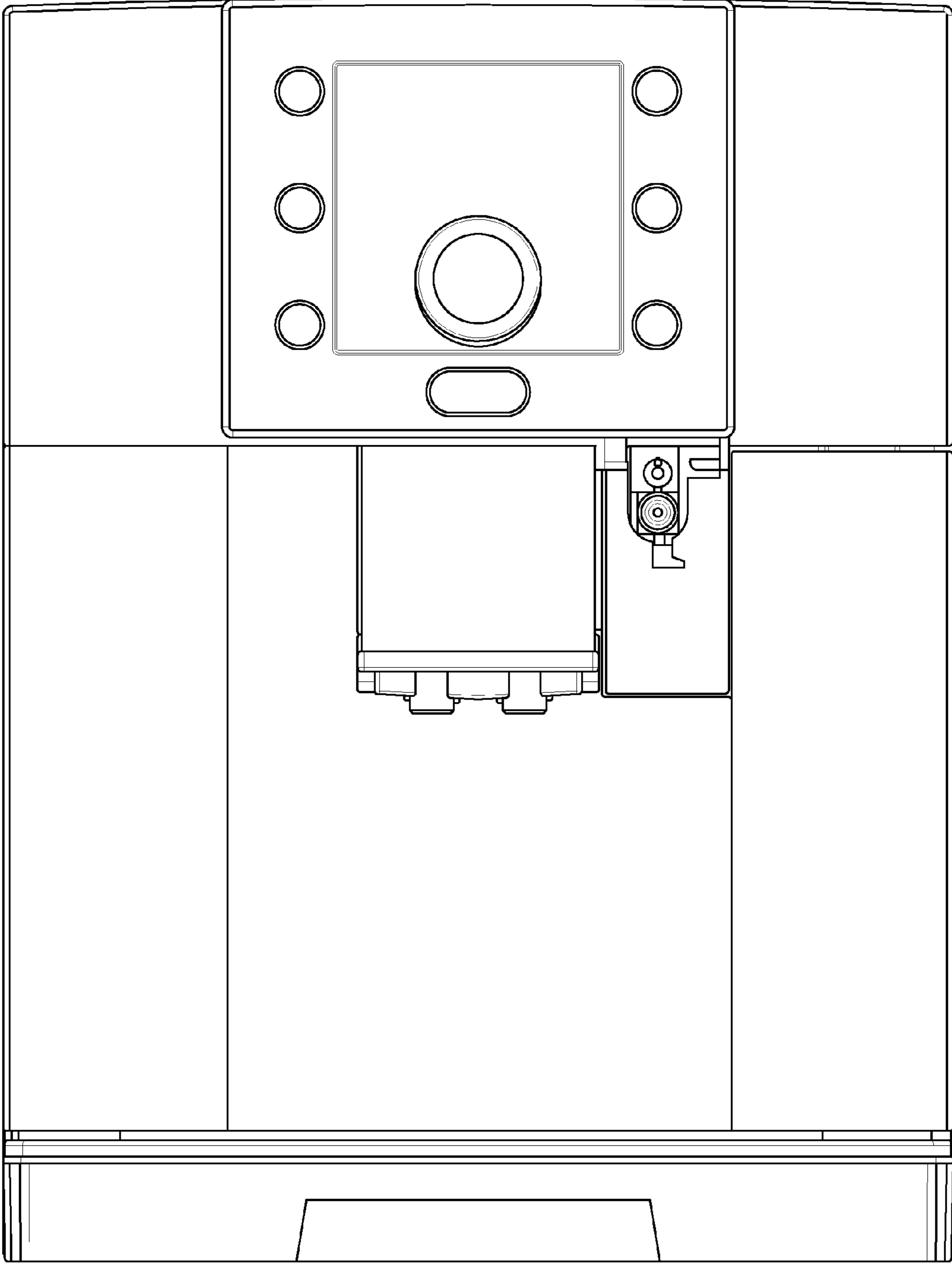
**1 Claim, 14 Drawing Sheets**

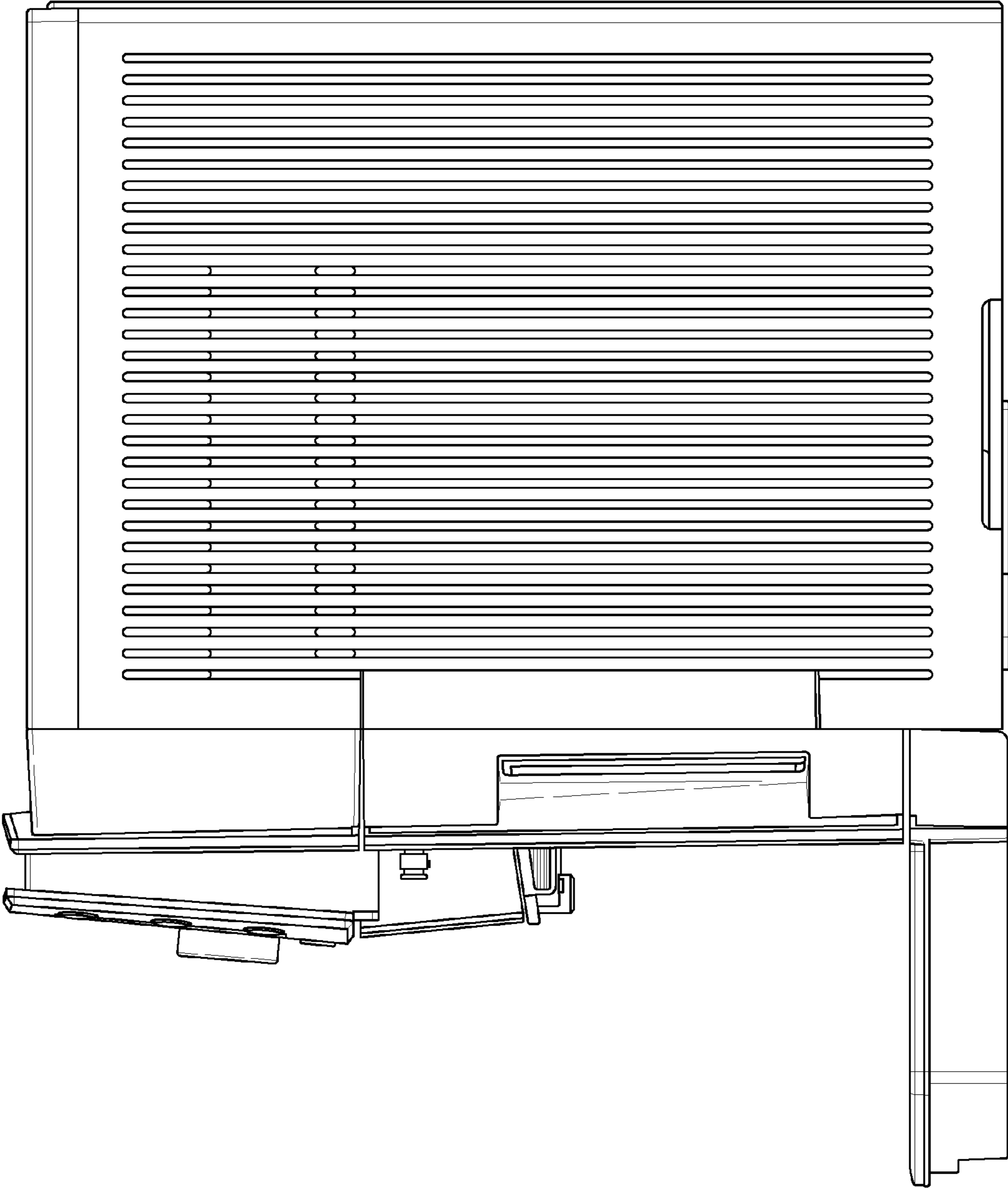


*Fig. 1*

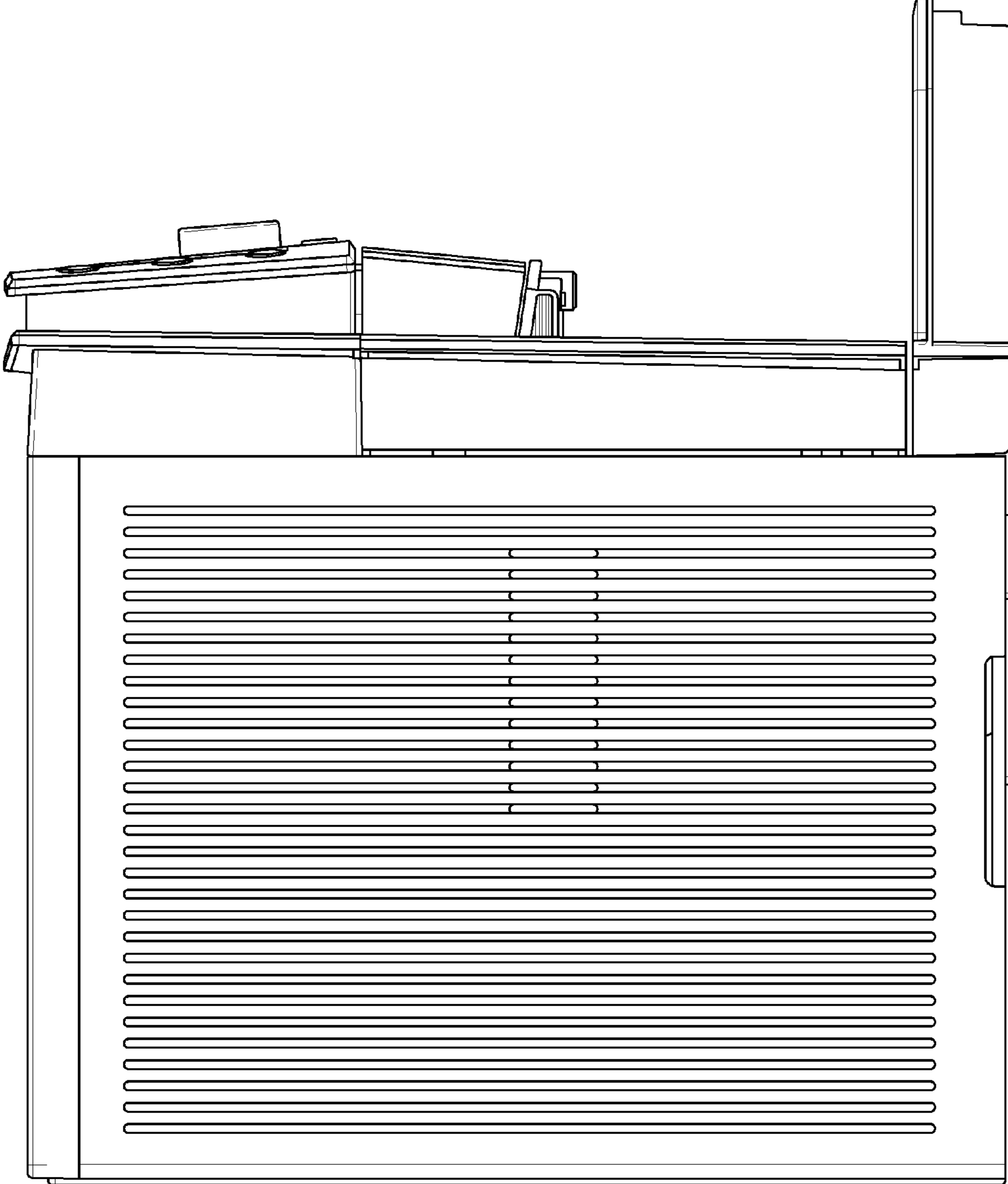


*Fig. 2*



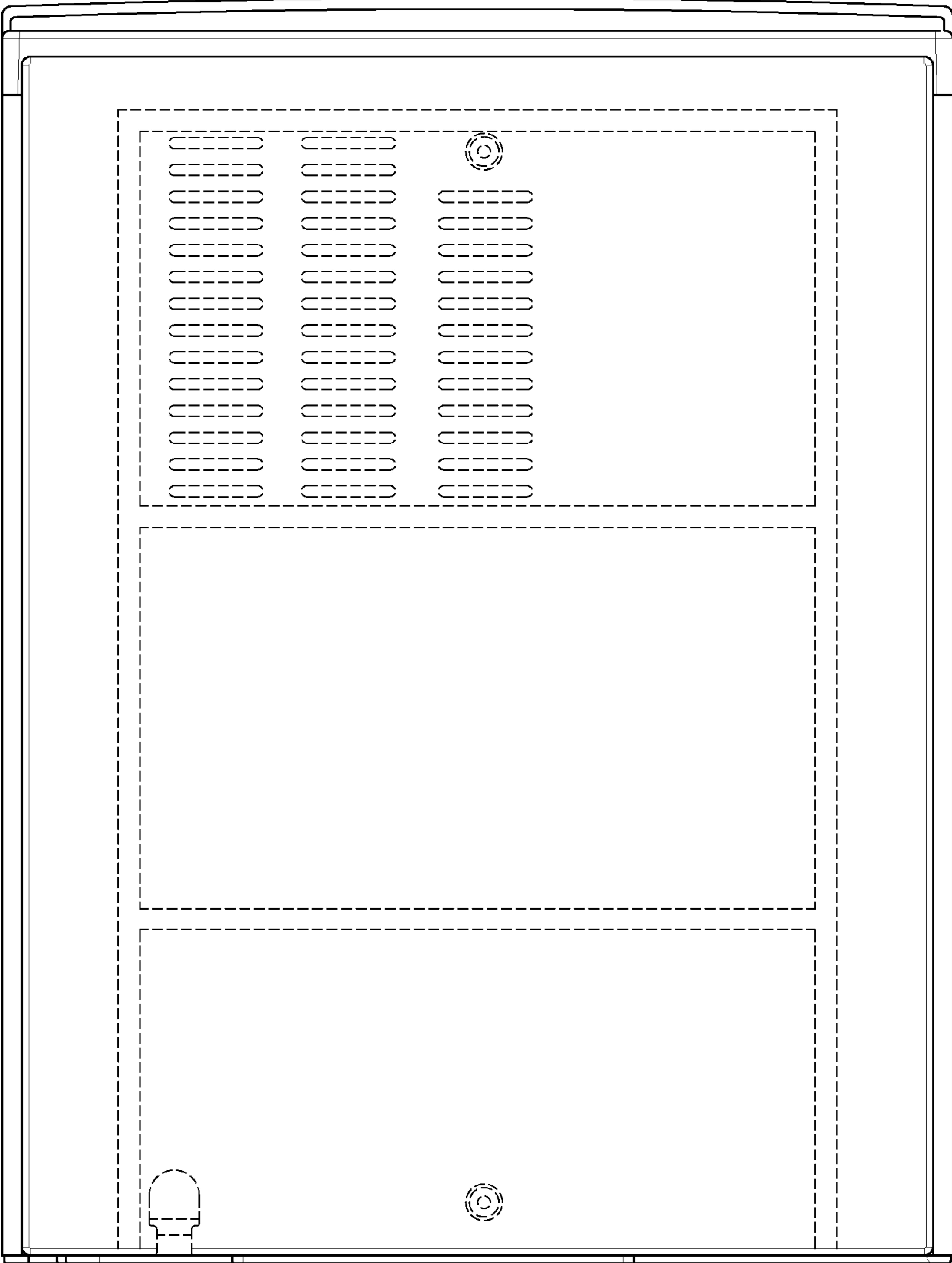


*Fig. 3*

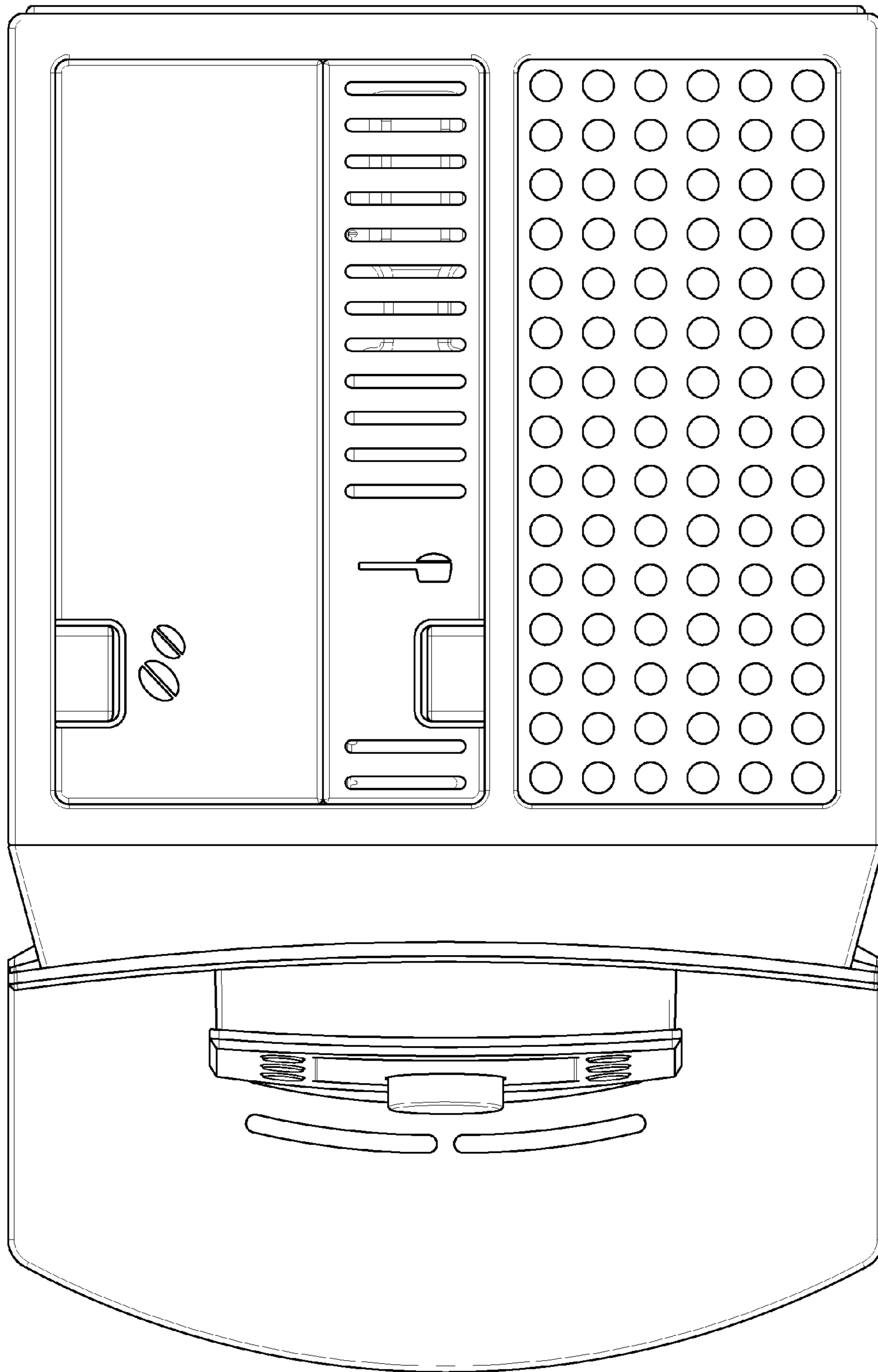


*Fig. 4*

*Fig. 5*

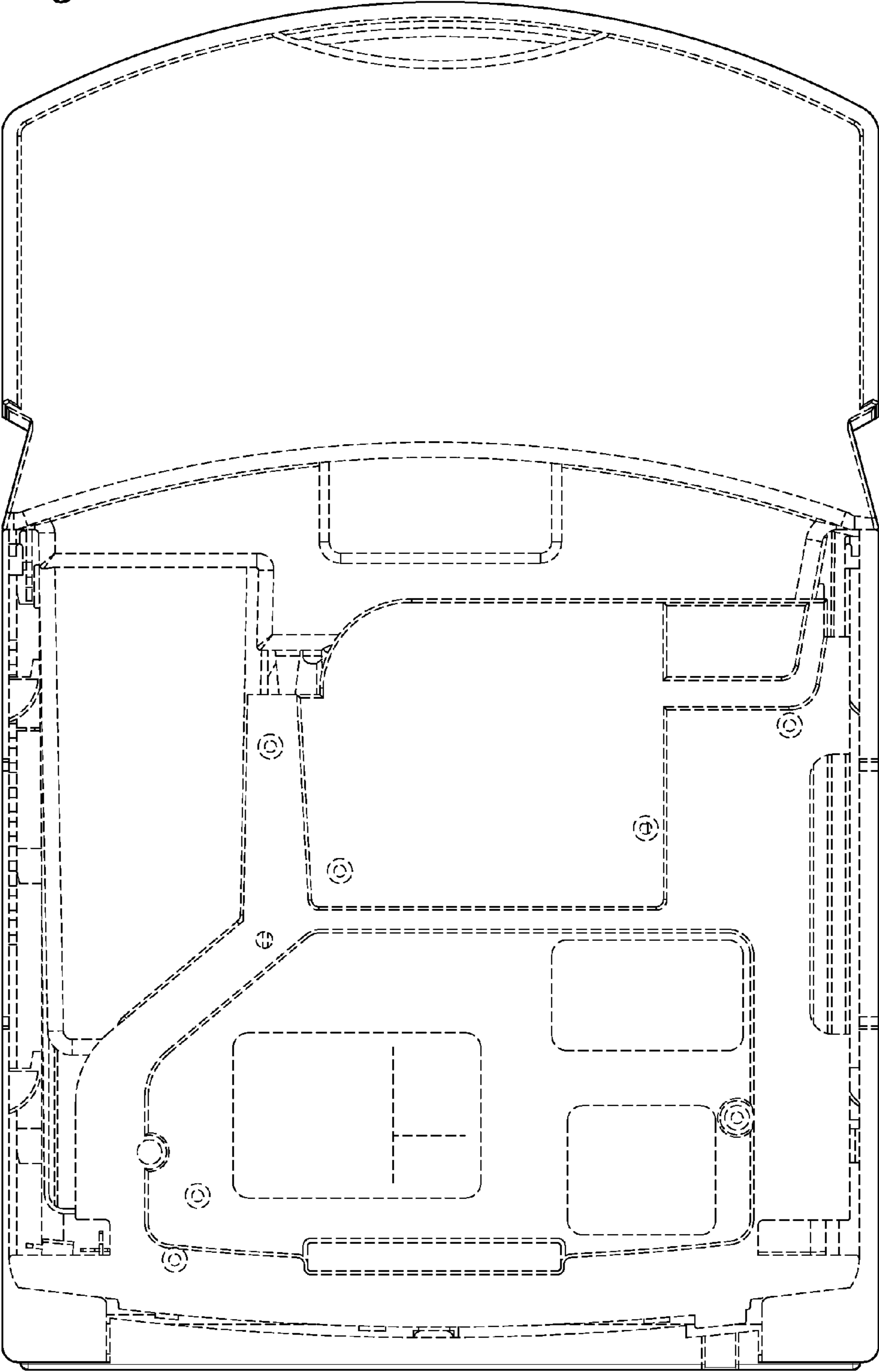


*Fig. 6*



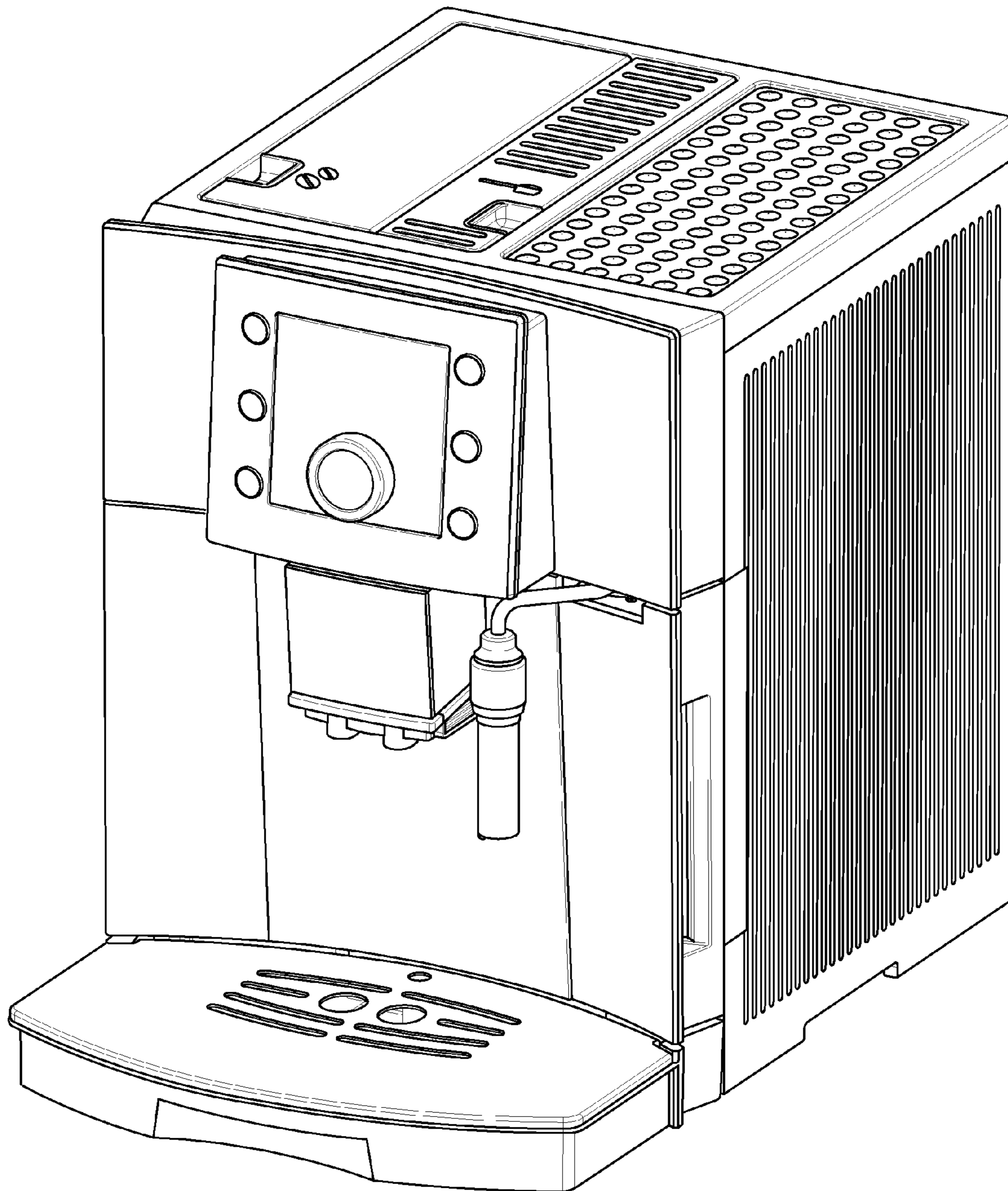


*Fig. 7*

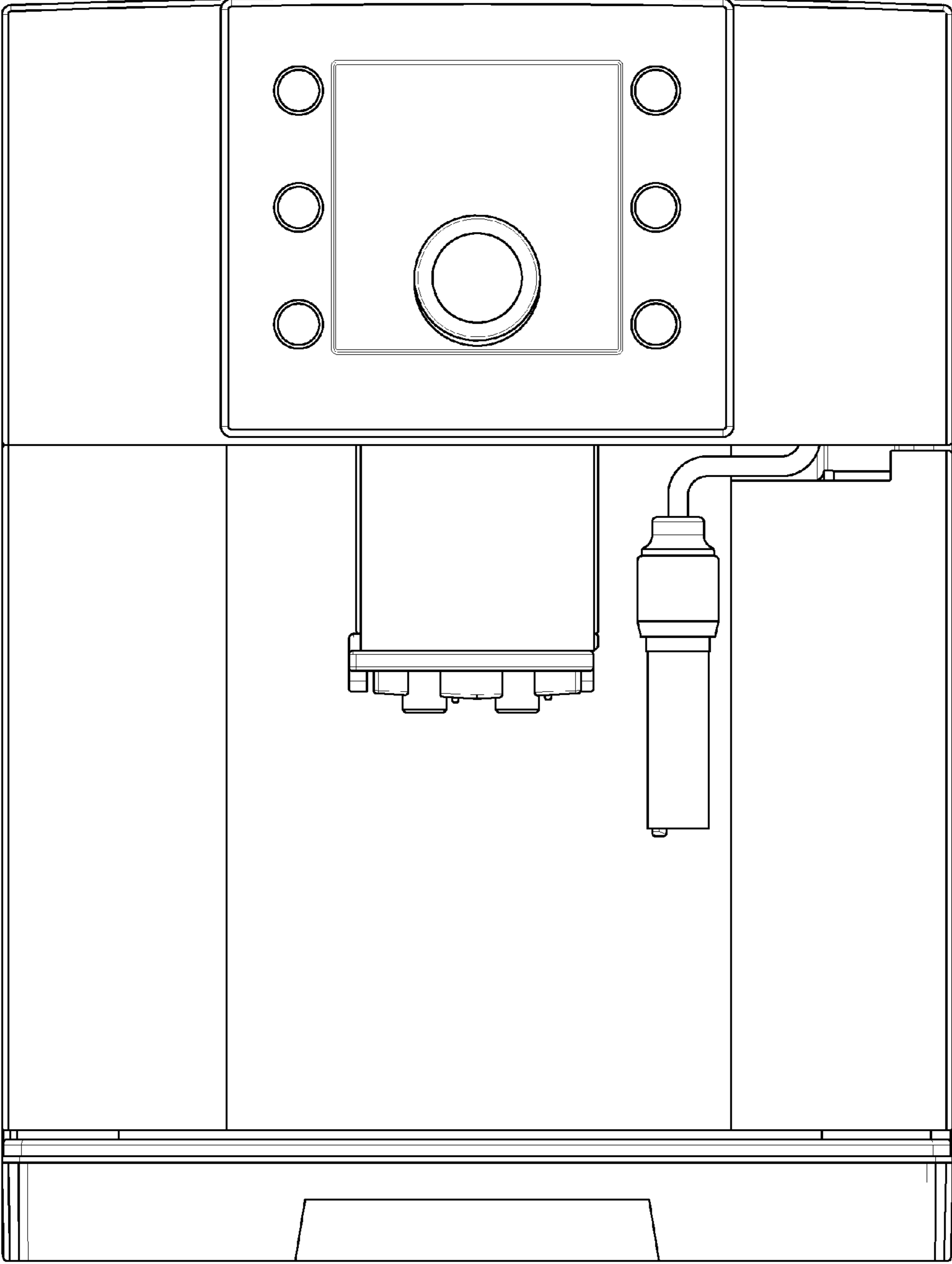


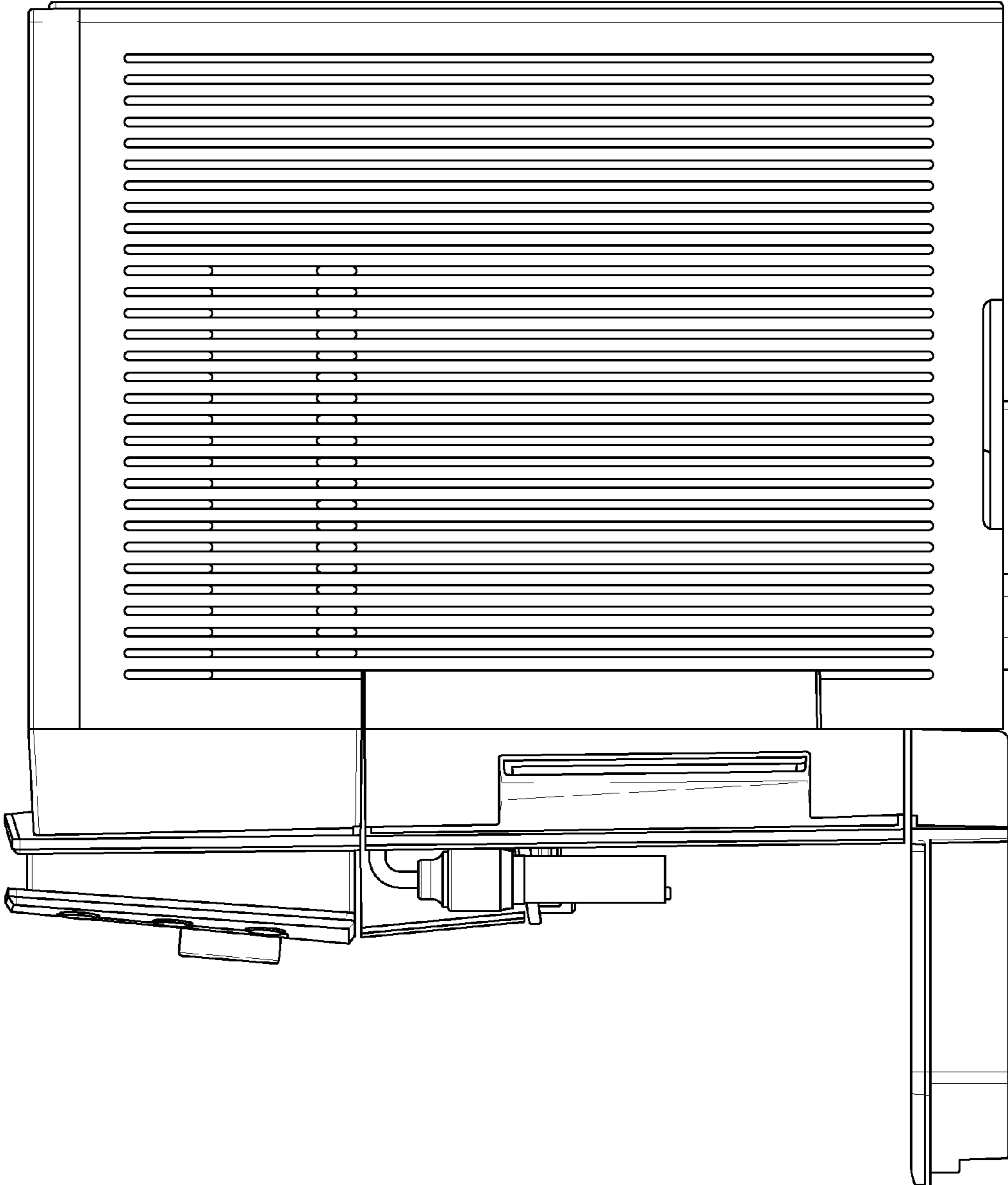


*Fig. 8*

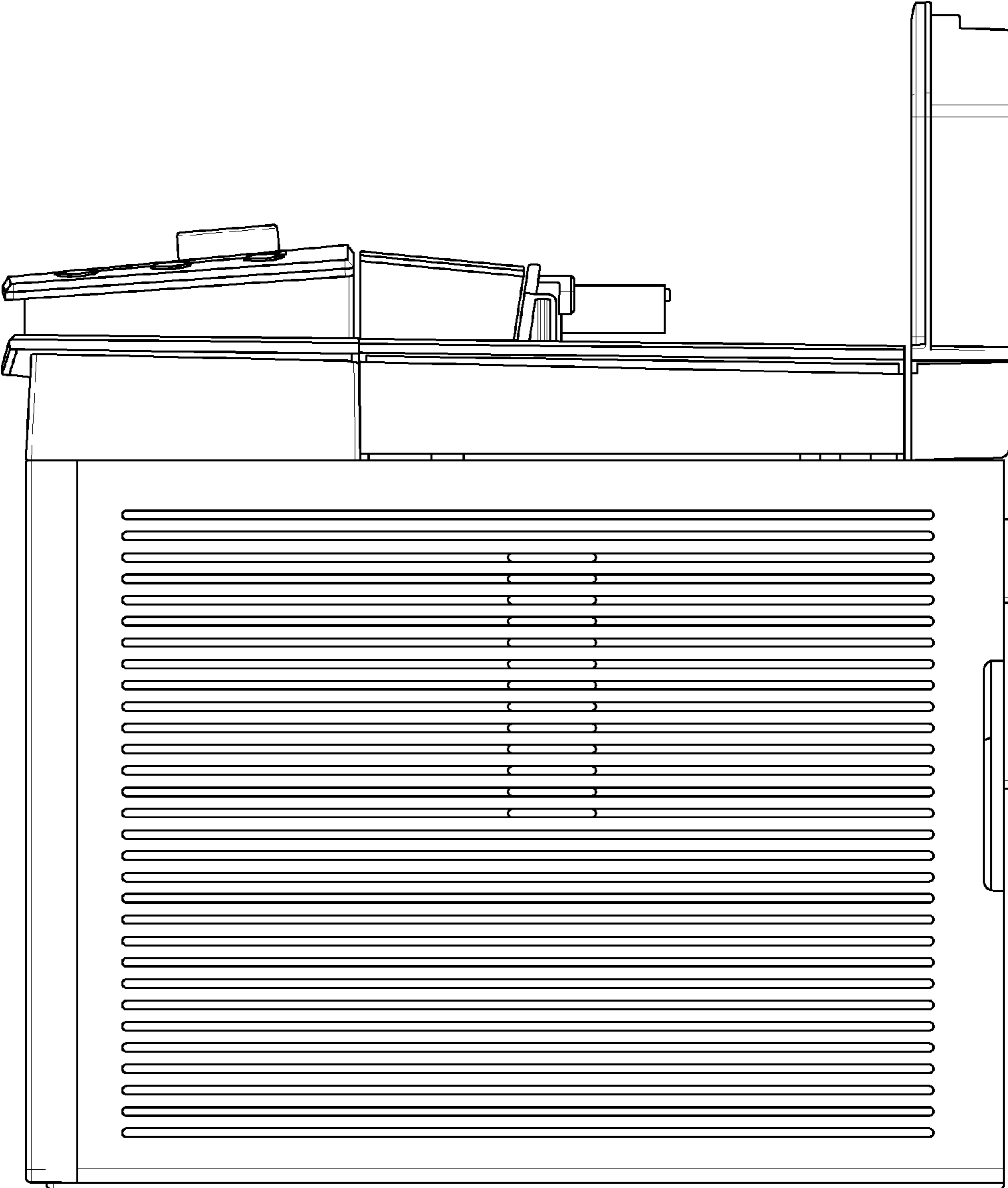


*Fig. 9*



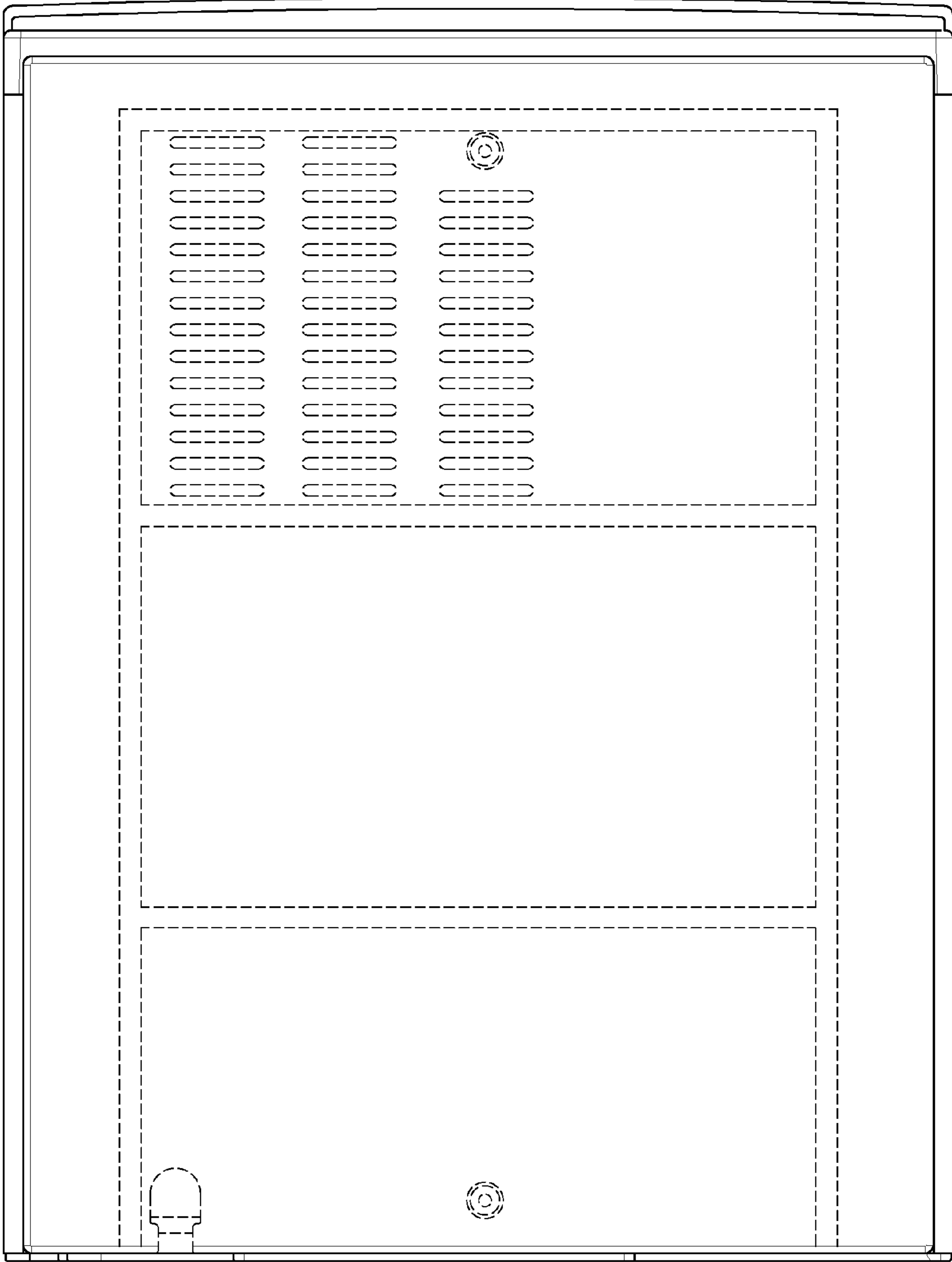


*Fig. 10*

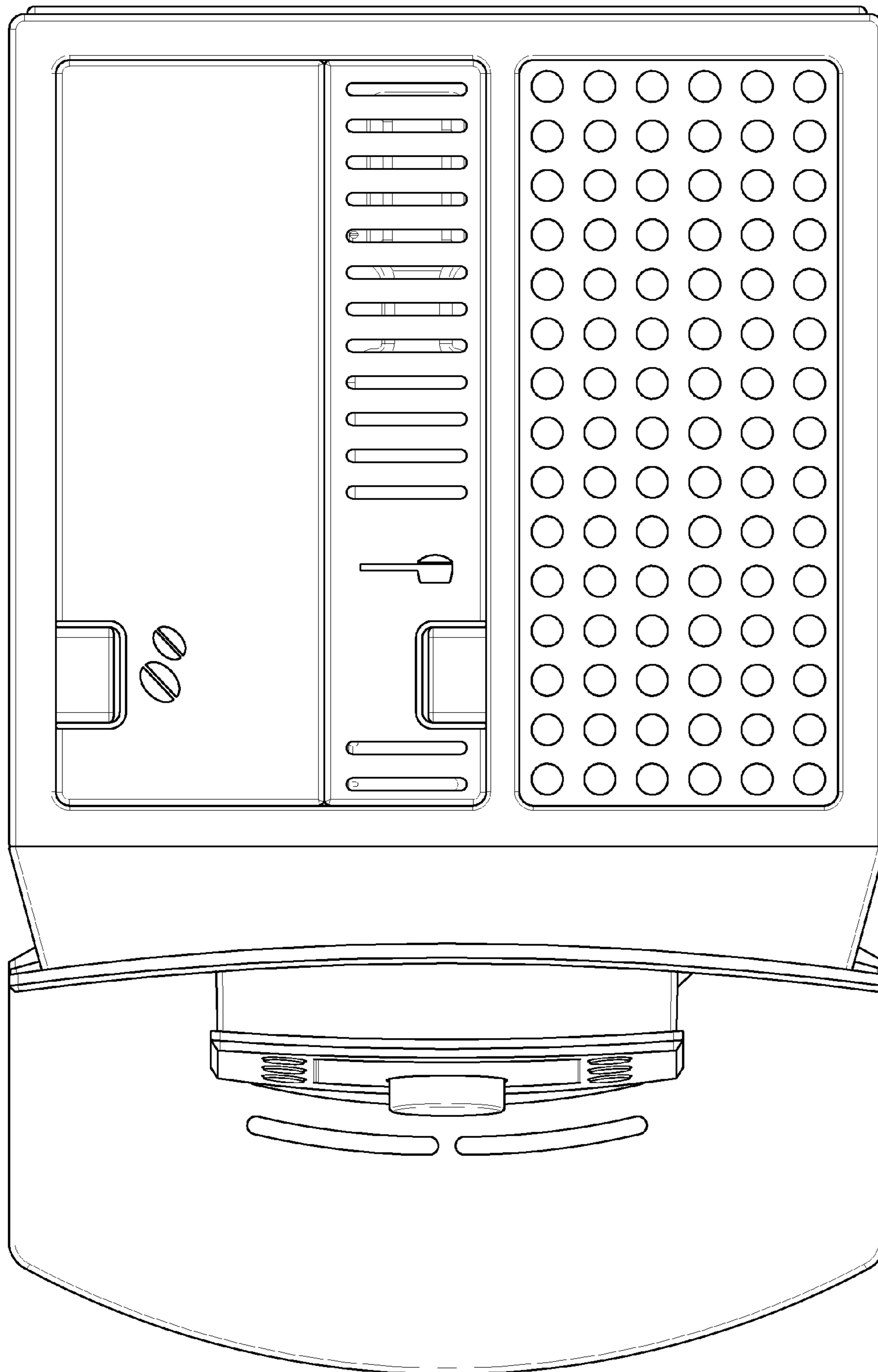


*Fig. 11*

*Fig. 12*



*Fig. 13*



*Fig. 14*

