



US00D601830S

(12) **United States Design Patent**  
**Egger**

(10) **Patent No.:** **US D601,830 S**

(45) **Date of Patent:** **\*\* Oct. 13, 2009**

(54) **FRAME FOR A CHAIR BACK**

(75) Inventor: **Julien Egger**, Santa Monica, CA (US)

(73) Assignee: **True Seating Concepts, LLC** (MU)

(\*\*) Term: **14 Years**

(21) Appl. No.: **29/312,545**

(22) Filed: **Oct. 30, 2008**

(51) **LOC (9) Cl.** ..... **06-01**

(52) **U.S. Cl.** ..... **D6/502; D6/366**

(58) **Field of Classification Search** ..... D6/334-336,  
D6/364, 365, 366, 367, 369, 376, 379, 380,  
D6/499, 500-502; 297/284.4, 300.2, 411.27,  
297/411.36, 452.13, 452.18, 452.29, 452.3,  
297/452.46, 452.56, 452.64

See application file for complete search history.

(56) **References Cited**

**U.S. PATENT DOCUMENTS**

D510,671 S *	10/2005	Wu	.....	D6/502
D512,574 S *	12/2005	Tsai	.....	D6/366
D536,557 S *	2/2007	Lee	.....	D6/502
D548,994 S *	8/2007	Mao et al.	.....	D6/366
D549,473 S *	8/2007	Wagner	.....	D6/366

D549,474 S \* 8/2007 Wagner ..... D6/366

D568,624 S \* 5/2008 Wen ..... D6/366

D573,817 S \* 7/2008 Su ..... D6/502

D574,645 S \* 8/2008 Christensen ..... D6/502

D580,198 S \* 11/2008 Wu ..... D6/502

D580,199 S \* 11/2008 Su ..... D6/502

D585,205 S \* 1/2009 Wen ..... D6/366

\* cited by examiner

*Primary Examiner*—Mimosa De

(74) *Attorney, Agent, or Firm*—Morland C. Fischer

(57) **CLAIM**

The ornamental design for a frame for a chair back, as shown and described.

**DESCRIPTION**

FIG. 1 is a front elevational view of a frame for a chair back which forms my new design;

FIG. 2 is a rear elevational view thereof;

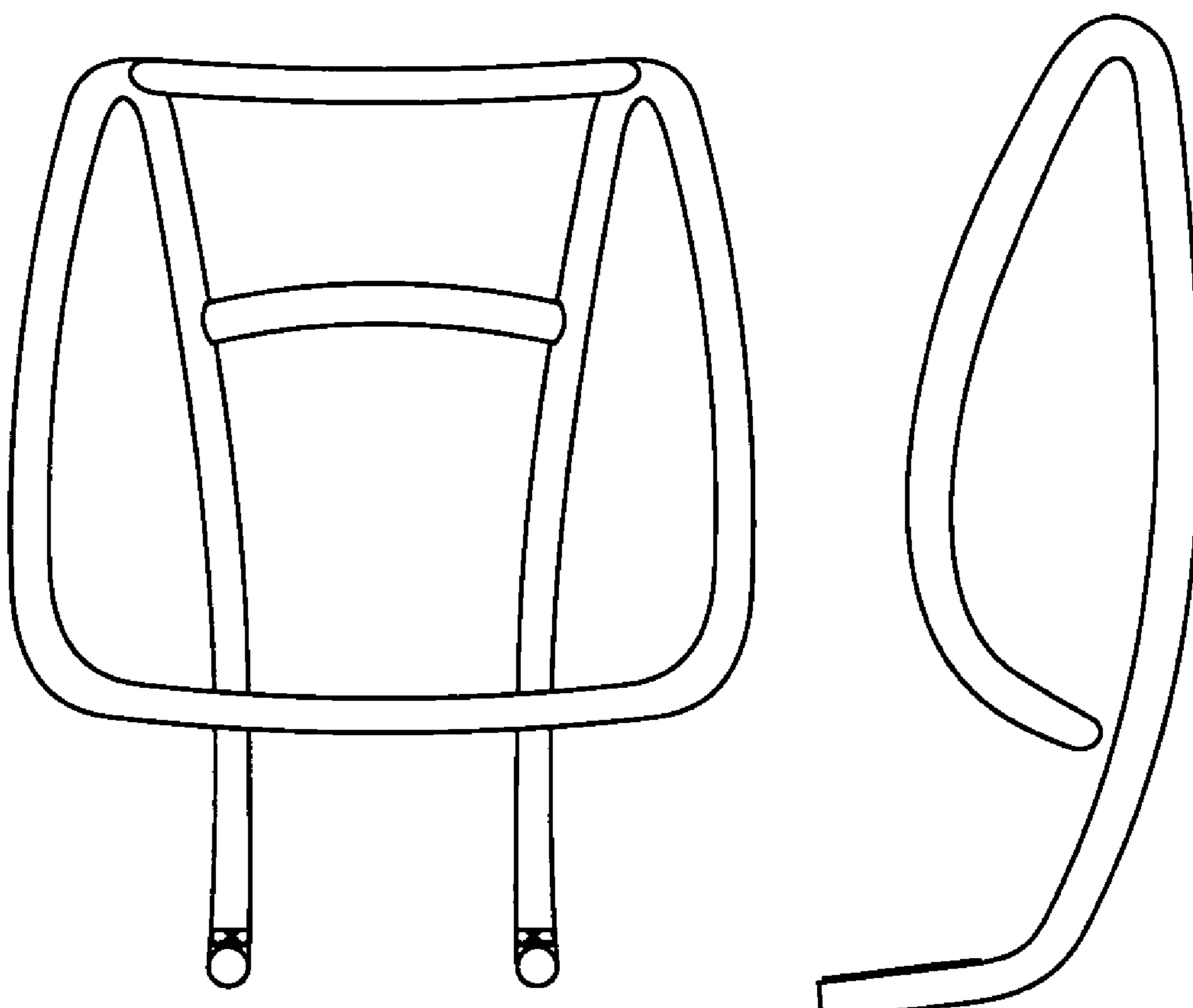
FIG. 3 is a right side elevational view thereof;

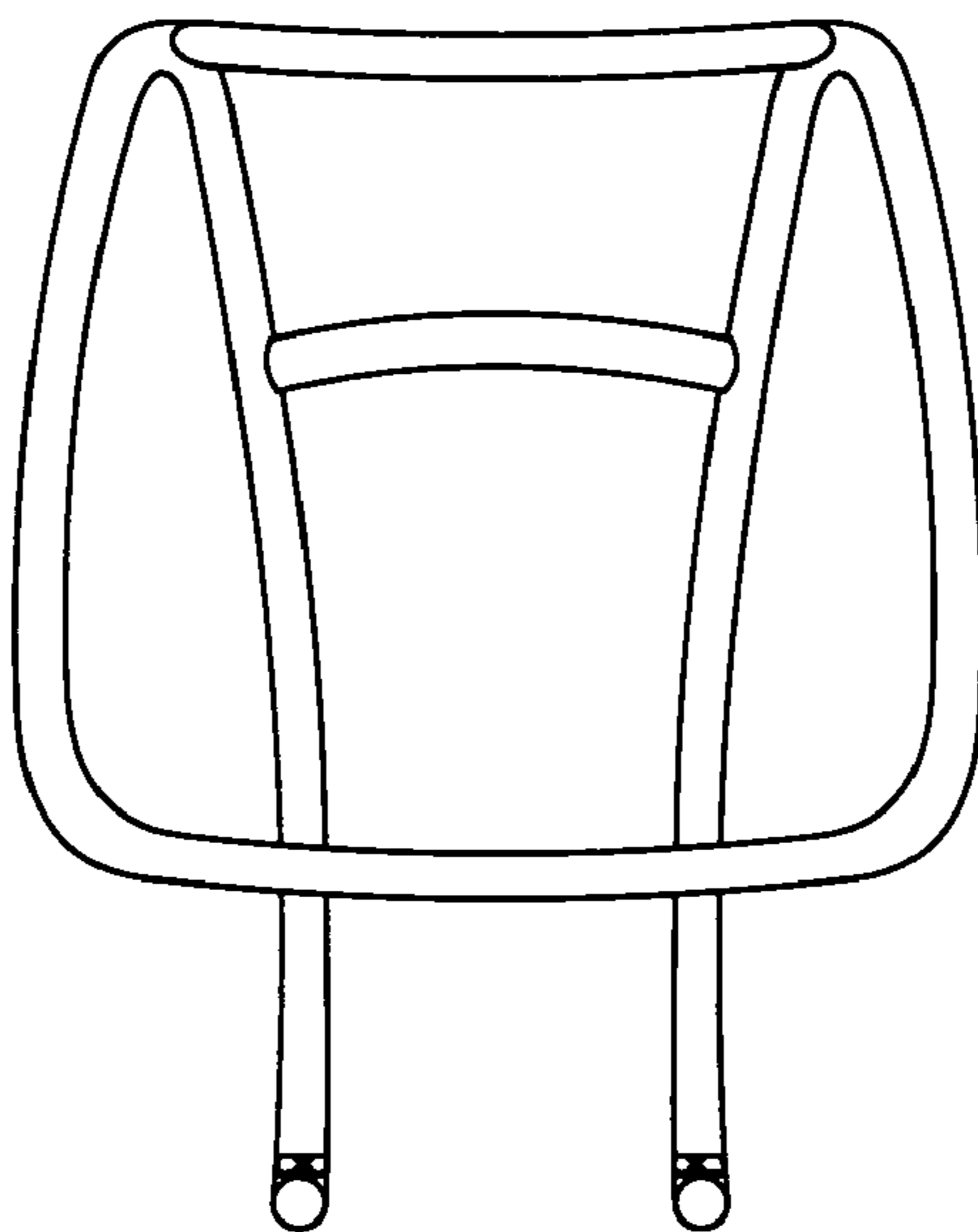
FIG. 4 is a left side elevational view thereof; and

FIG. 5 is a top plan view thereof; and,

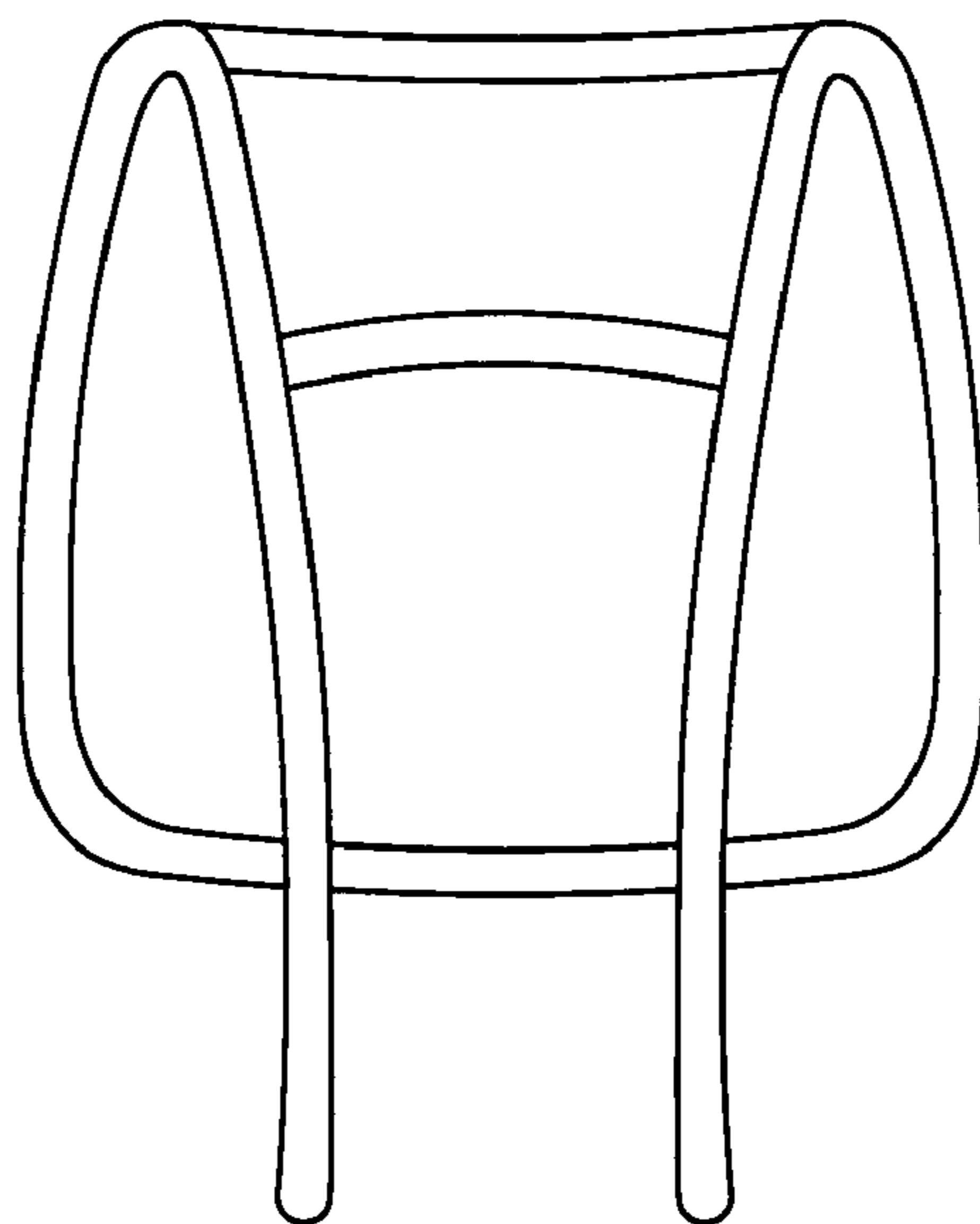
FIG. 6 is a bottom plan view thereof.

**1 Claim, 3 Drawing Sheets**

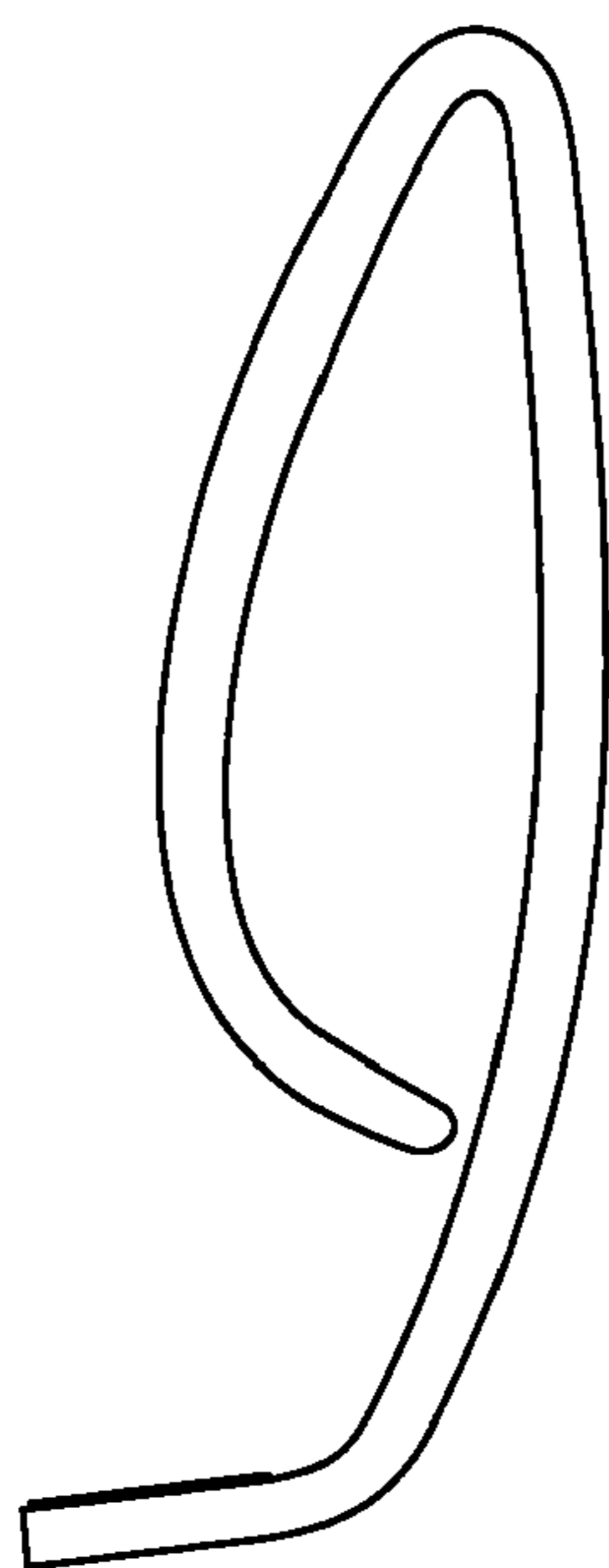




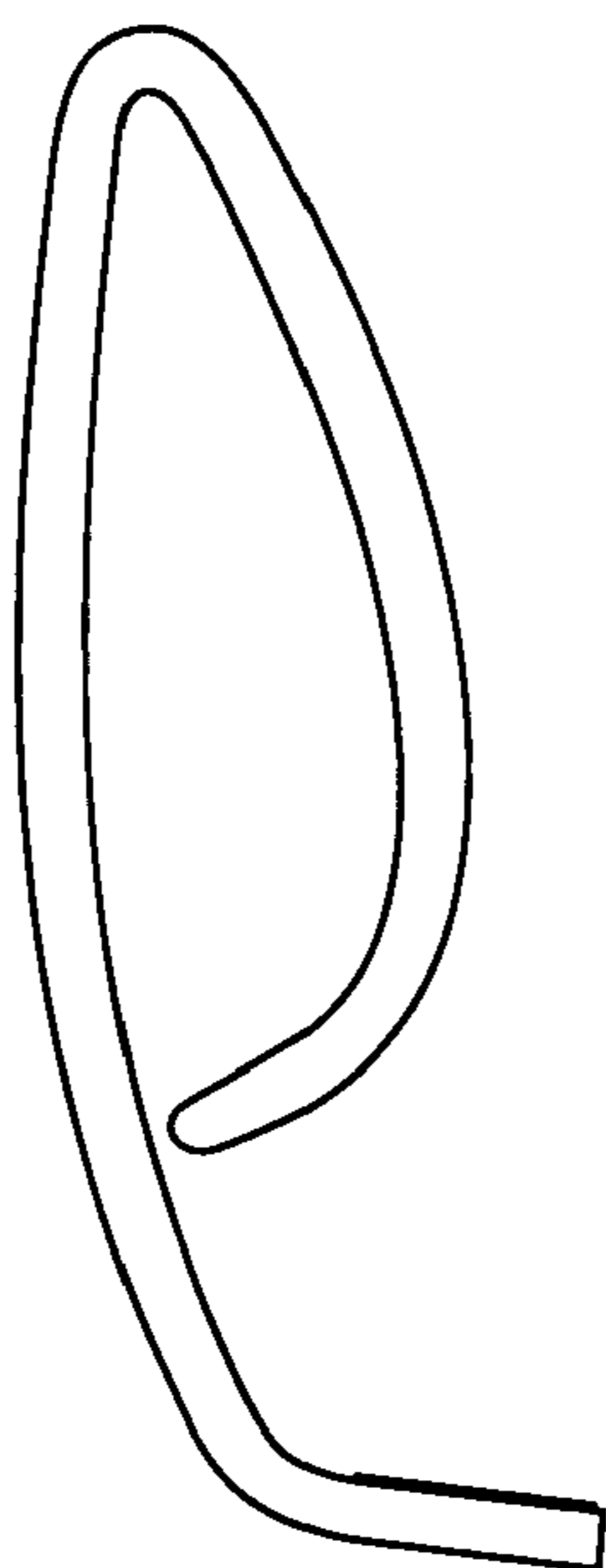
**FIG. 1**



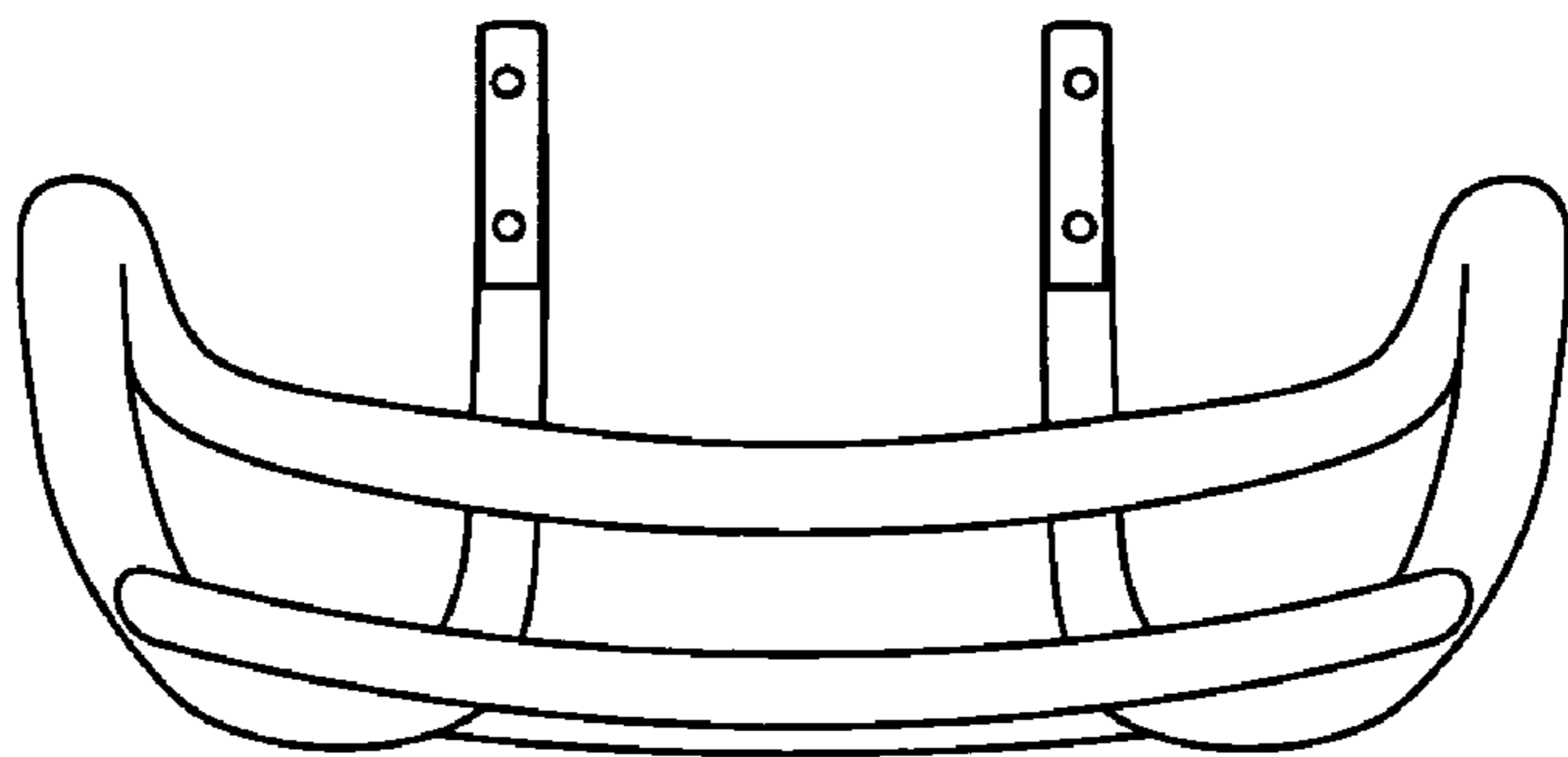
**FIG. 2**



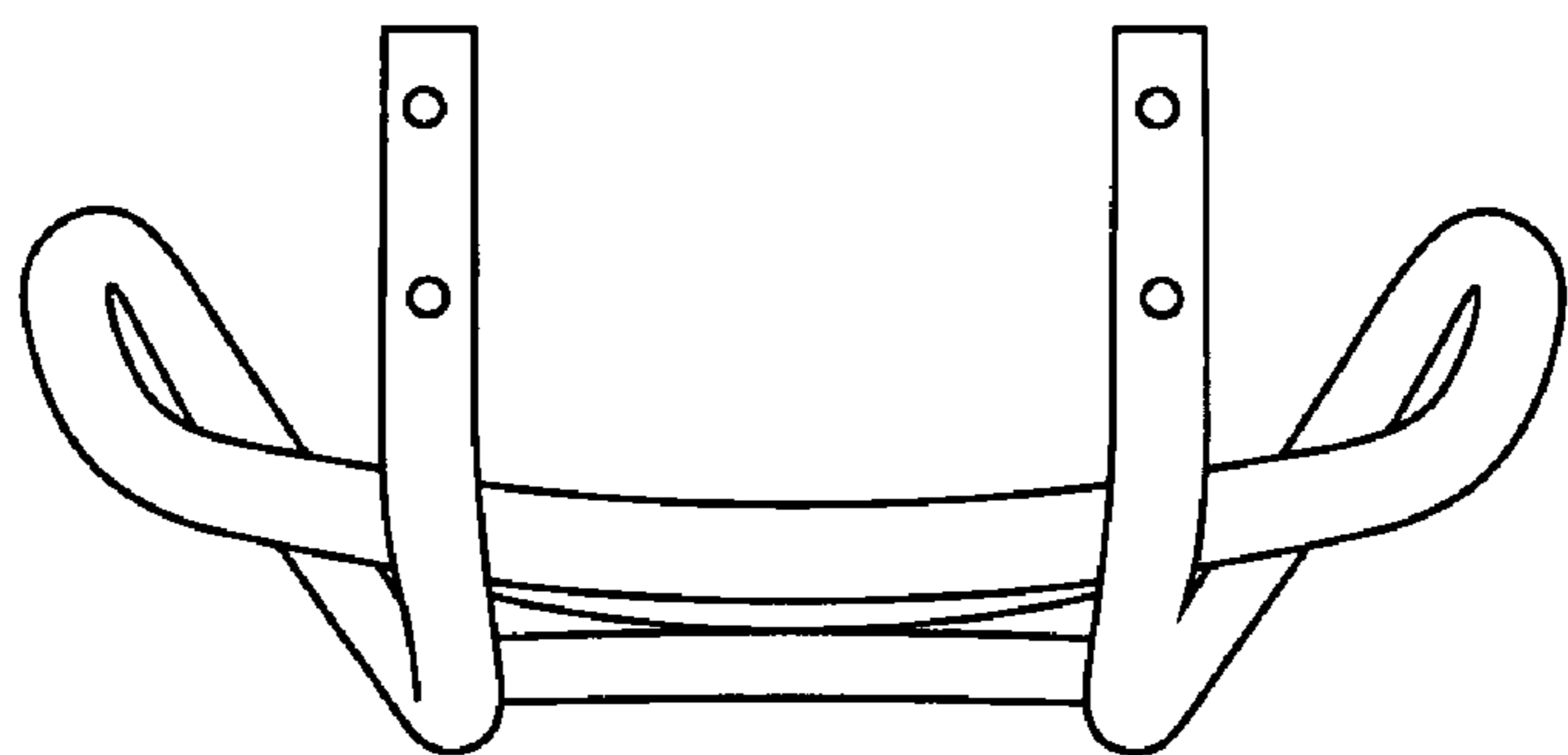
**FIG. 3**



**FIG. 4**



**FIG. 5**



**FIG. 6**