

US00D601825S

(12) **United States Design Patent**
Starck

(10) **Patent No.:** **US D601,825 S**
(45) **Date of Patent:** **** Oct. 13, 2009**

(54) **FURNITURE**

(75) Inventor: **Philippe Starck**, Paris (FR)

(73) Assignee: **Cassina S.p.A.**, Meda (Milan) (IT)

(**) Term: **14 Years**

(21) Appl. No.: **29/311,488**

(22) Filed: **Mar. 31, 2009**

(30) **Foreign Application Priority Data**

Jan. 13, 2009 (WO) DM/071352

(51) **LOC (9) Cl.** **06-01**

(52) **U.S. Cl.** **D6/381**

(58) **Field of Classification Search** D6/334,
D6/349, 355, 364, 370, 374, 378, 381, 382,
D6/383, 491, 495, 500-503; 294/68, 232,
294/233, 353, 445.1, 448.1, 448.2, DIG. 7;
5/12.1, 12.2

See application file for complete search history.

(56) **References Cited**

U.S. PATENT DOCUMENTS

D257,454 S *	10/1980	Nash	D6/364
D388,630 S *	1/1998	Lowman et al.	D6/381
D423,808 S *	5/2000	Natuzzi et al.	D6/381
D427,448 S *	7/2000	Natuzzi et al.	D6/381
D439,071 S *	3/2001	D'Urso et al.	D6/381
D564,774 S *	3/2008	Woods et al.	D6/381
D583,585 S *	12/2008	Weiss	D6/381
D584,524 S *	1/2009	Ricci	D6/381

* cited by examiner

Primary Examiner—Sandra Snapp

(74) *Attorney, Agent, or Firm*—Nixon & Vanderhye P.C.

(57) **CLAIM**

The ornamental design for furniture, as shown and described.

DESCRIPTION

FIG. 1 is a front elevational view of a first embodiment of furniture shown in the form of a sofa with the pillows located in a first position;

FIG. 2 is a rear elevational view thereof;

FIG. 3 is a right elevational view thereof;

FIG. 4 is a left elevational view thereof;

FIG. 5 is a top plan view thereof;

FIG. 6 is a bottom plan view thereof;

FIG. 7 is a front, left perspective view thereof;

FIG. 8 is a front elevational view of a second embodiment of furniture shown in the form of a chair;

FIG. 9 is a rear elevational view thereof;

FIG. 10 is a right elevational view thereof;

FIG. 11 is a left elevational view thereof;

FIG. 12 is a top plan view thereof;

FIG. 13 is a bottom plan view thereof;

FIG. 14 is a front, left perspective view thereof;

FIG. 15 is a front elevational view of a first embodiment of furniture shown in the form of a sofa with the pillows located in a second position;

FIG. 16 is a rear elevational view thereof;

FIG. 17 is a right elevational view thereof;

FIG. 18 is a left elevational view thereof;

FIG. 19 is a top plan view thereof;

FIG. 20 is a bottom plan view thereof; and,

FIG. 21 is a front, left perspective view thereof.

The broken lines shown in the drawings are for illustrative purposes only and form no part of the claimed design.

1 Claim, 18 Drawing Sheets

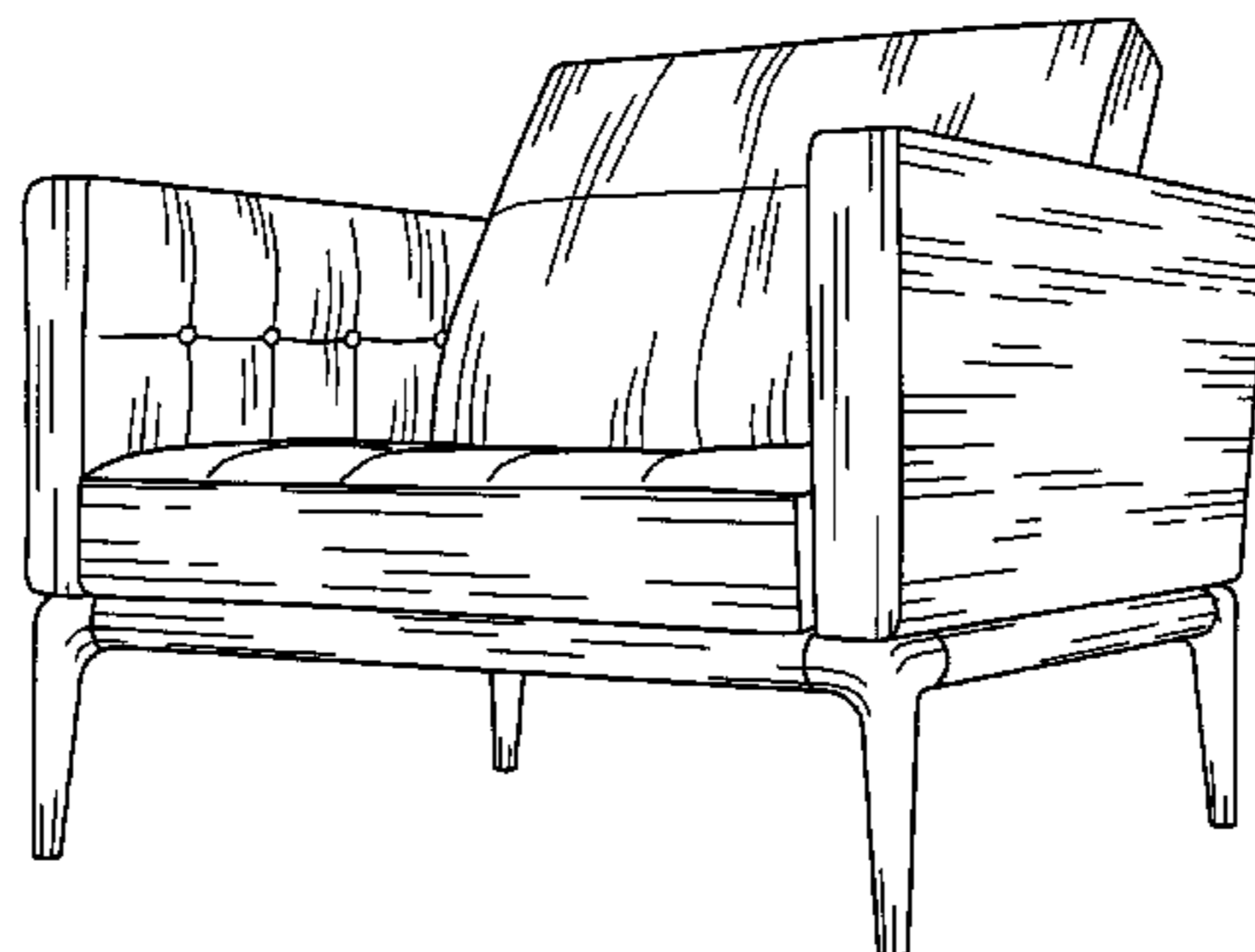
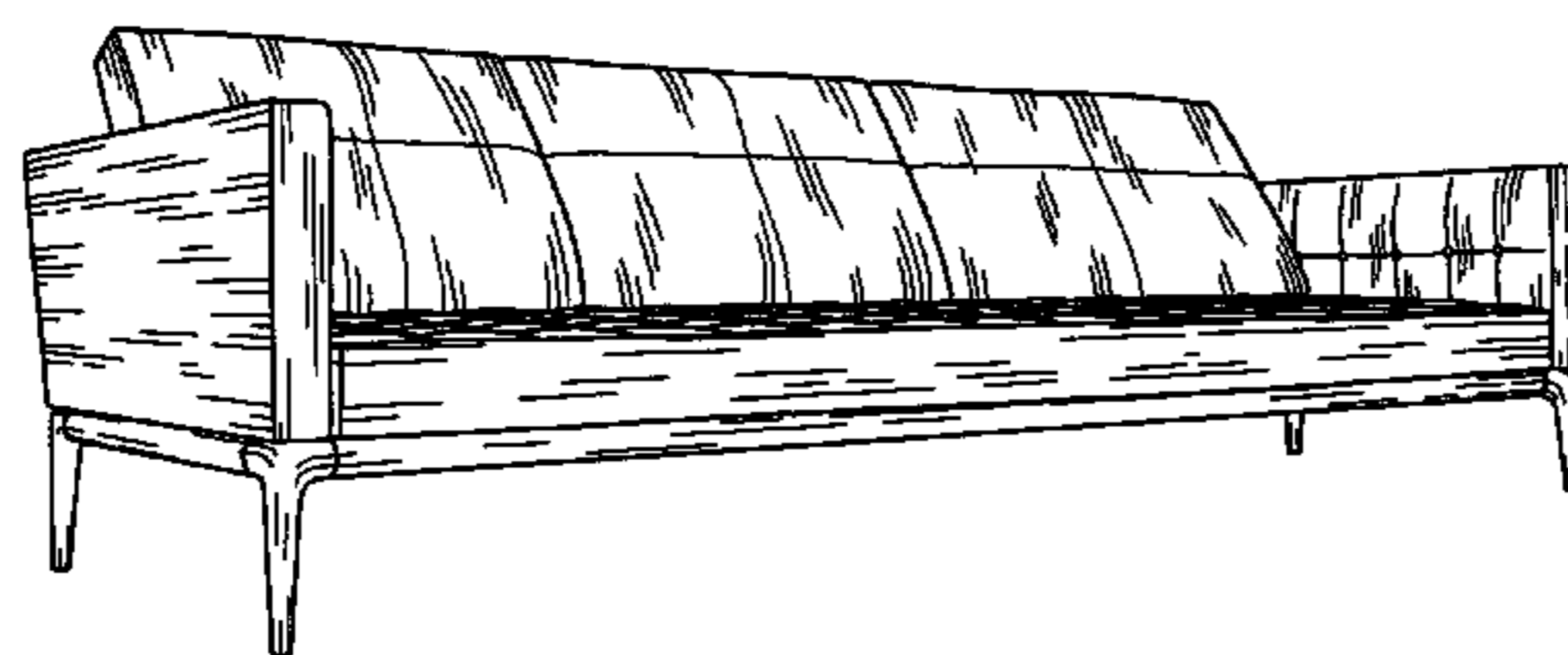

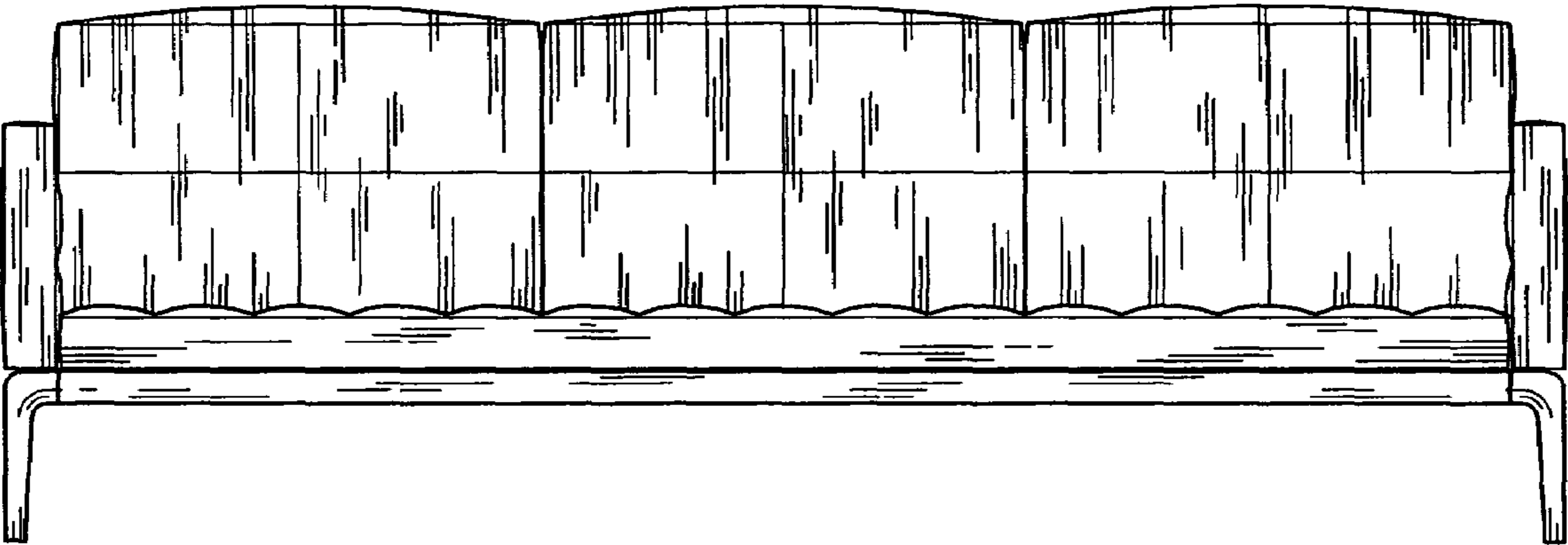

FIG. 1



FIG. 2

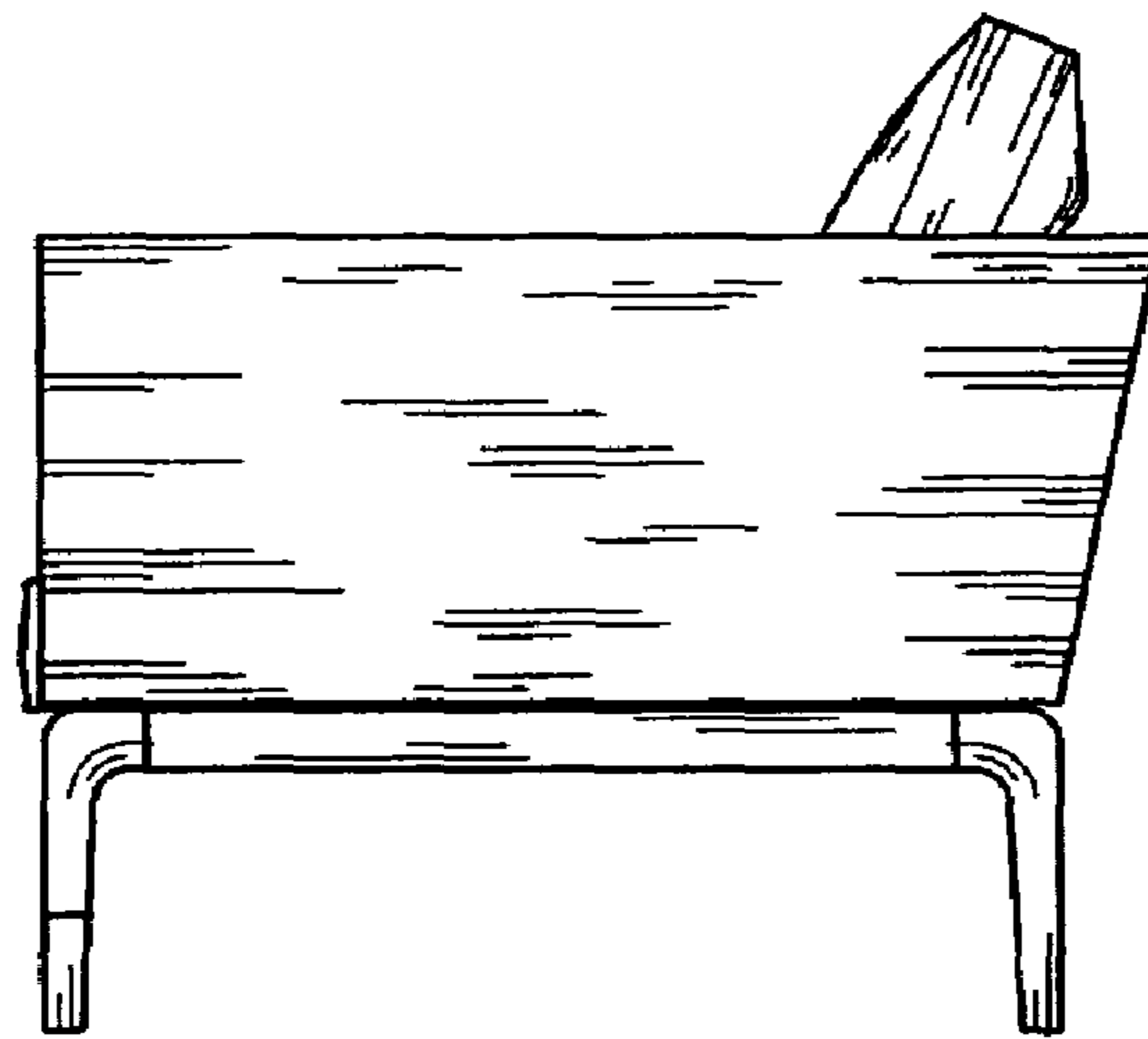

FIG. 3

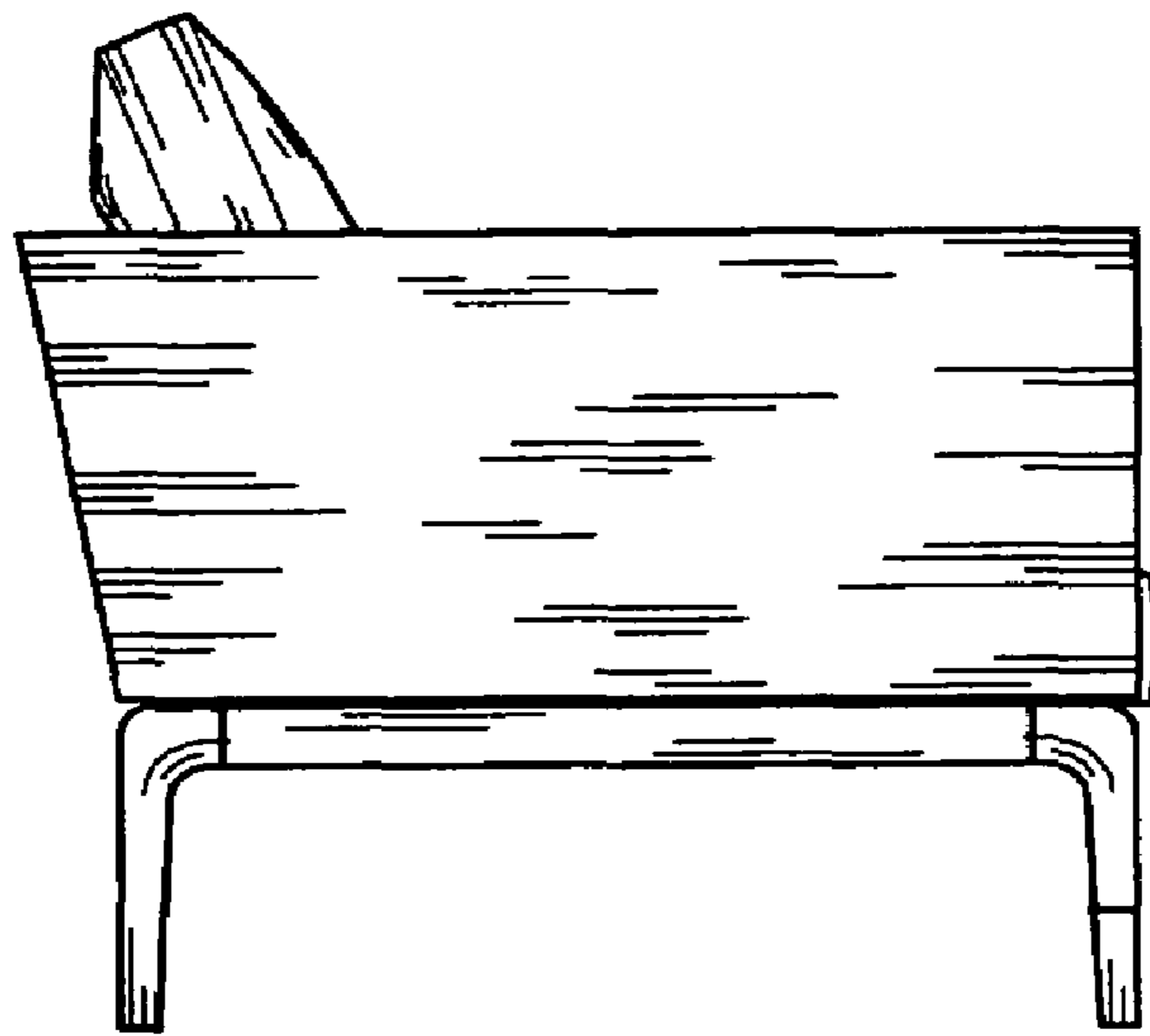

FIG. 4

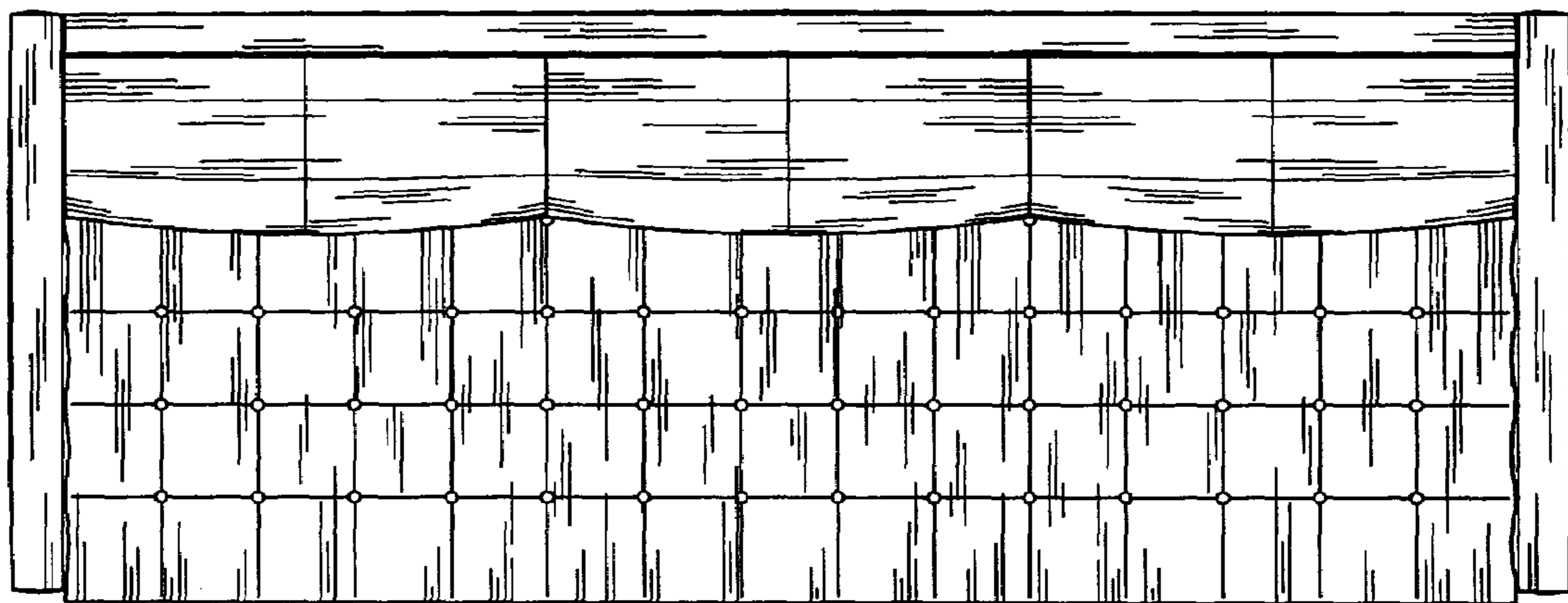

FIG. 5

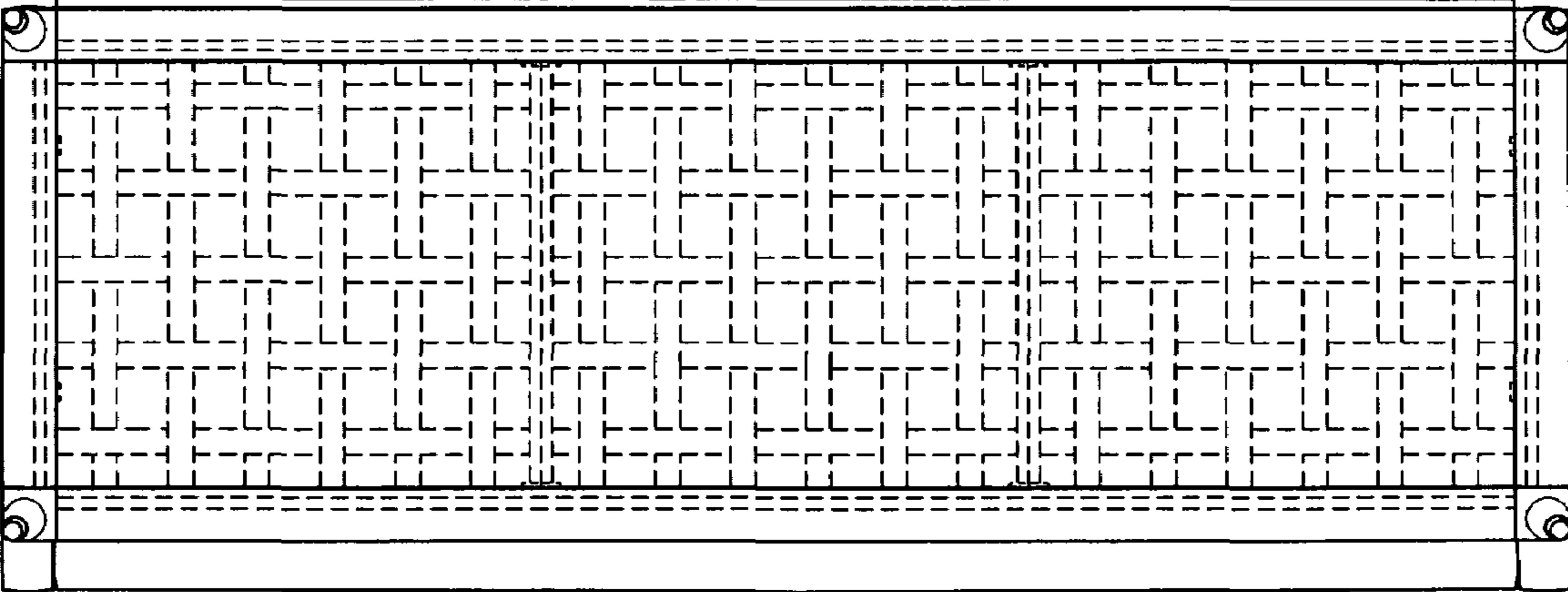

FIG. 6

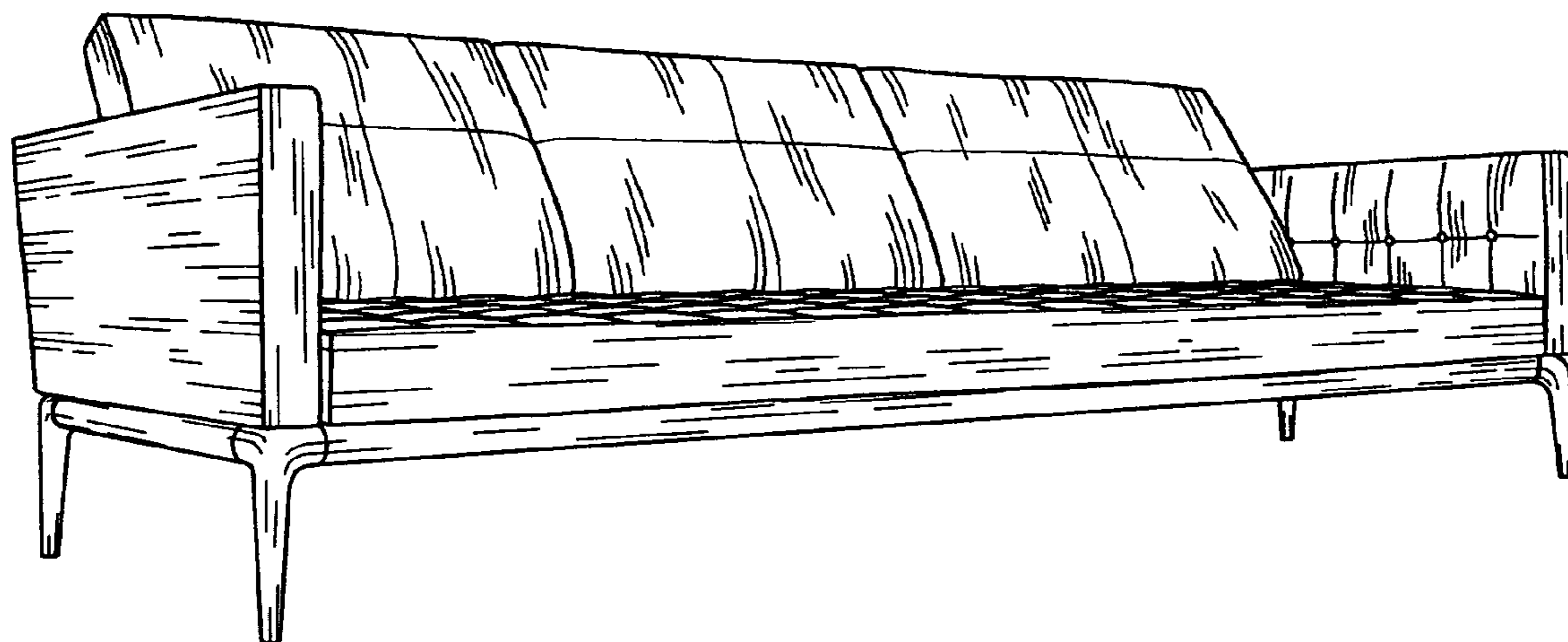

FIG. 7

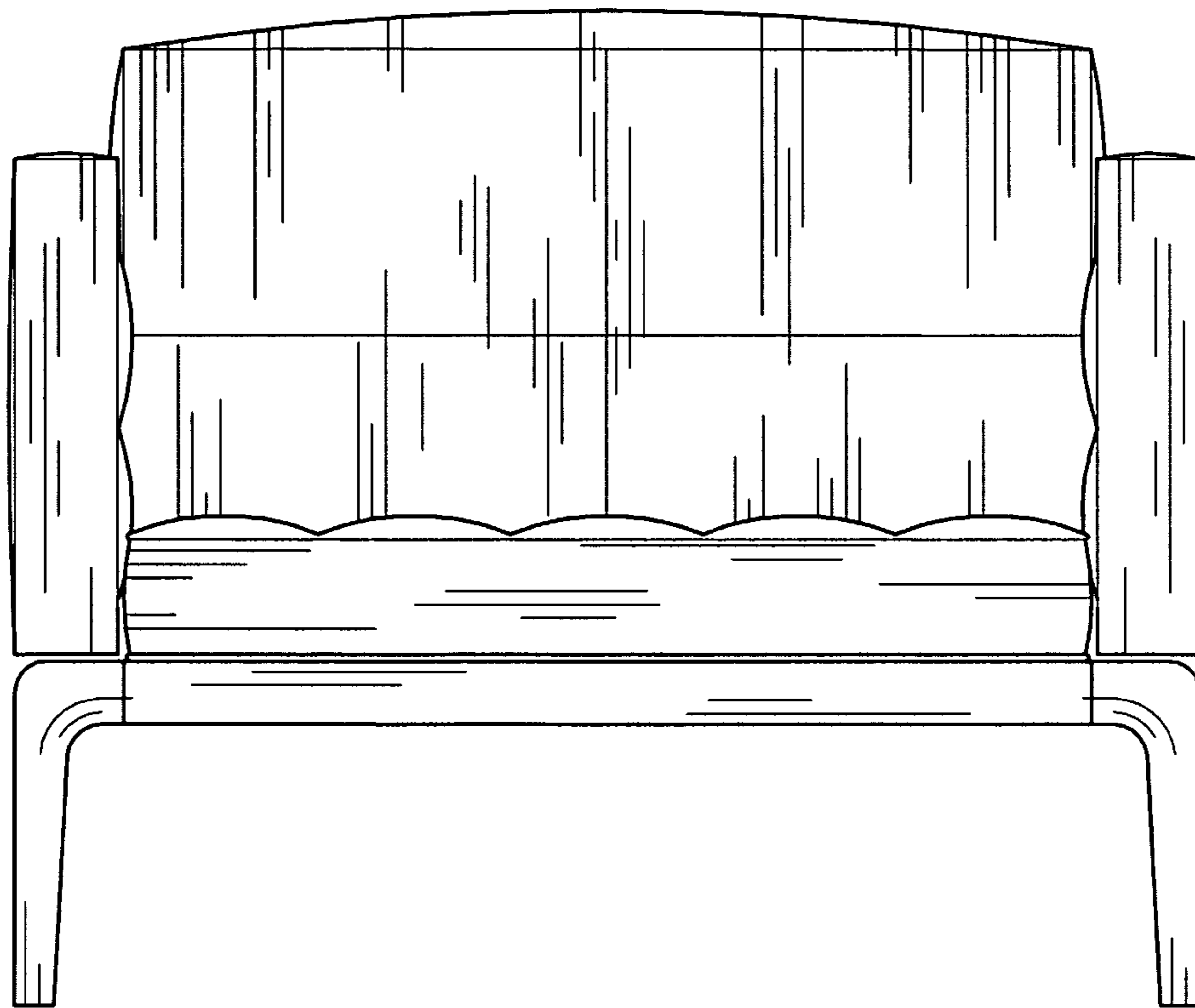

FIG. 8

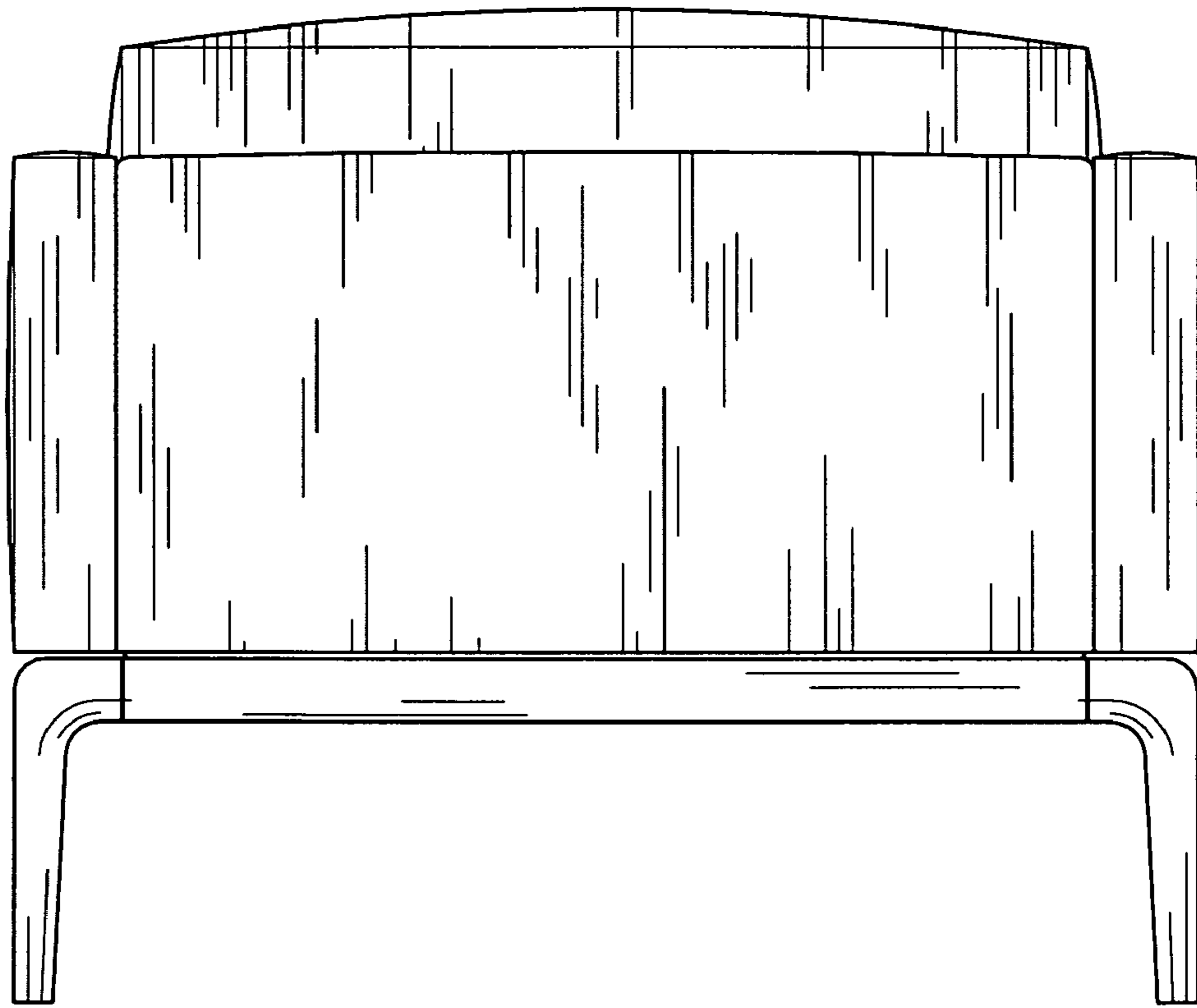

FIG. 9

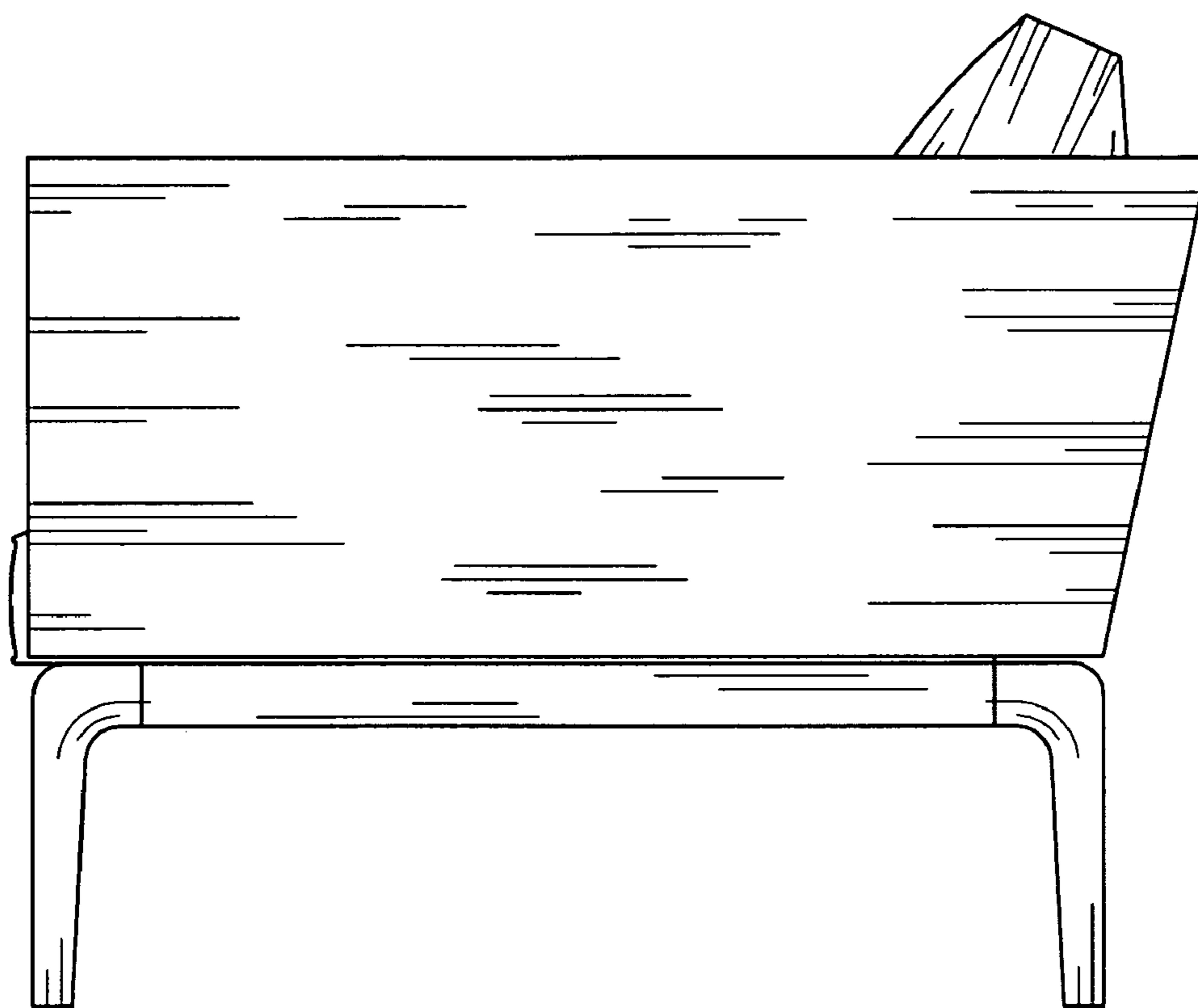

FIG. 10

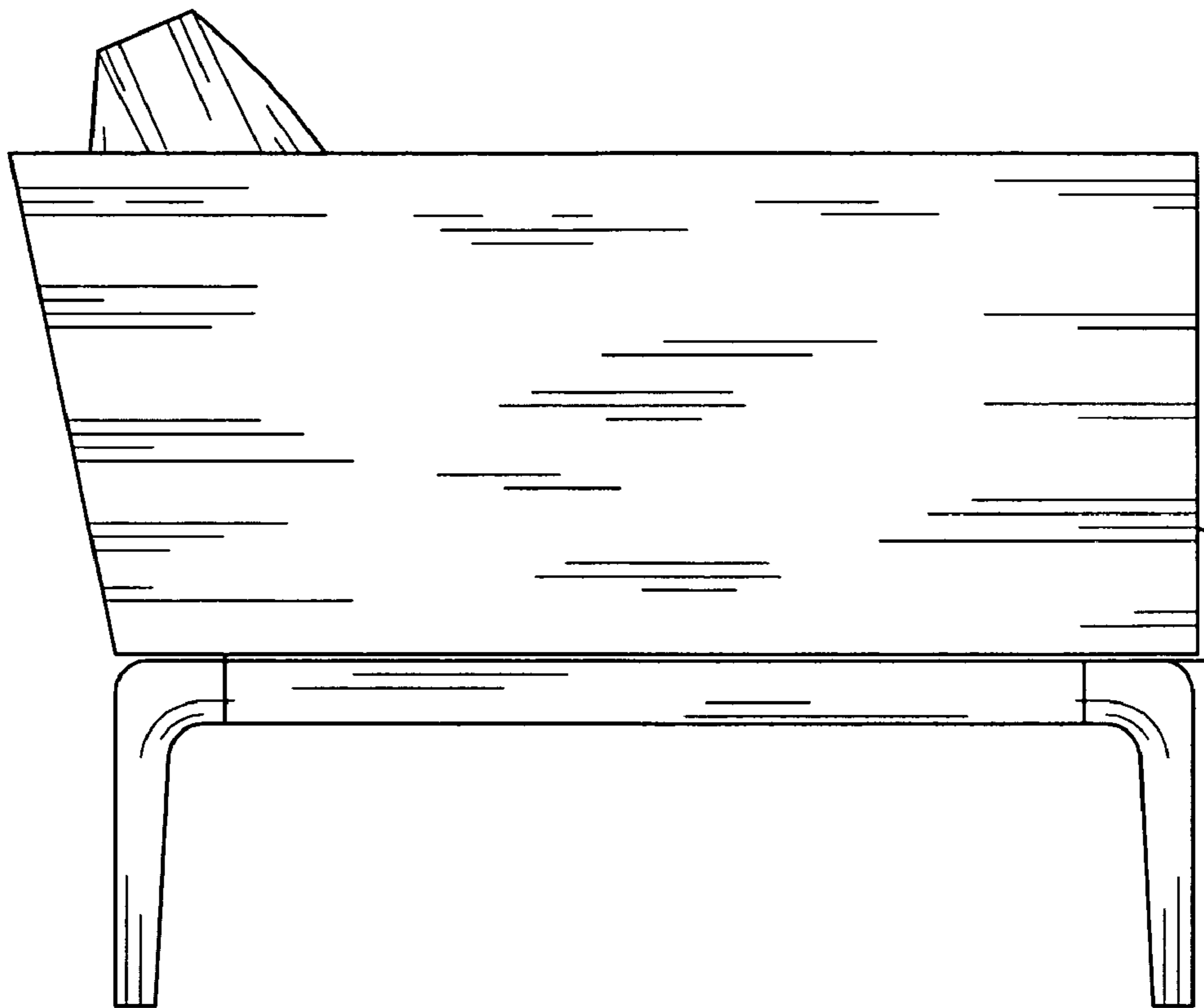

FIG. 11

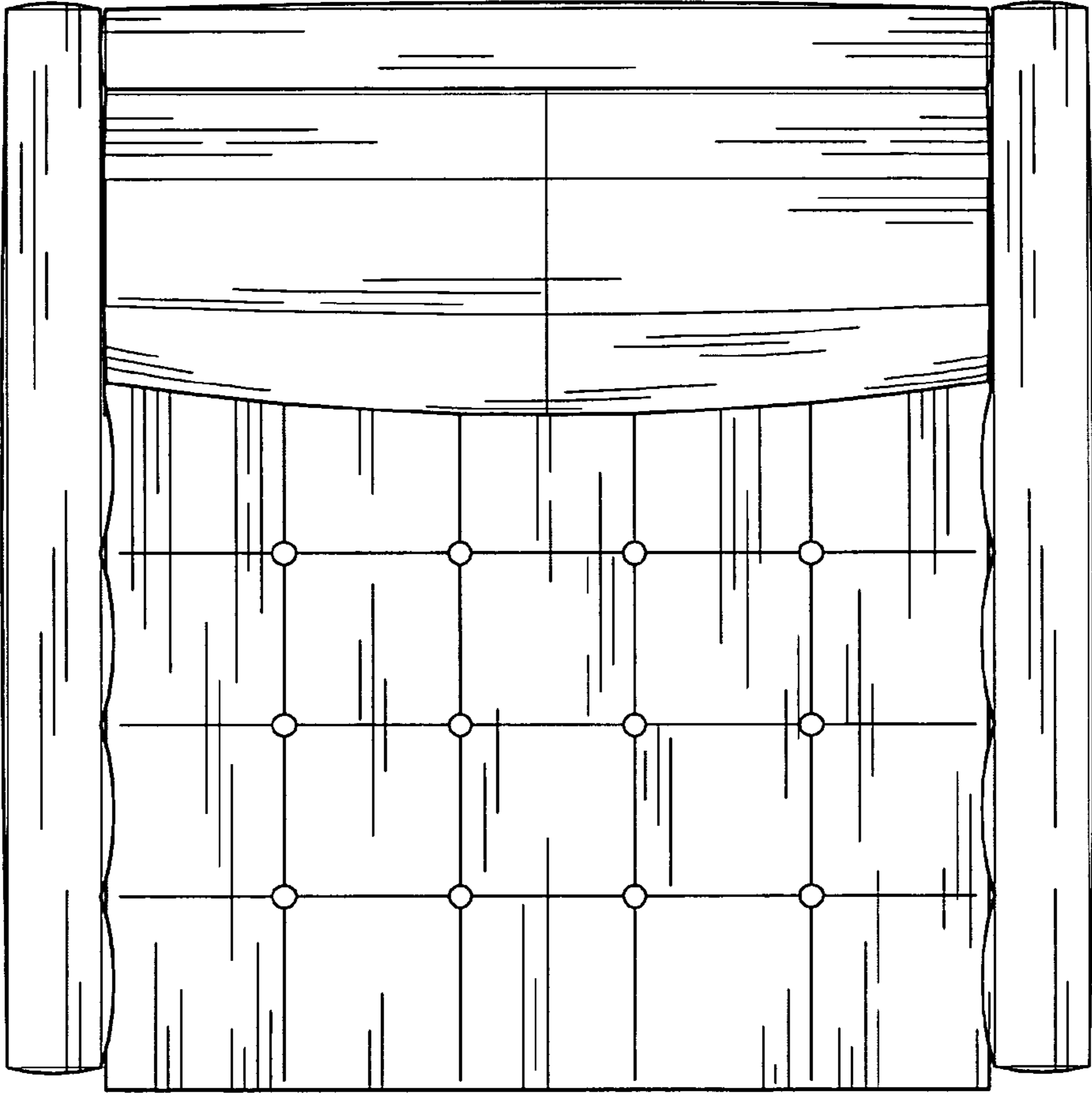

FIG. 12

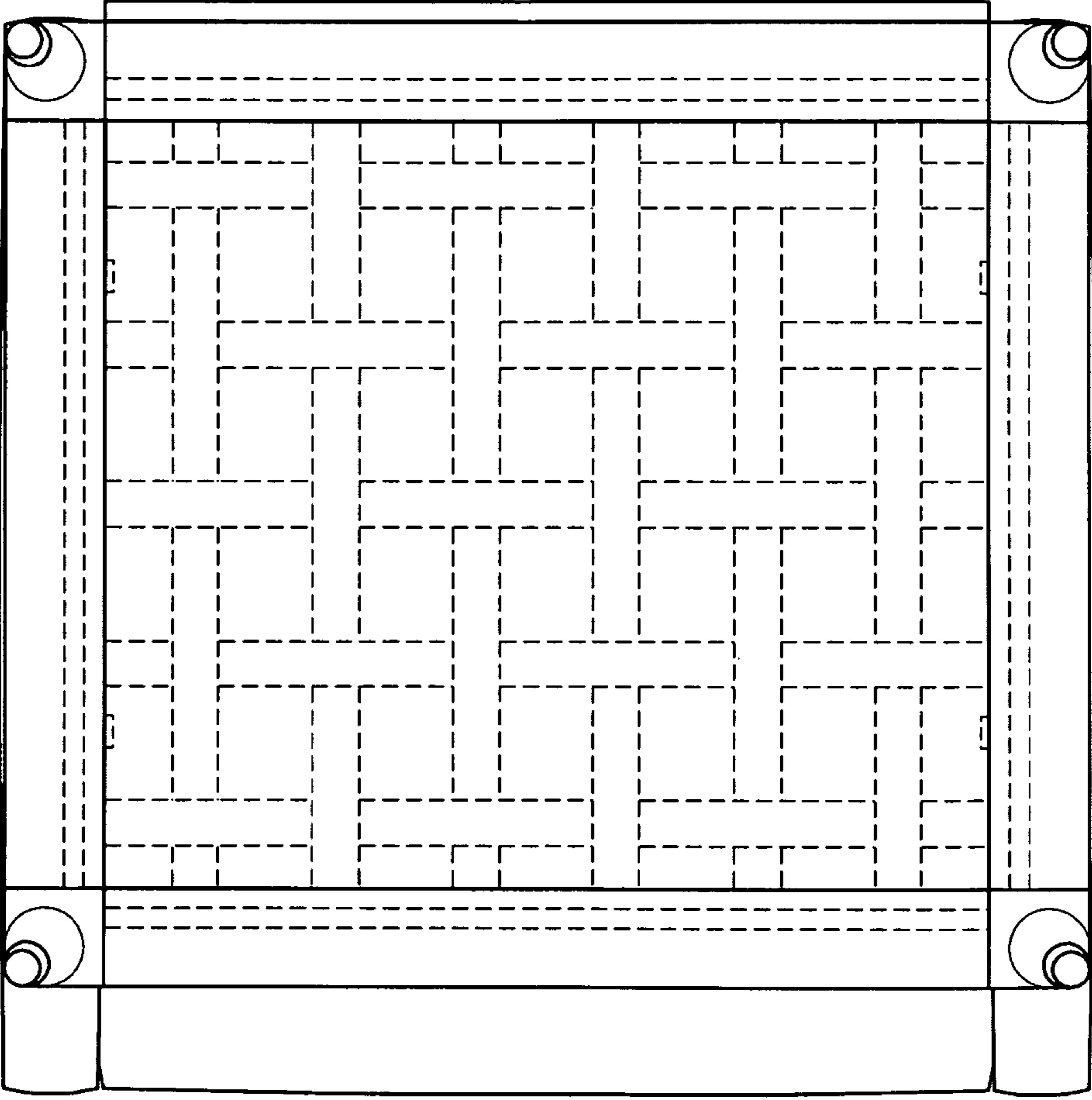

FIG. 13

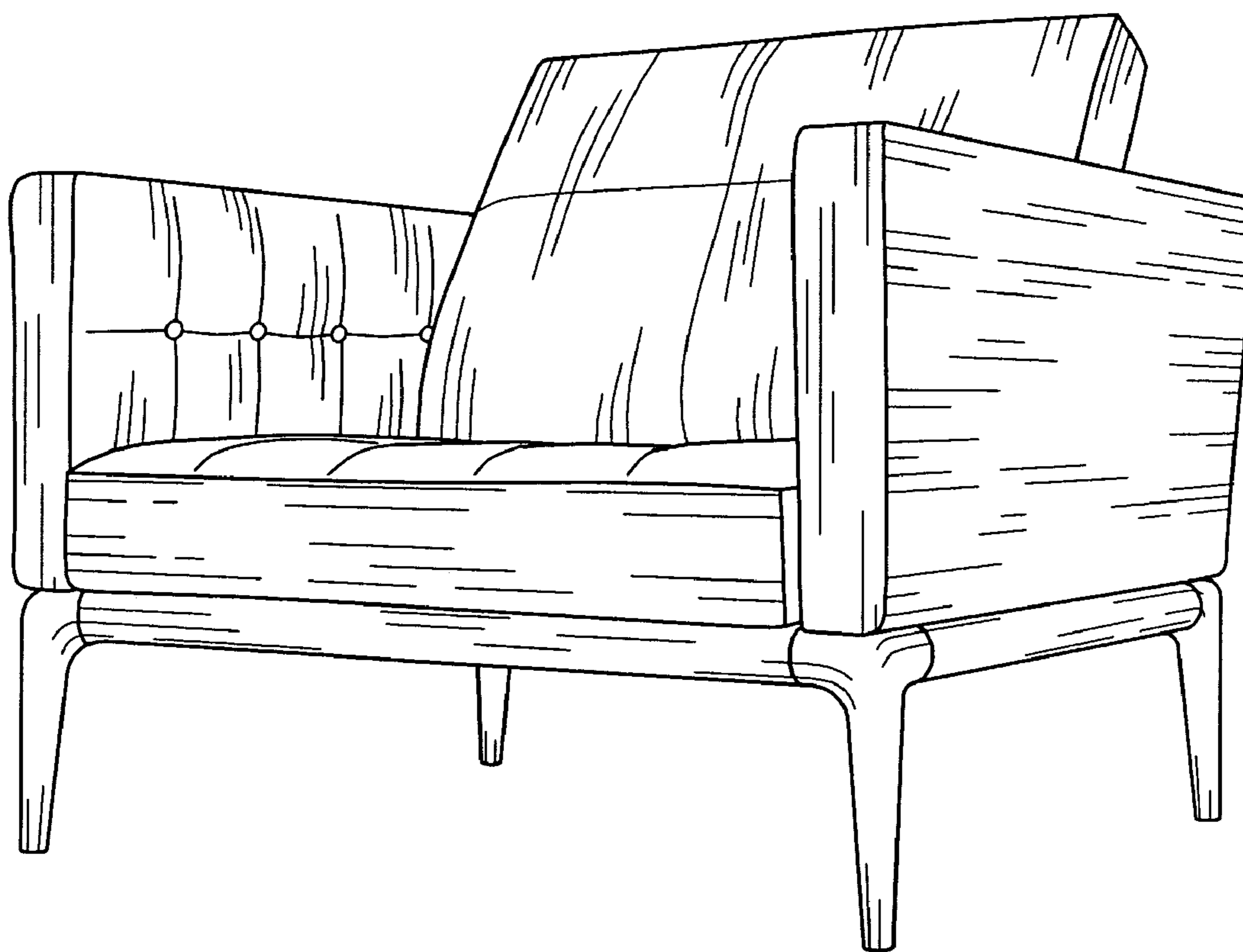

FIG. 14

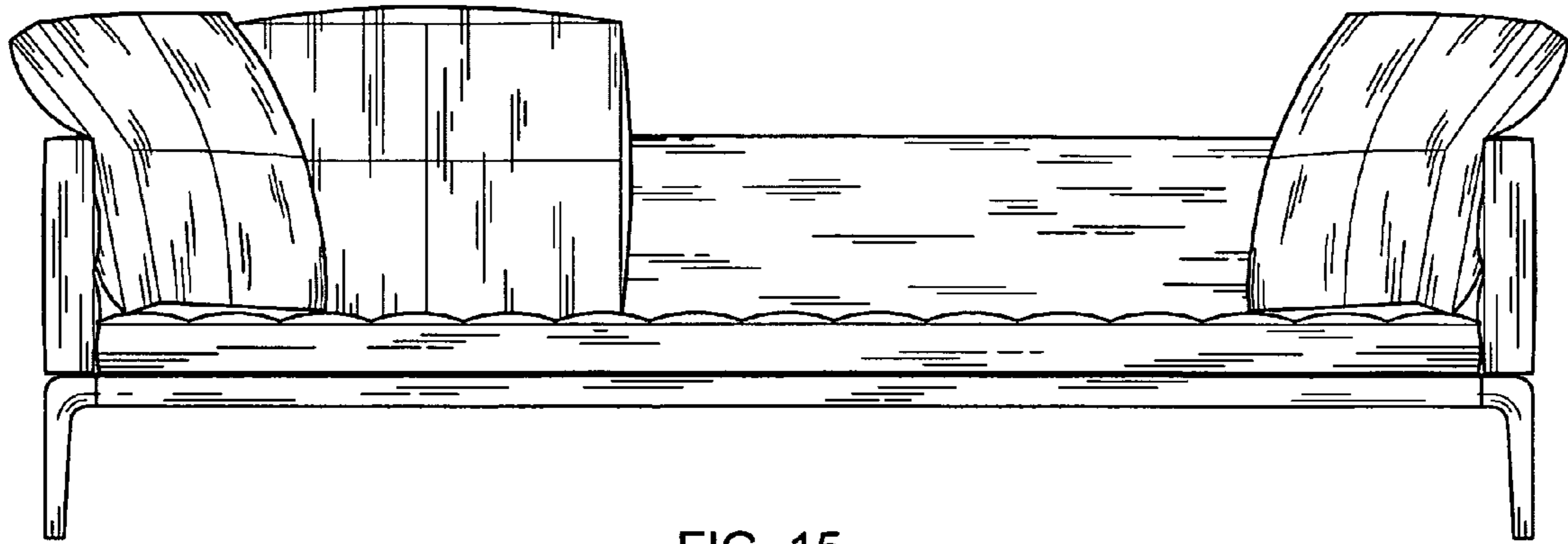

FIG. 15

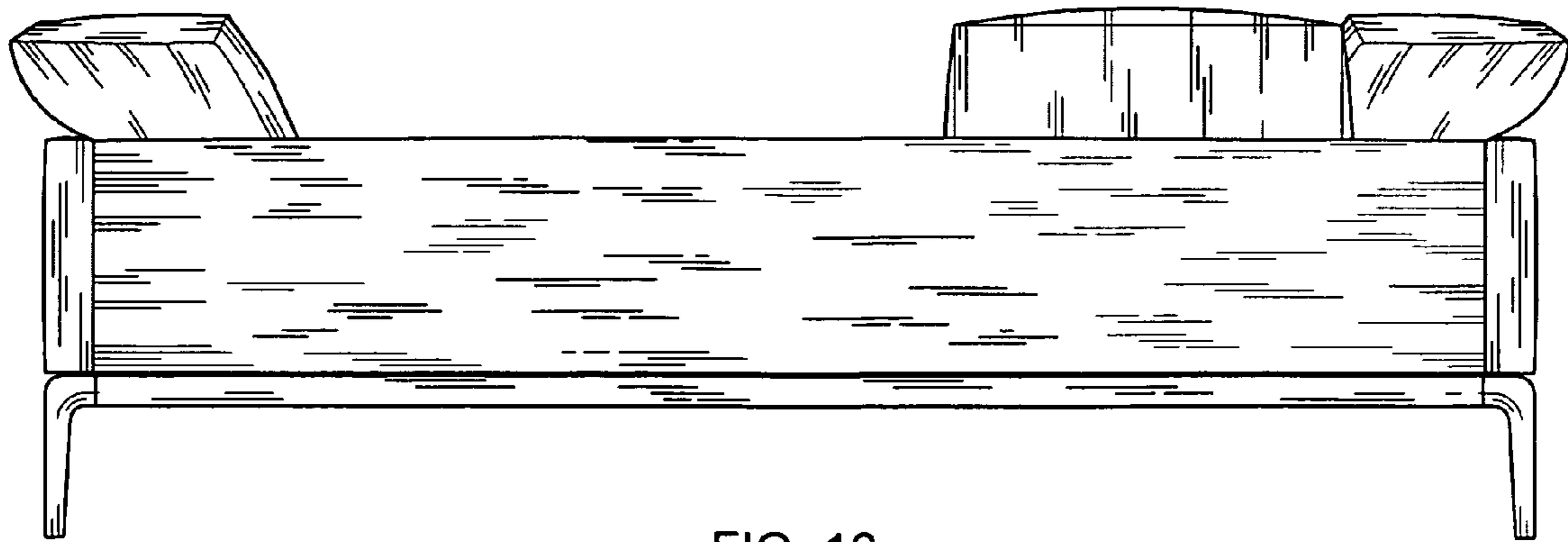

FIG. 16

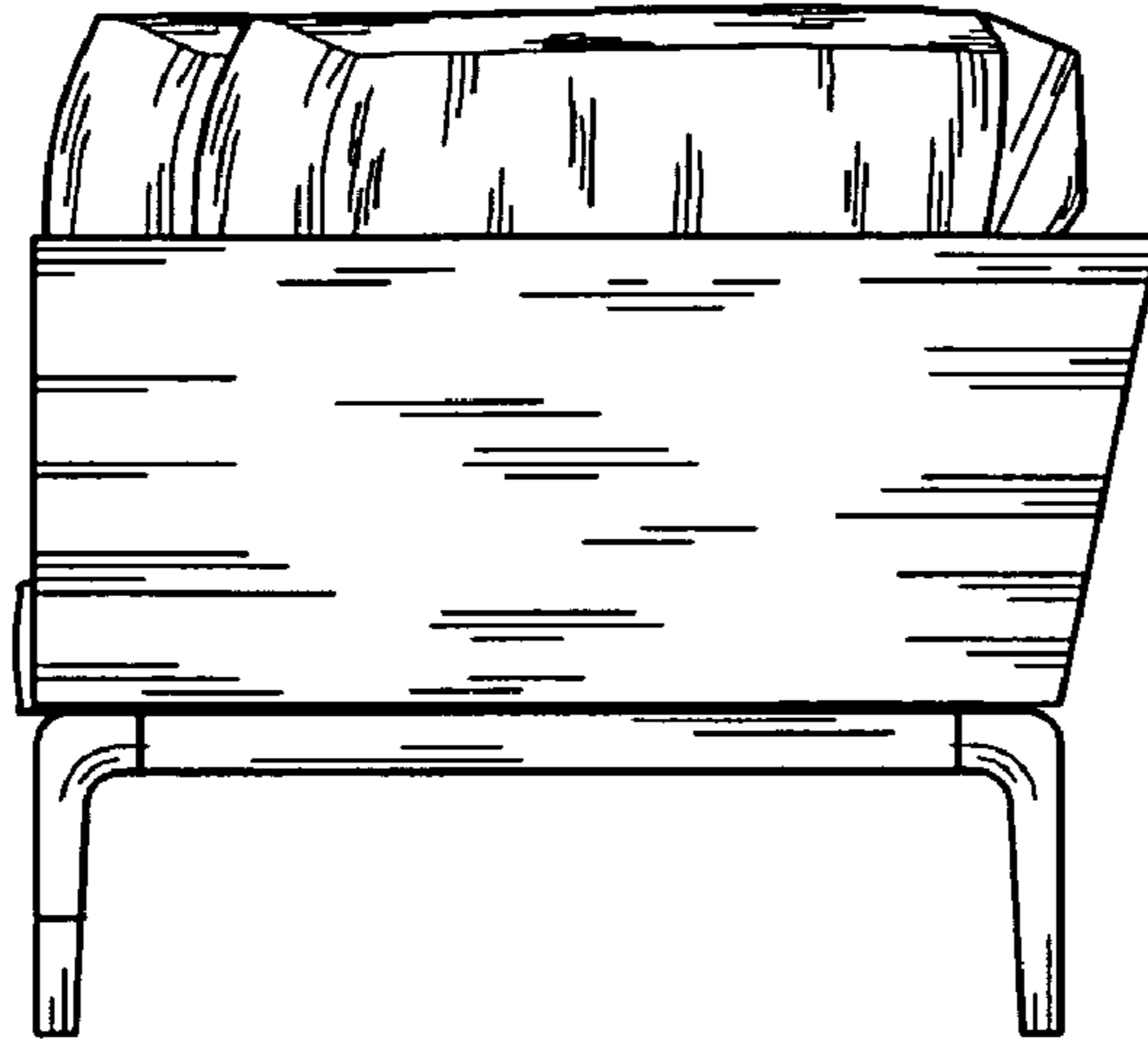

FIG. 17

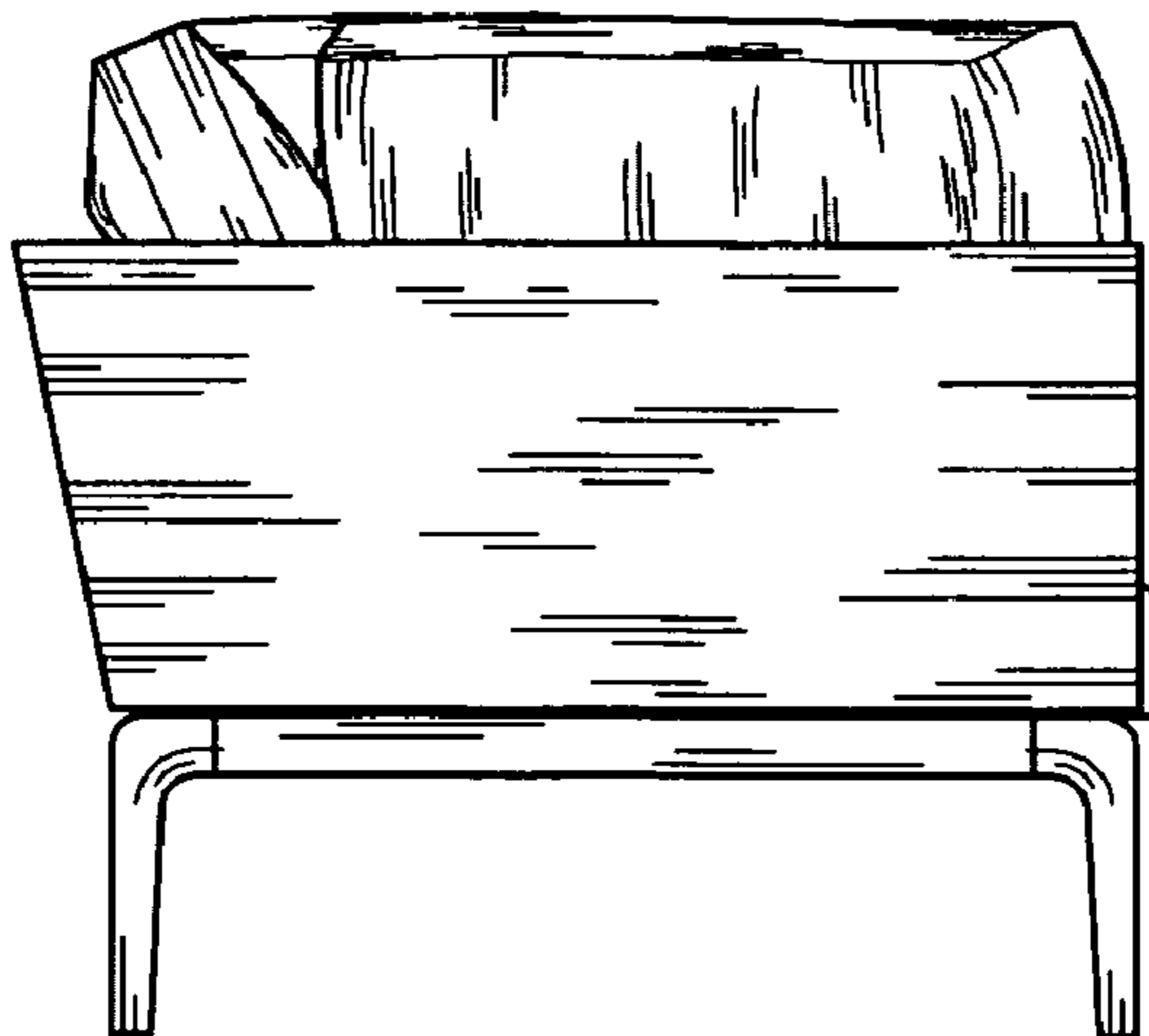

FIG. 18

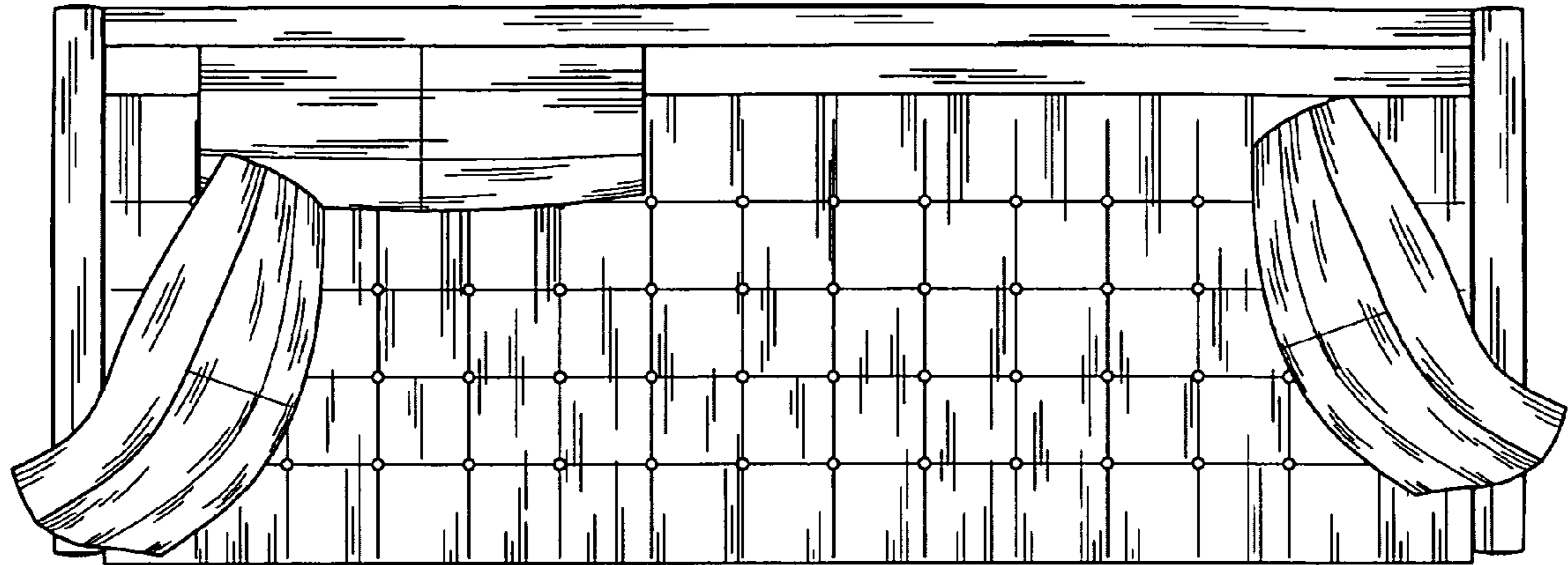

FIG. 19

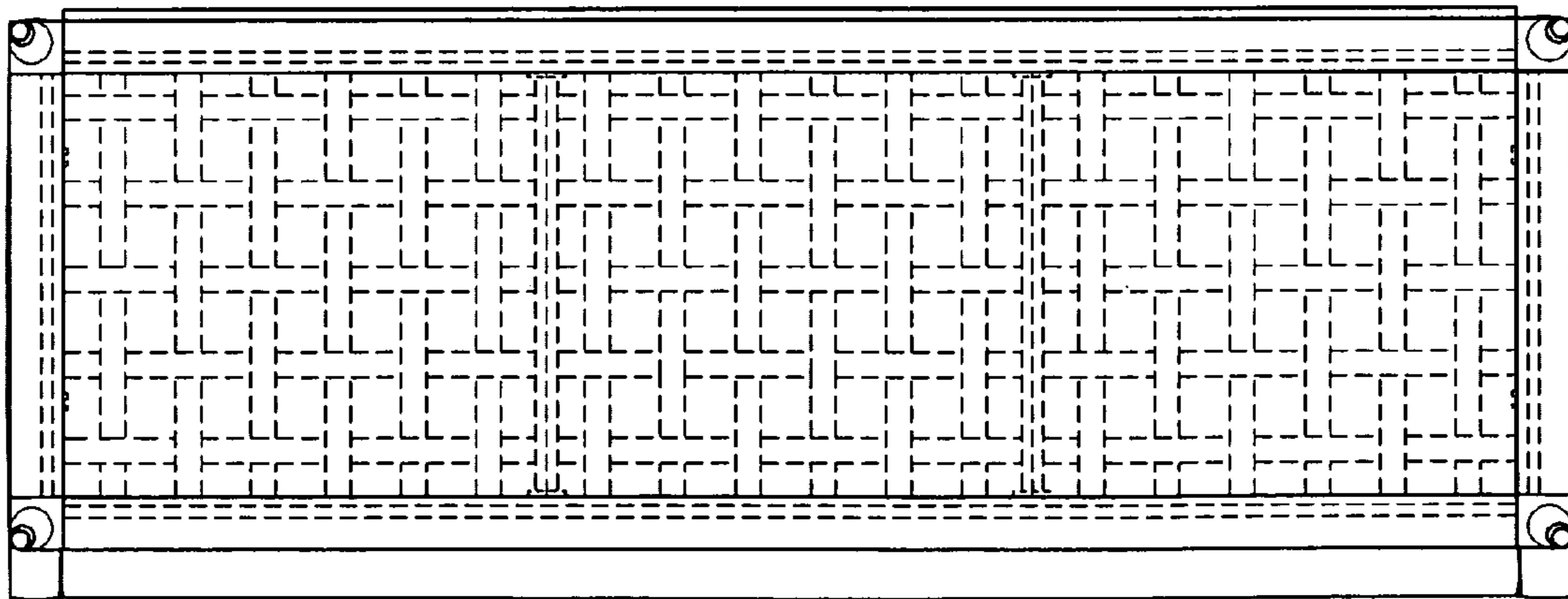

FIG. 20

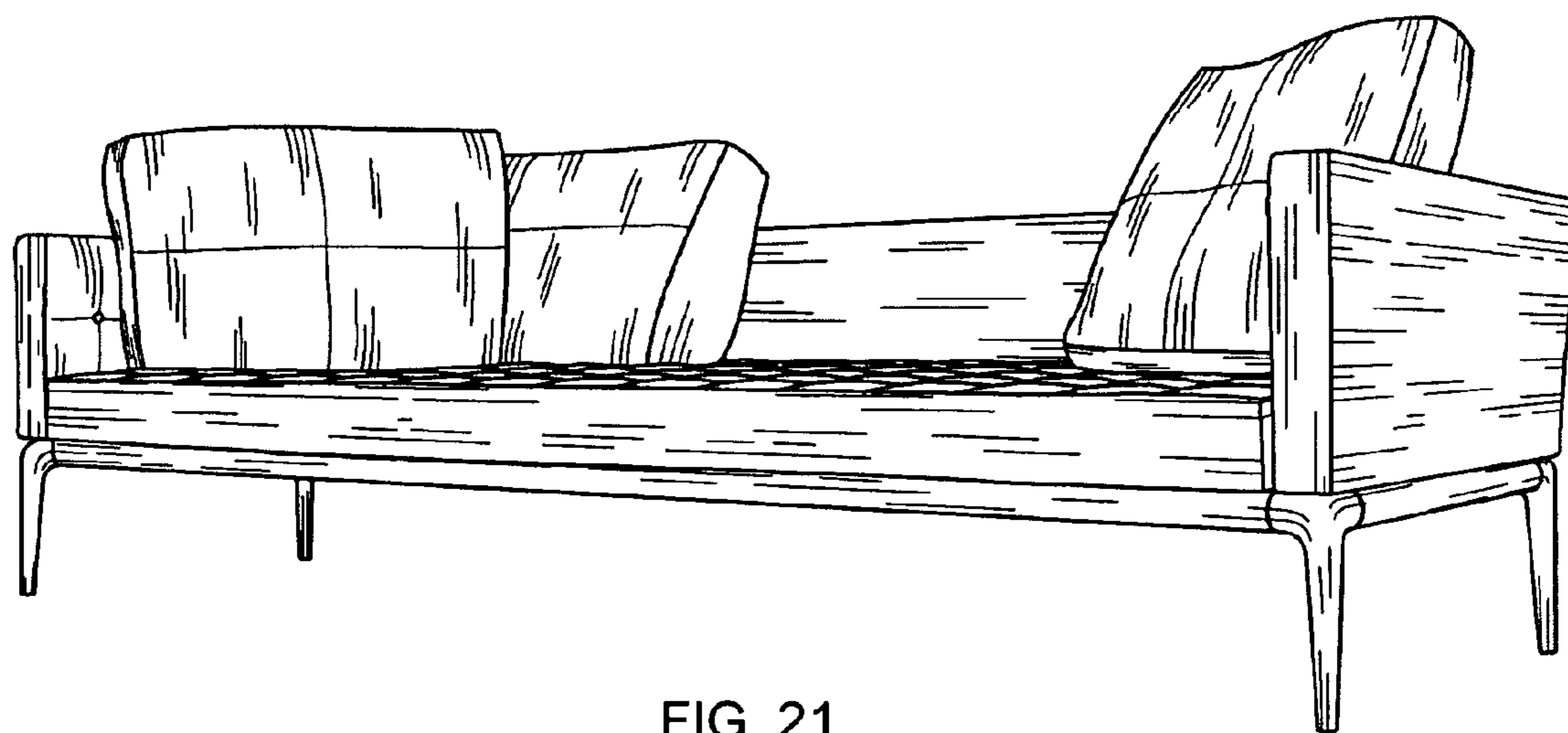

FIG. 21