



US00D601772S

(12) **United States Design Patent**  
**de Rueda et al.**

(10) **Patent No.:** **US D601,772 S**

(45) **Date of Patent:** **\*\* Oct. 6, 2009**

(54) **CART DEVICE**

(76) Inventors: **Tomas de Rueda**, Avenida Camaron-Sabalo #6300, Mazatlan, Sinaloa (MX) 82110; **Linda de Rueda**, Avenida Camaron-Sabalo #6300, Mazatlan, Sinaloa (MX) 82110; **Linda de Rueda-Cevallos**, Avenida Camaron-Sabalo #6300, Mazatlan, Sinaloa (MX)

(\*\*) Term: **14 Years**

(21) Appl. No.: **29/331,666**

(22) Filed: **Jan. 29, 2009**

(51) **LOC (9) Cl.** ..... **12-02**

(52) **U.S. Cl.** ..... **D34/12**

(58) **Field of Classification Search** ..... D34/12-27;  
280/651, 641, 652, 43.1, 47.26, 47.34, 47.35  
See application file for complete search history.

(56) **References Cited**

U.S. PATENT DOCUMENTS

D156,701 S *	1/1950	Concklink	.....	D34/22
D186,980 S *	1/1960	Molitor	.....	D34/17
3,118,553 A	1/1964	Rosenzweig		
D280,039 S	8/1985	Strayer		
5,064,012 A *	11/1991	Losego	.....	180/19.1
5,265,892 A *	11/1993	Said	.....	280/30

5,649,718 A	7/1997	Groglio		
6,024,527 A	2/2000	Soriano		
6,045,150 A	4/2000	Al-Toukhi		
6,070,899 A	6/2000	Gines		
D444,927 S *	7/2001	Lin	.....	D32/37
6,328,329 B1 *	12/2001	Smith	.....	280/639
6,575,491 B2	6/2003	Miller		
6,598,898 B2 *	7/2003	Chu	.....	280/652
6,749,207 B2	6/2004	Nadeau		
6,889,998 B2	5/2005	Sterns et al.		
6,932,363 B2	8/2005	D'Angelo		
D525,758 S *	7/2006	Lynch	.....	D34/12
D573,772 S *	7/2008	Faehnle	.....	D34/17

\* cited by examiner

*Primary Examiner*—Cynthia E Ramirez

(57) **CLAIM**

The ornamental design for a cart device, as shown.

**DESCRIPTION**

FIG. 1 is a perspective view of a cart device;  
FIG. 2 is a side view thereof;  
FIG. 3 is a back view thereof;  
FIG. 4 is a front view thereof;  
FIG. 5 is a top view thereof; and,  
FIG. 6 is a bottom view thereof.

**1 Claim, 4 Drawing Sheets**

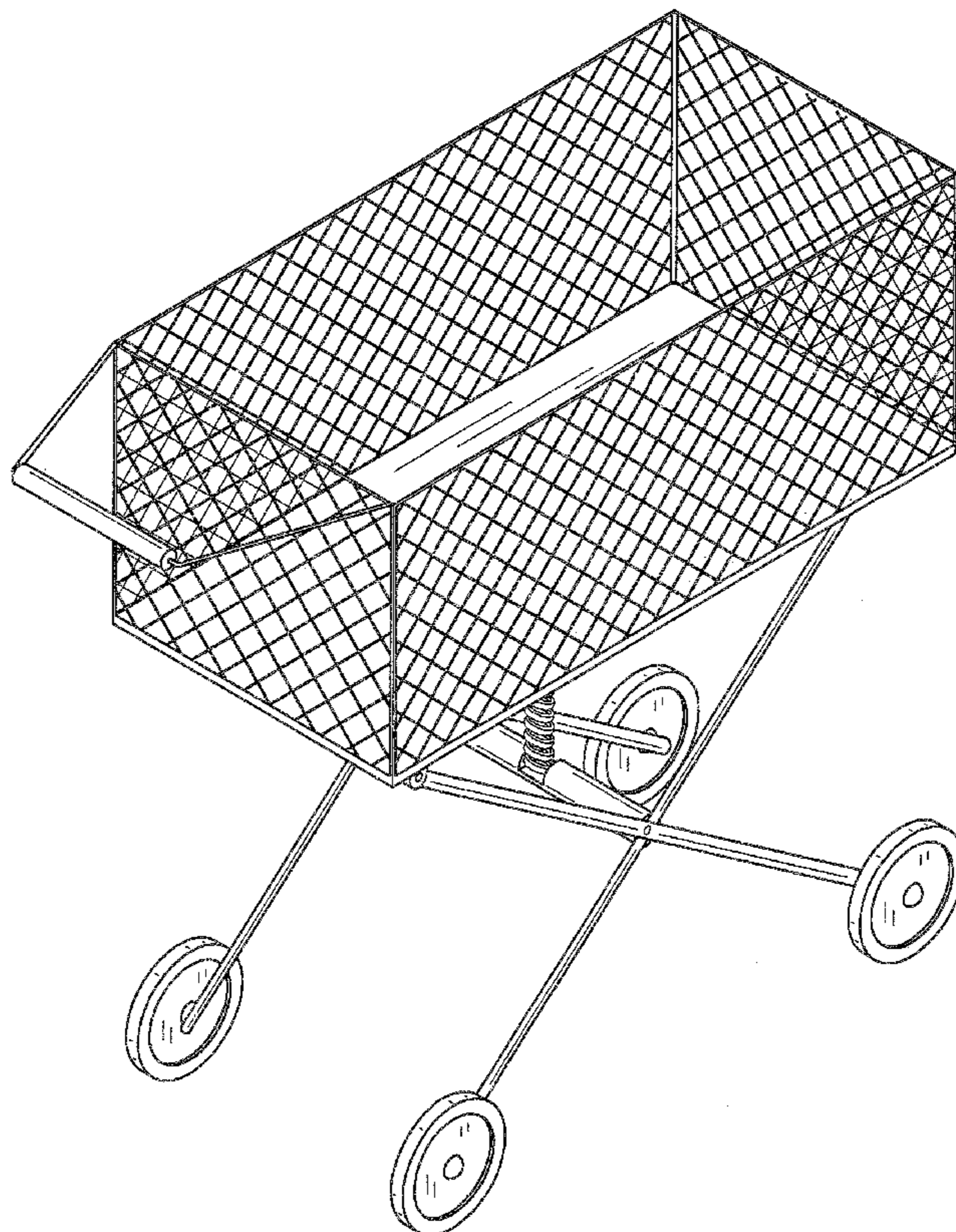

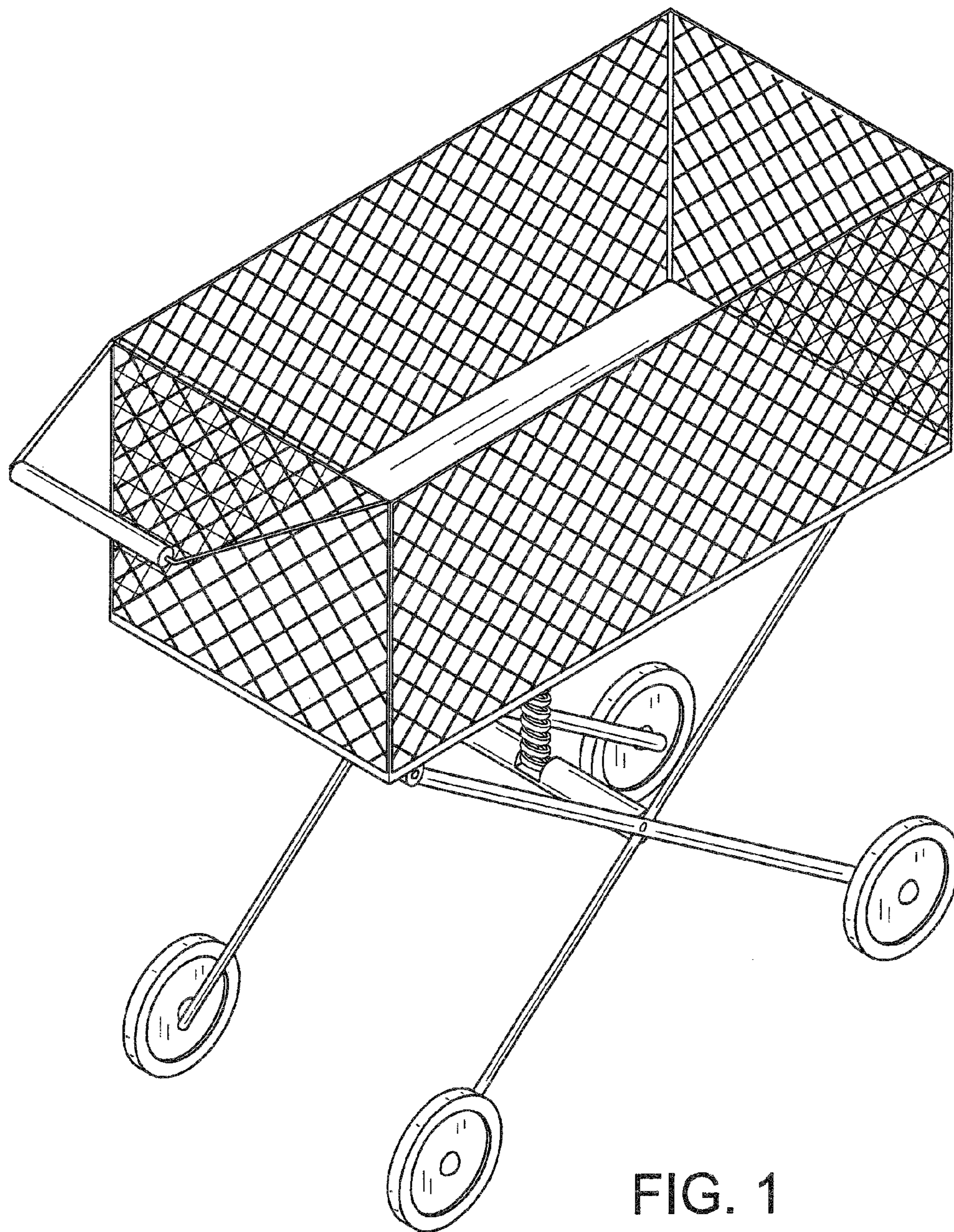

FIG. 1

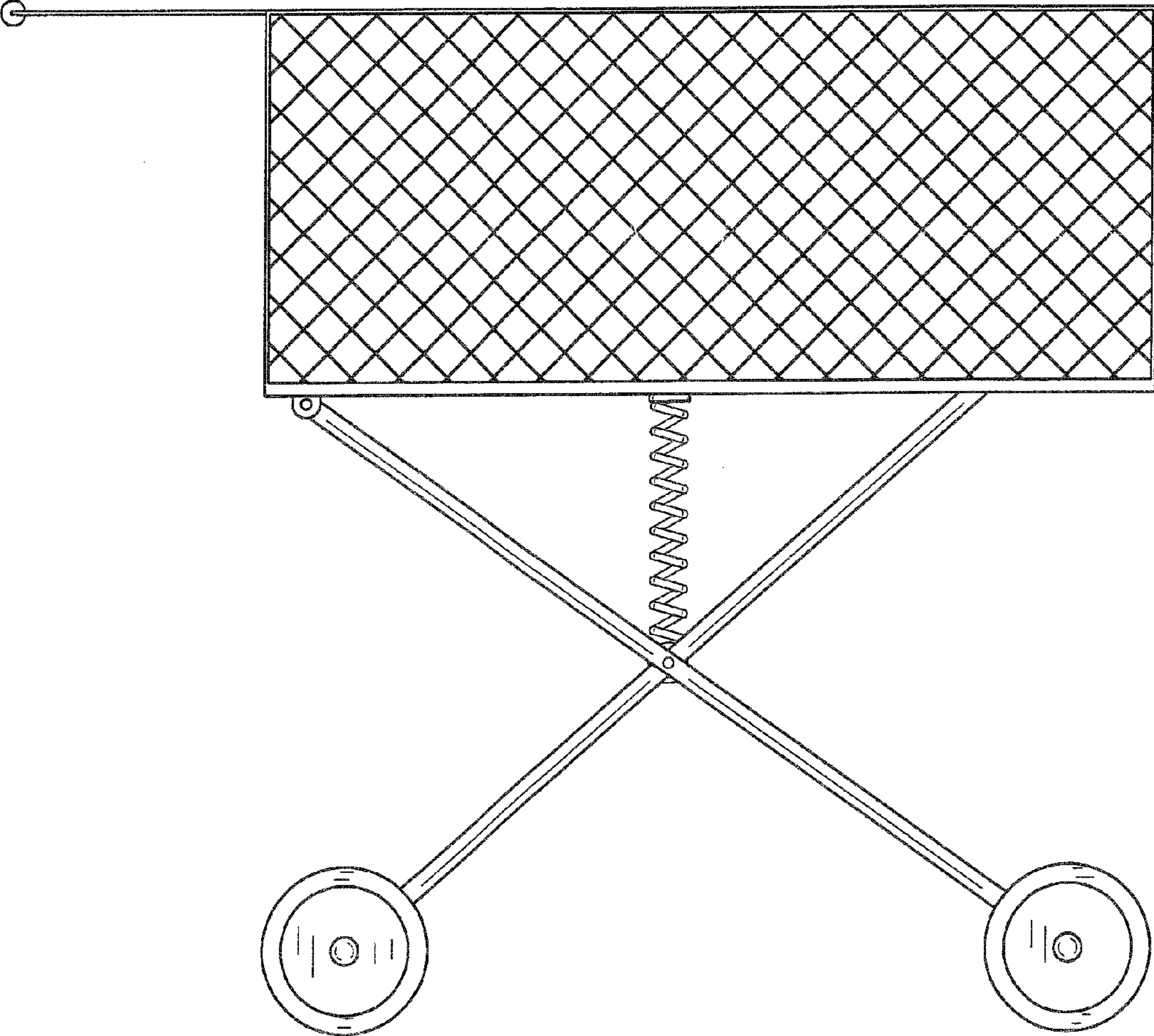

FIG. 2

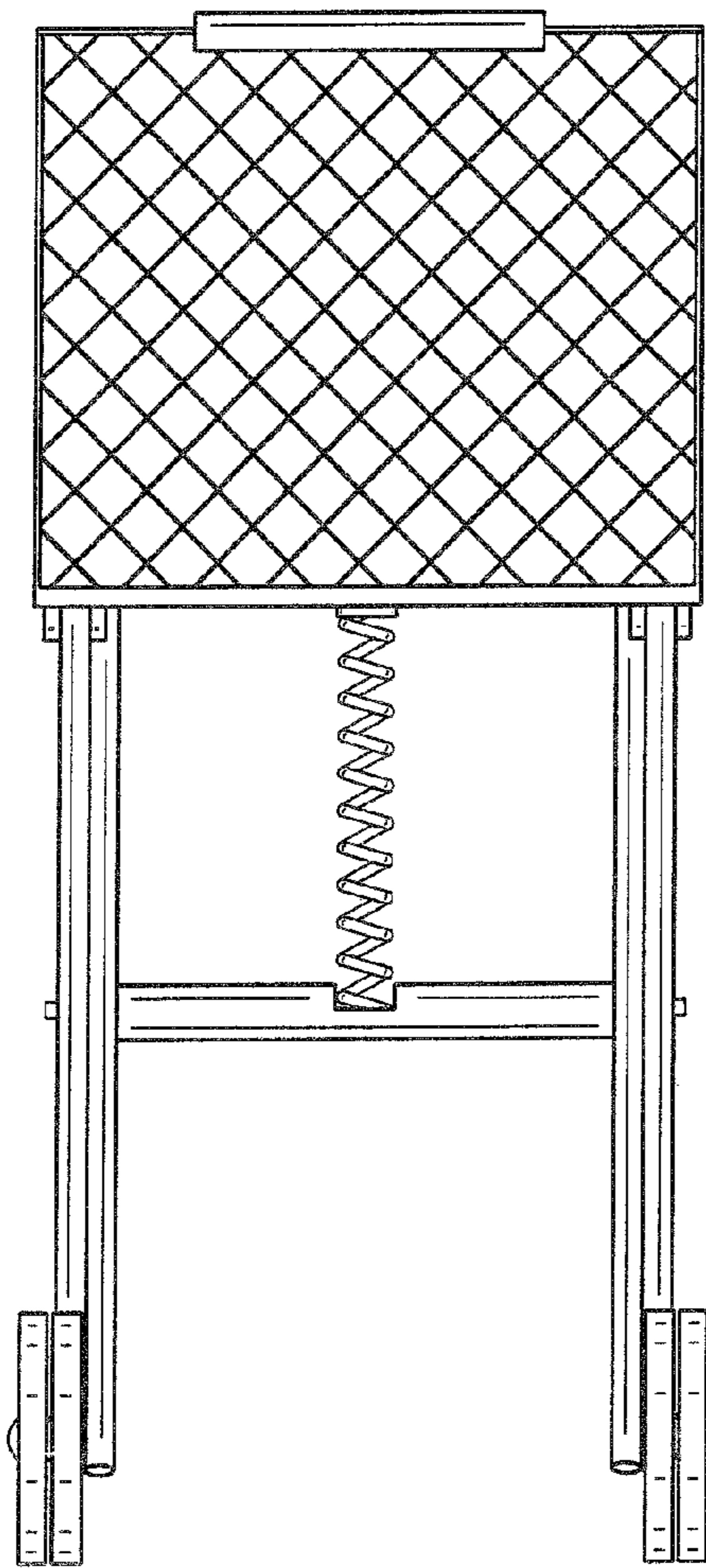

FIG. 3

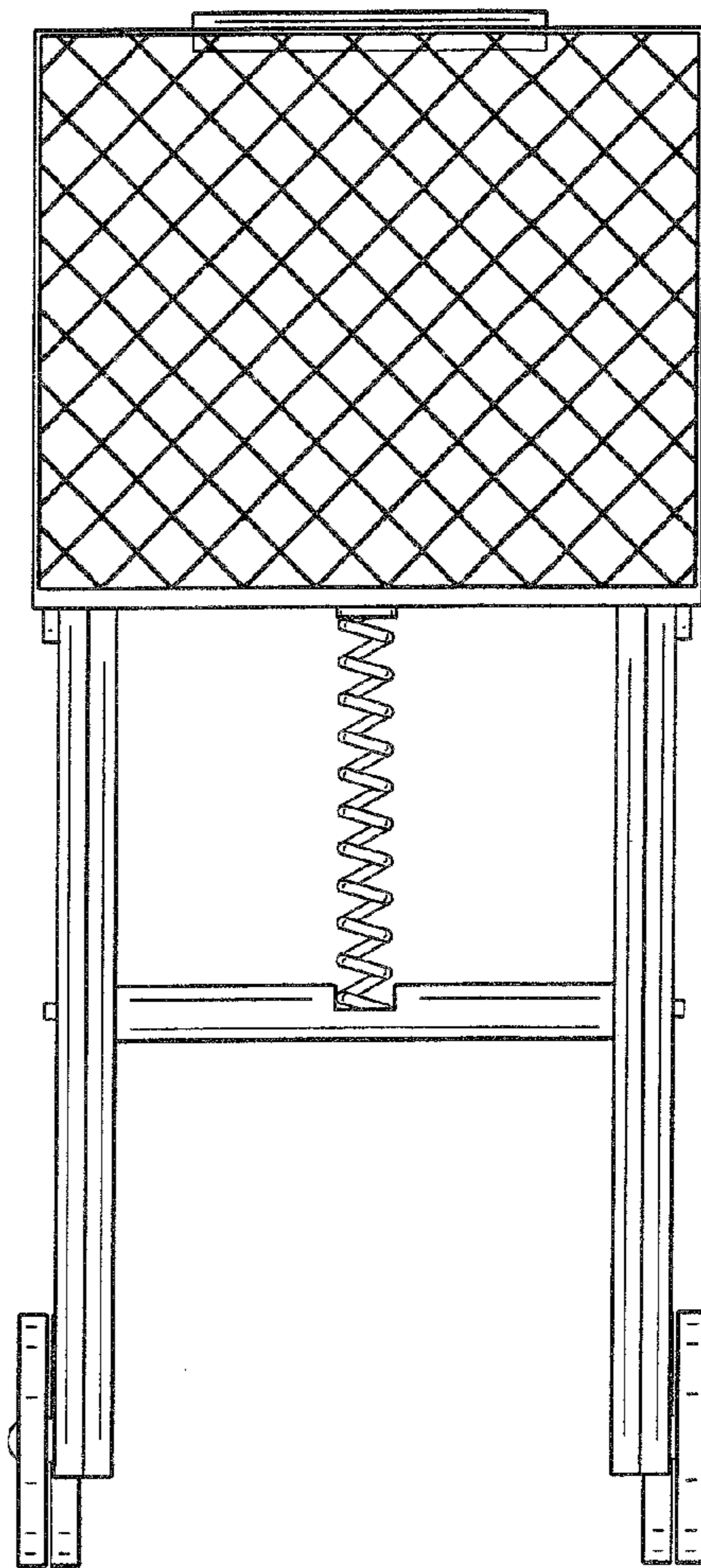

FIG. 4

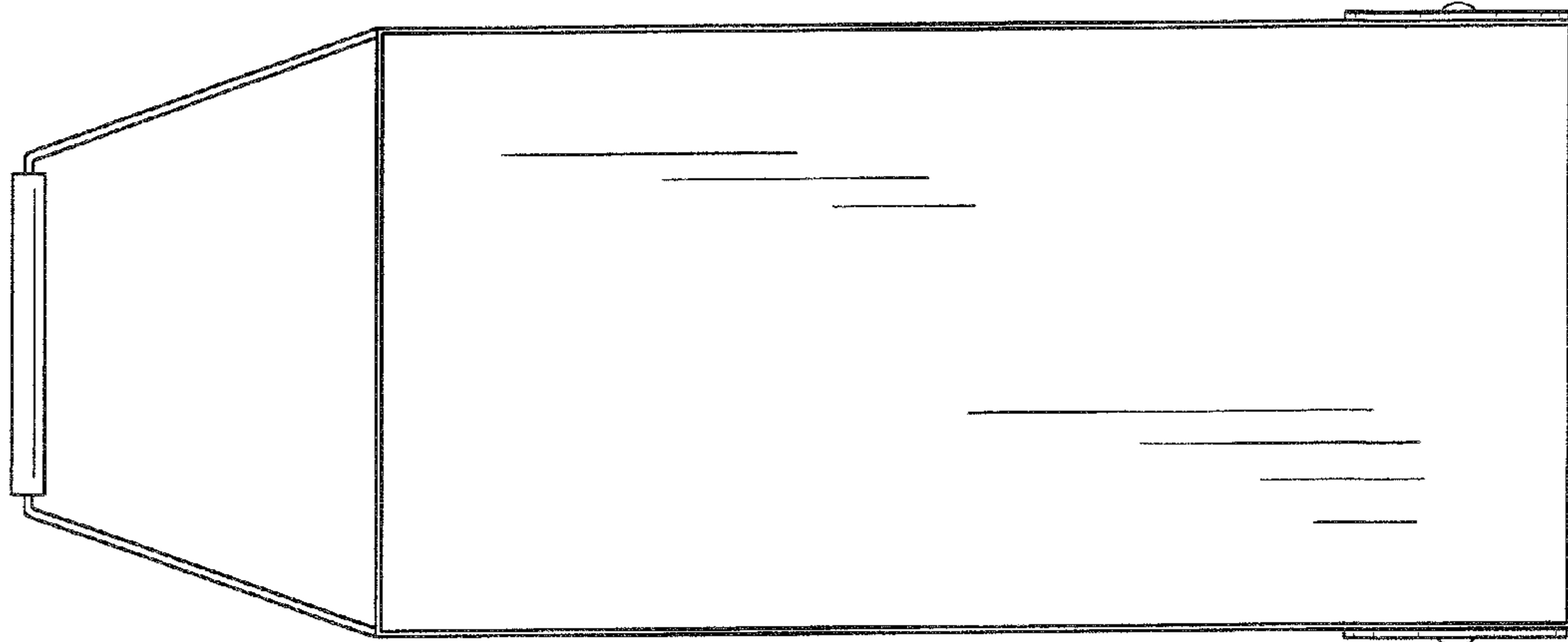

FIG. 5

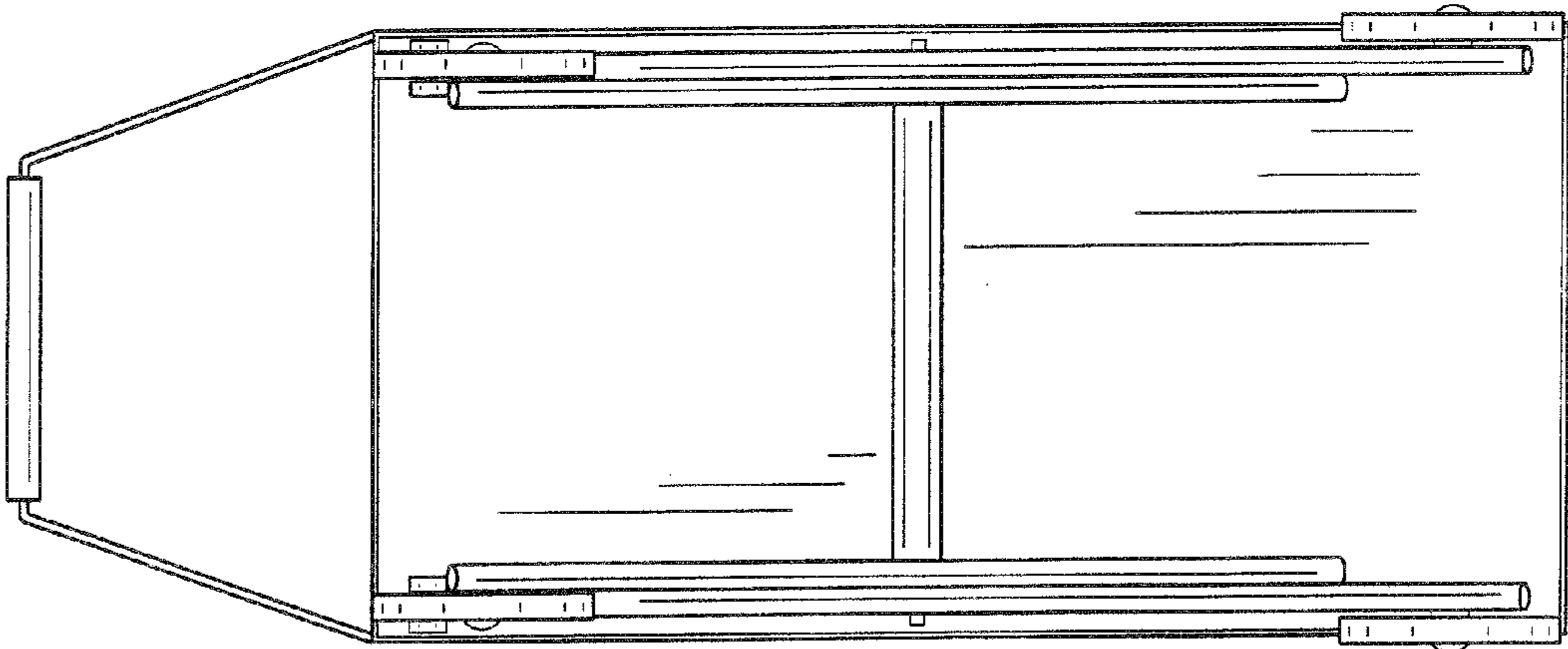

FIG. 6