



US00D601738S

(12) **United States Design Patent**
Schneider

(10) **Patent No.:** **US D601,738 S**

(45) **Date of Patent:** **** Oct. 6, 2009**

(54) **BOLLARD LED**

(75) Inventor: **Jean-Marc Schneider**, Annecy-le-Vieux (FR)

(73) Assignee: **Hess AG Form + Licht, P.C.**, Villingen-Schwenningen (DE)

(**) Term: **14 Years**

(21) Appl. No.: **29/324,707**

(22) Filed: **Sep. 18, 2008**

(30) **Foreign Application Priority Data**

Apr. 20, 2008 (EP) 000914023

(51) **LOC (9) Cl.** **26-05**

(52) **U.S. Cl.** **D26/71**

(58) **Field of Classification Search** D26/67-72,
D26/85, 92; 362/145, 152, 183, 294, 373,
362/414, 431, 545, 800

See application file for complete search history.

(56) **References Cited**

U.S. PATENT DOCUMENTS

D214,584 S * 7/1969 Routh et al. D26/63
D231,680 S * 5/1974 Keller D26/68
D239,861 S * 5/1976 Steenhoven D26/71
D306,909 S * 3/1990 Kelley et al. D26/24
D340,049 S * 10/1993 Liljenwall et al. D26/68
D385,643 S * 10/1997 Brohard et al. D26/71

D418,619 S * 1/2000 Porter D26/68
D555,279 S * 11/2007 Schneider D26/71
D576,331 S * 9/2008 Ruud et al. D26/71
D591,445 S * 4/2009 Guercio D26/92

OTHER PUBLICATIONS

Fel Group modern contemporary area and road lighting fixtures. Ascent, Canto, Capella and Icon. All found at felgroup.co.nz on Mar. 25, 2009.*

* cited by examiner

Primary Examiner—Clare E Heflin

(74) *Attorney, Agent, or Firm*—McGlew and Tuttle, P.C.

(57) **CLAIM**

The ornamental design for a bollard LED, as shown and described.

DESCRIPTION

FIG. 1 is a right side view of my new bollard LED design;

FIG. 2 is a rear view thereof;

FIG. 3 is a left side view thereof;

FIG. 4 is a front view thereof;

FIG. 5 is a top view thereof;

FIG. 6 is a rear perspective view thereof;

FIG. 7 is a front and bottom perspective view thereof; and,

FIG. 8 is a bottom view thereof.

1 Claim, 4 Drawing Sheets

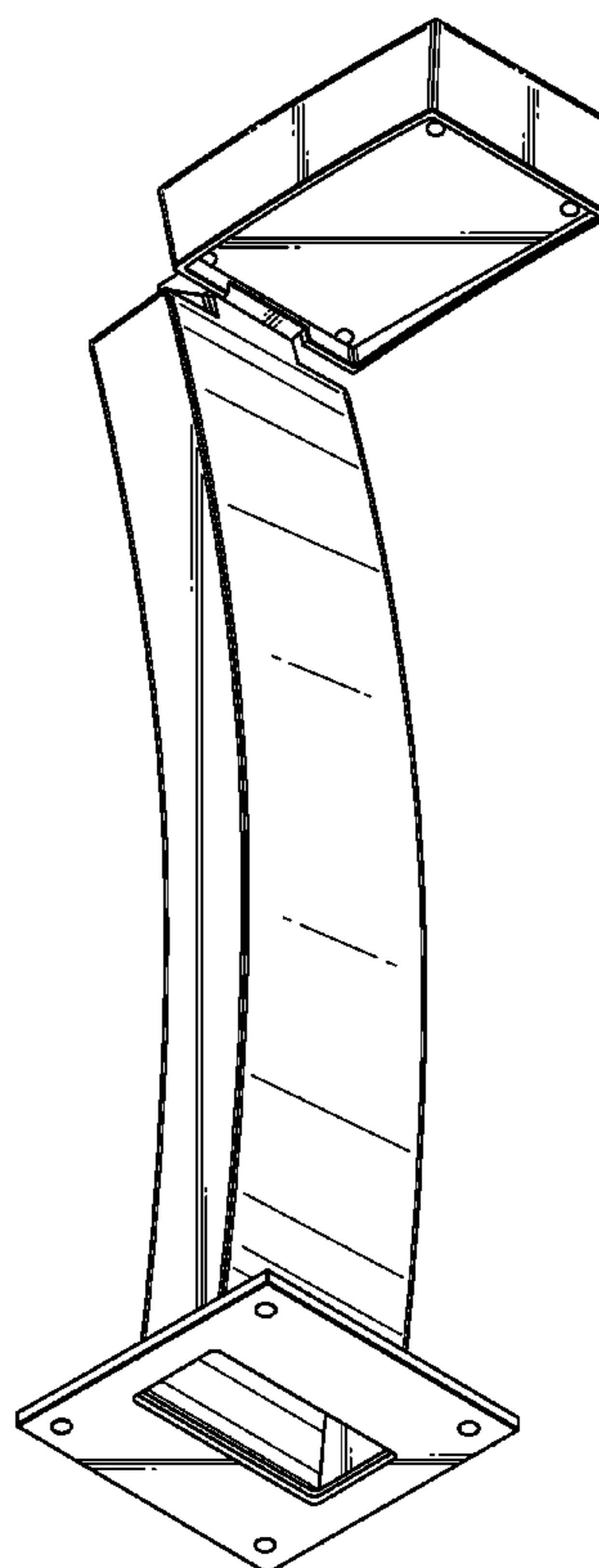
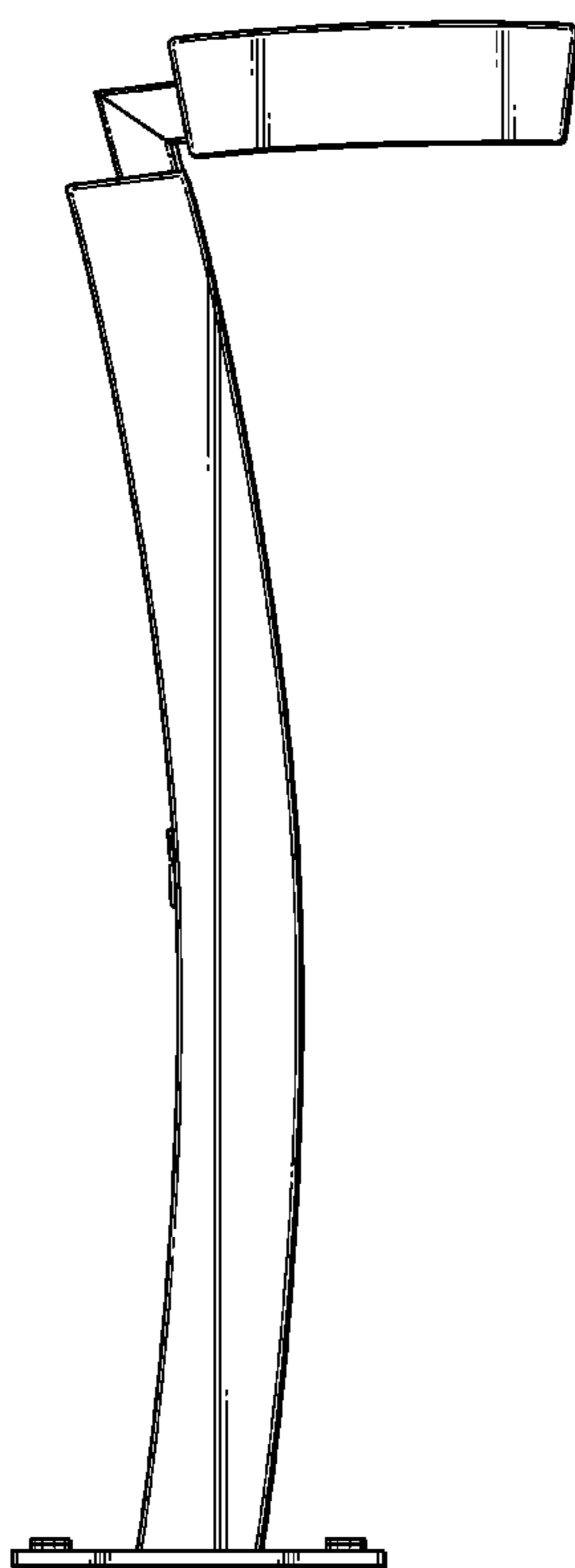

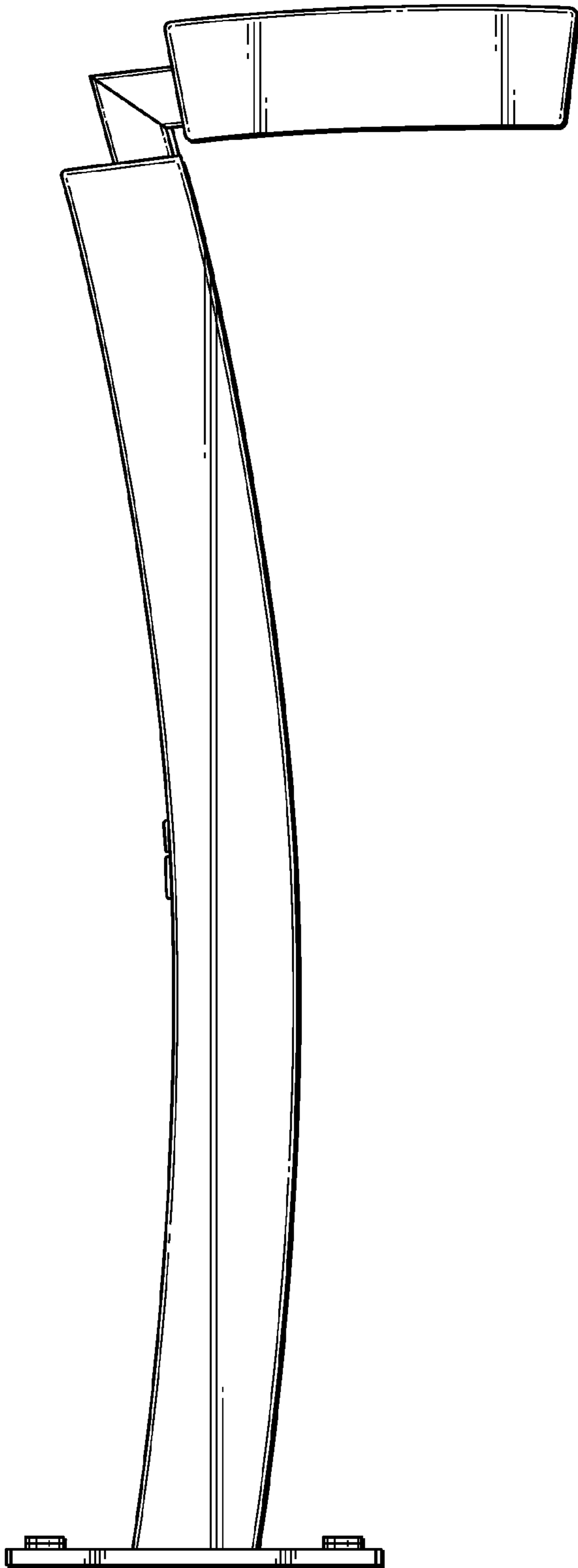

FIG. 1

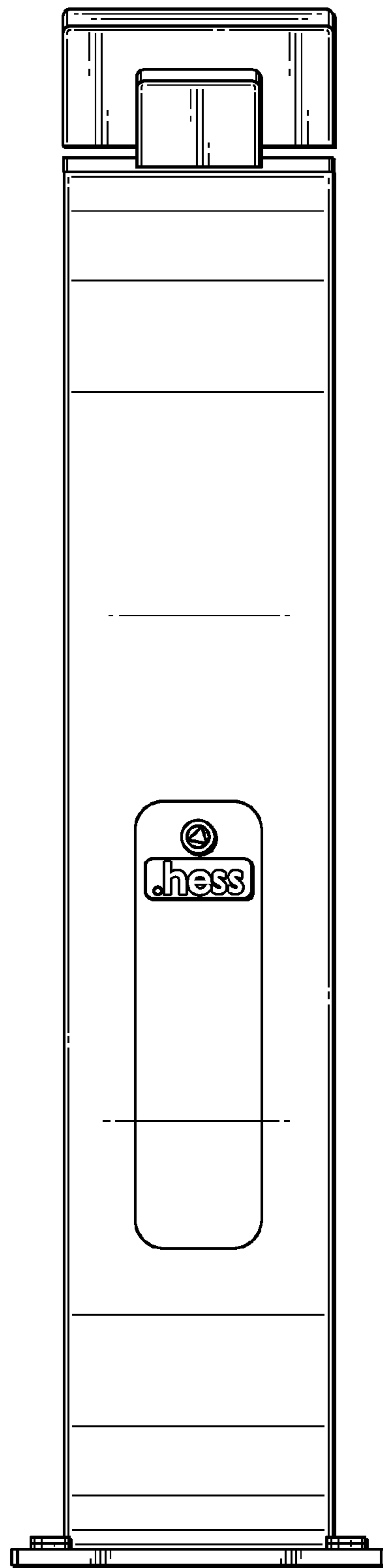

FIG. 2

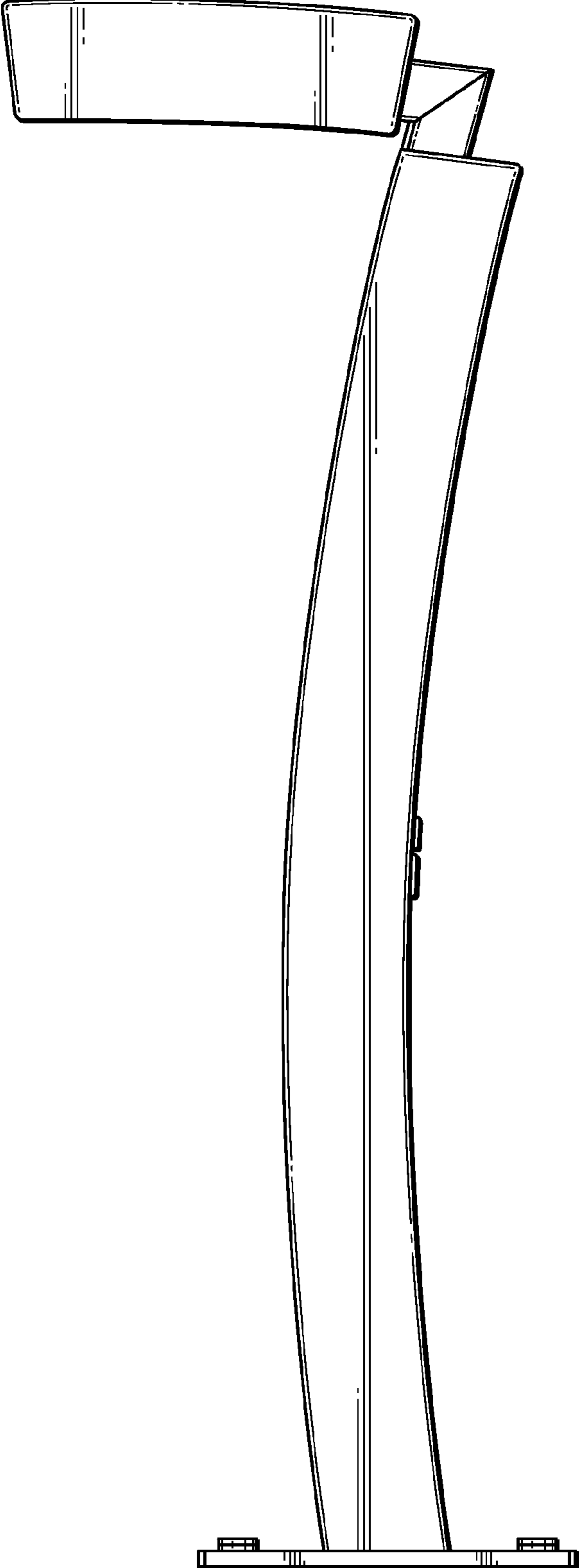

FIG. 3

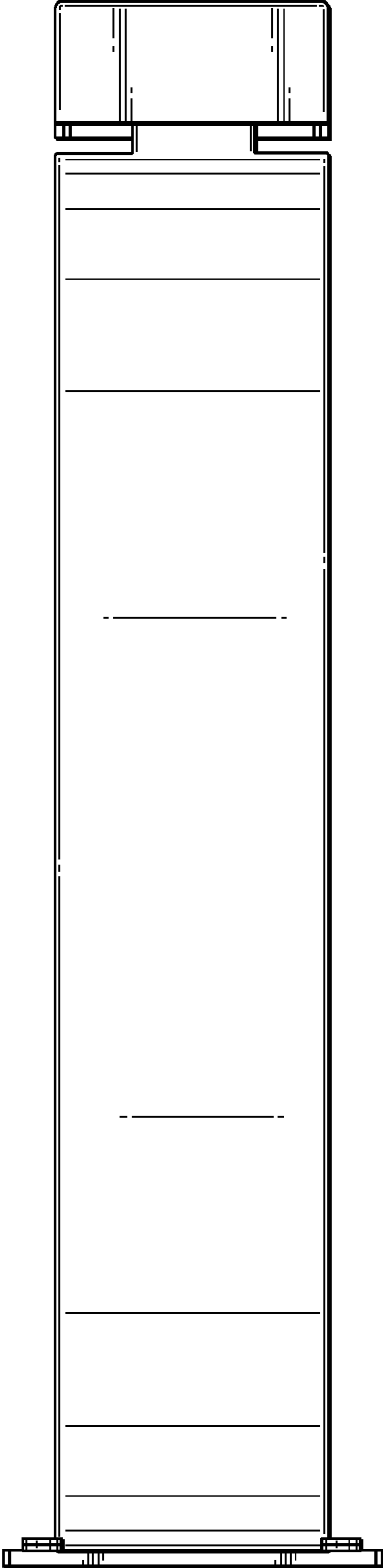

FIG. 4

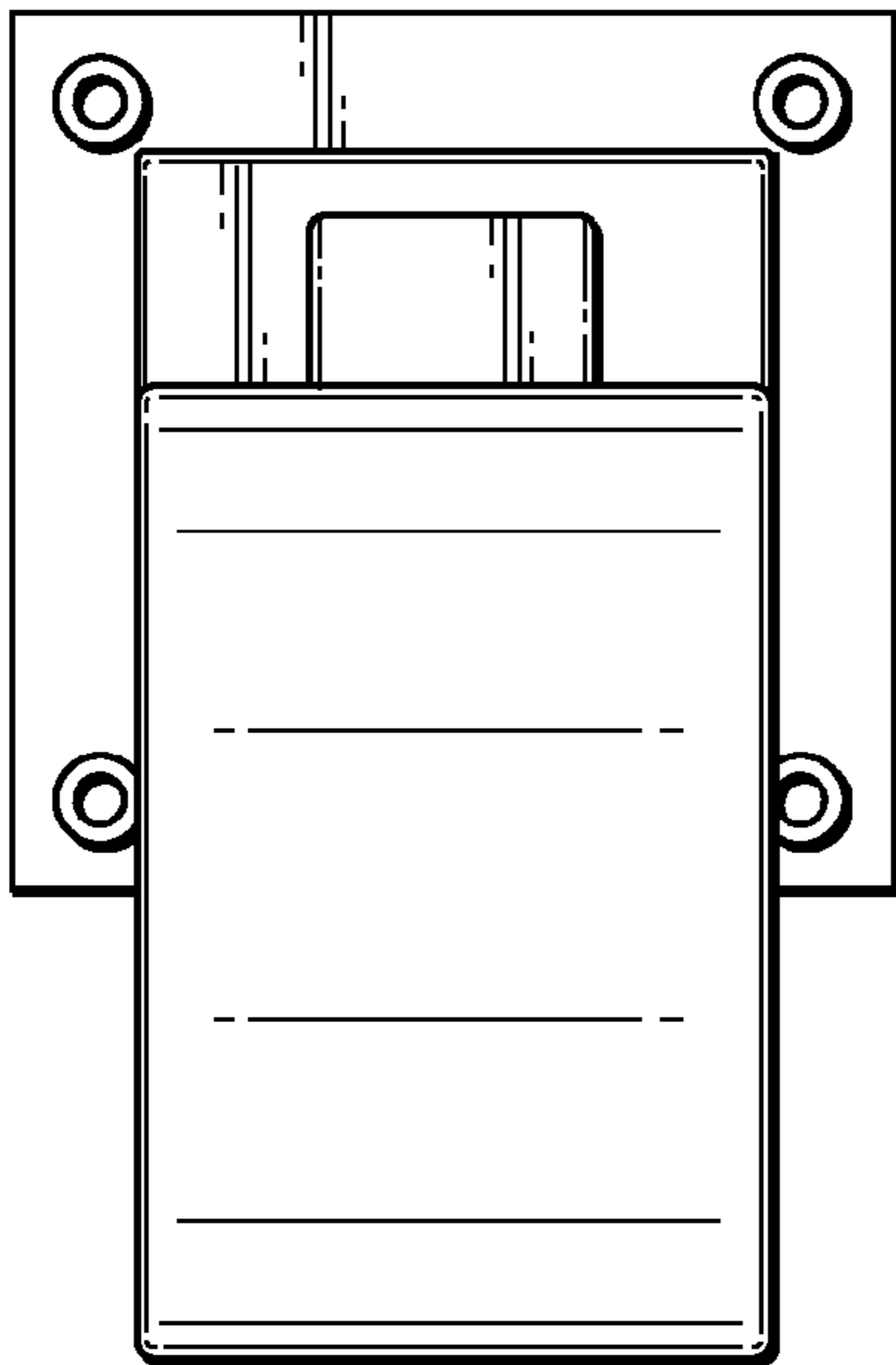

FIG. 5

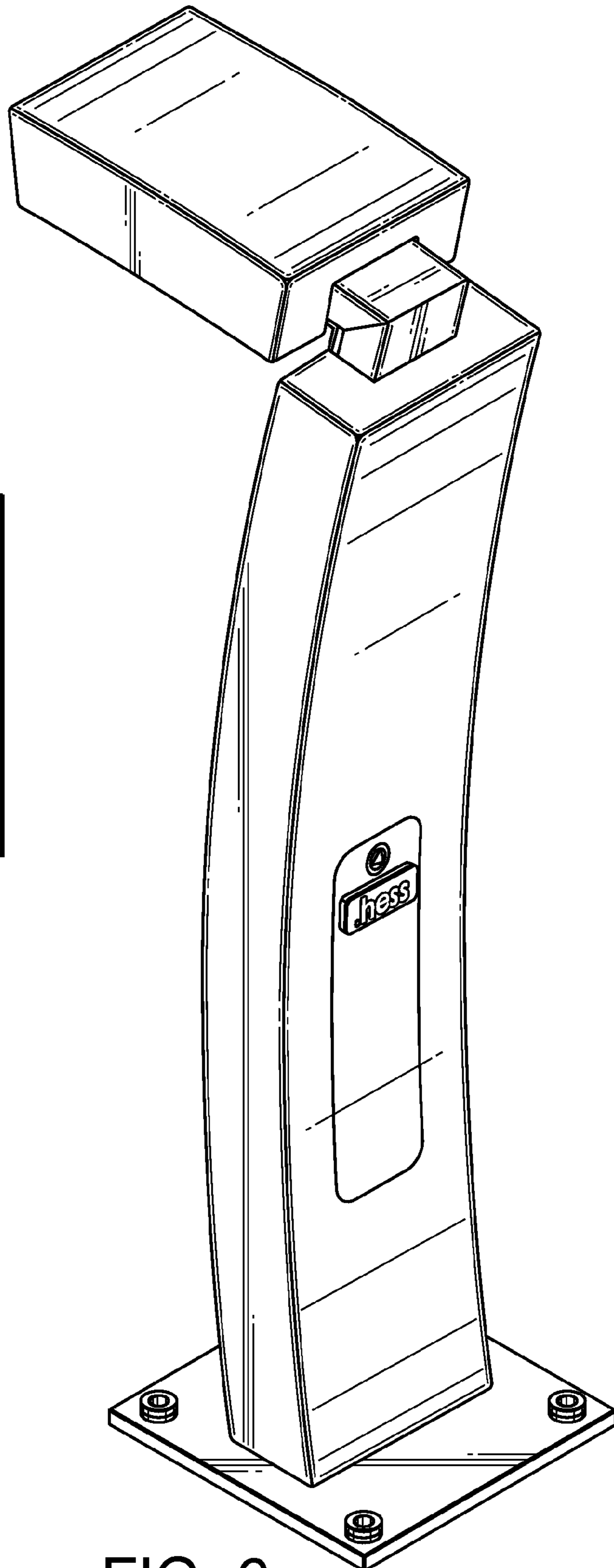

FIG. 6

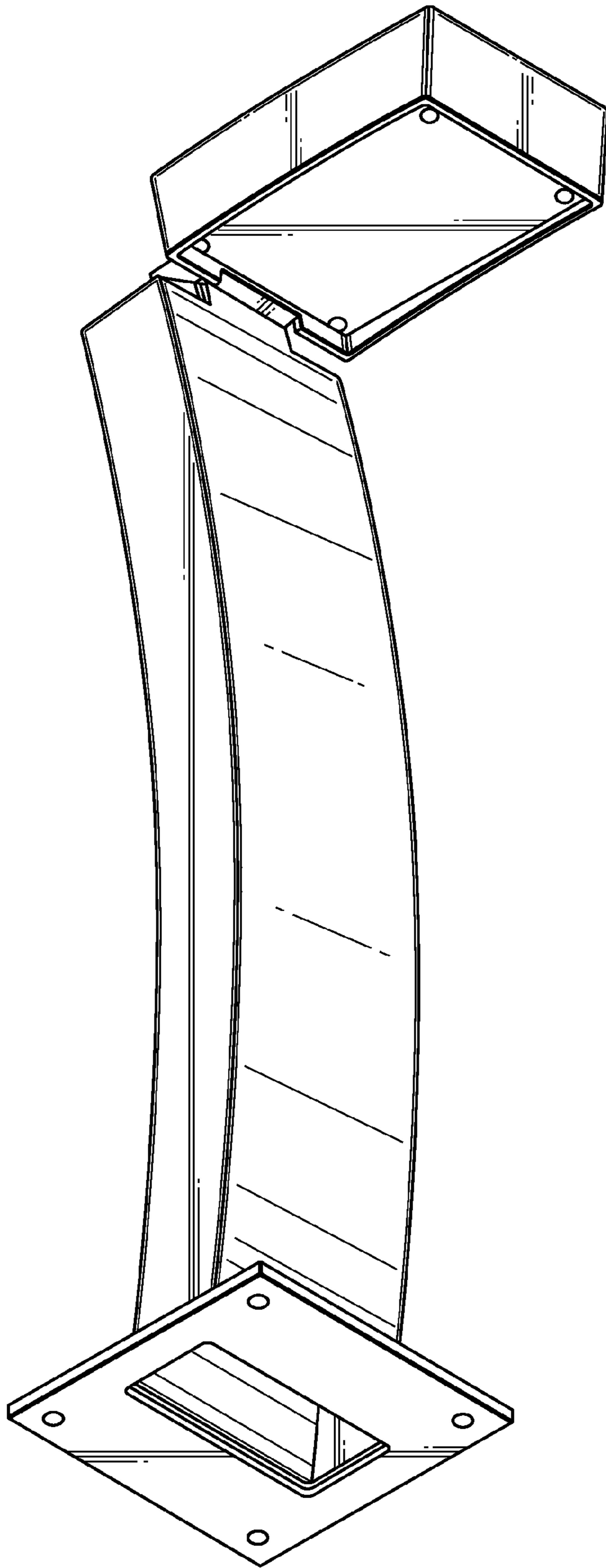

FIG. 7

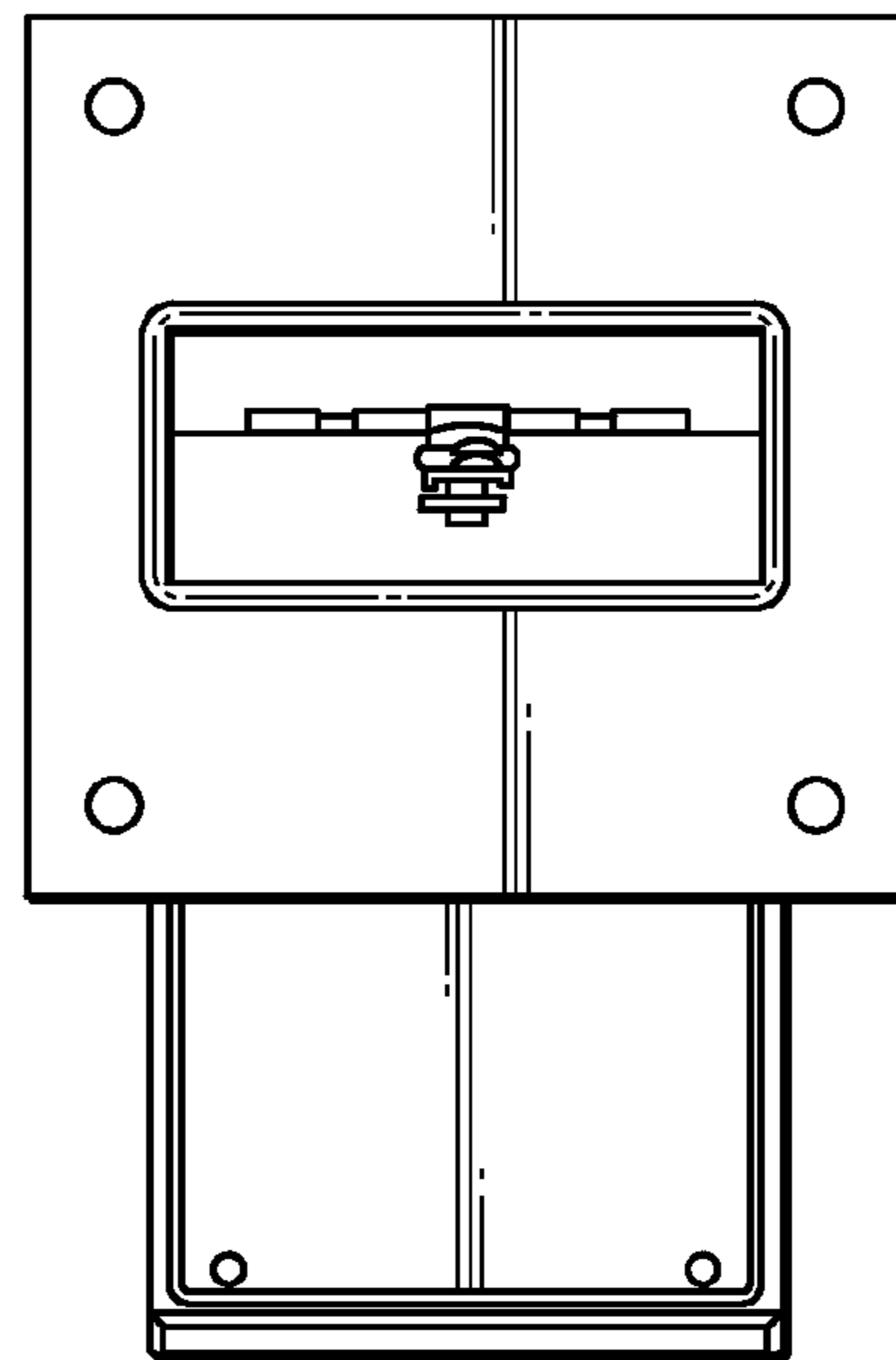

FIG. 8

UNITED STATES PATENT AND TRADEMARK OFFICE
CERTIFICATE OF CORRECTION

PATENT NO. : Des. 601,738 S
APPLICATION NO. : 29/324707
DATED : October 6, 2009
INVENTOR(S) : Jean-Marc Schneider

Page 1 of 1

It is certified that error appears in the above-identified patent and that said Letters Patent is hereby corrected as shown below:

Title Page should read

(73) Assignee: Hess AG Form + Licht

Signed and Sealed this

Twenty-third Day of February, 2010

A handwritten signature in black ink that reads "David J. Kappos". The signature is written in a cursive style with a large initial 'D' and a stylized 'K'.

David J. Kappos
Director of the United States Patent and Trademark Office