



US00D601727S

(12) **United States Design Patent**
Huang

(10) **Patent No.:** **US D601,727 S**

(45) **Date of Patent:** **** Oct. 6, 2009**

(54) **VEHICLE LAMP**

(75) Inventor: **Cheng-Nan Huang**, Rende Township
(TW)

(73) Assignee: **Sirius Light Technology Co., Ltd.**,
Tainan (TW)

(**) Term: **14 Years**

(21) Appl. No.: **29/314,229**

(22) Filed: **Mar. 16, 2009**

(30) **Foreign Application Priority Data**

Nov. 27, 2008 (TW) 97306745

(51) **LOC (9) Cl.** **26-06**

(52) **U.S. Cl.** **D26/28**

(58) **Field of Classification Search** D26/28-36;
362/459-468, 475-478, 485-487
See application file for complete search history.

(56) **References Cited**

U.S. PATENT DOCUMENTS

D547,889 S * 7/2007 Huang D26/28

D570,012 S * 5/2008 Huang D26/28

D574,978 S * 8/2008 Hyodo et al. D26/28

D578,677 S * 10/2008 Huang D26/28

D578,678 S * 10/2008 Huang D26/28

D585,575 S * 1/2009 Crispin et al. D26/28

* cited by examiner

Primary Examiner—Marcus A. Jackson

(74) *Attorney, Agent, or Firm*—Dillon & Yudell LLP

(57) **CLAIM**

The ornamental design for vehicle lamp, as shown and described.

DESCRIPTION

FIG. 1 is a perspective view of vehicle lamp showing my new design;

FIG. 2 is a front elevational view thereof;

FIG. 3 is a rear elevational view thereof;

FIG. 4 is a left side elevational view thereof;

FIG. 5 is a right side elevational view thereof;

FIG. 6 is a top plan view thereof; and,

FIG. 7 is a bottom plan view thereof.

1 Claim, 6 Drawing Sheets

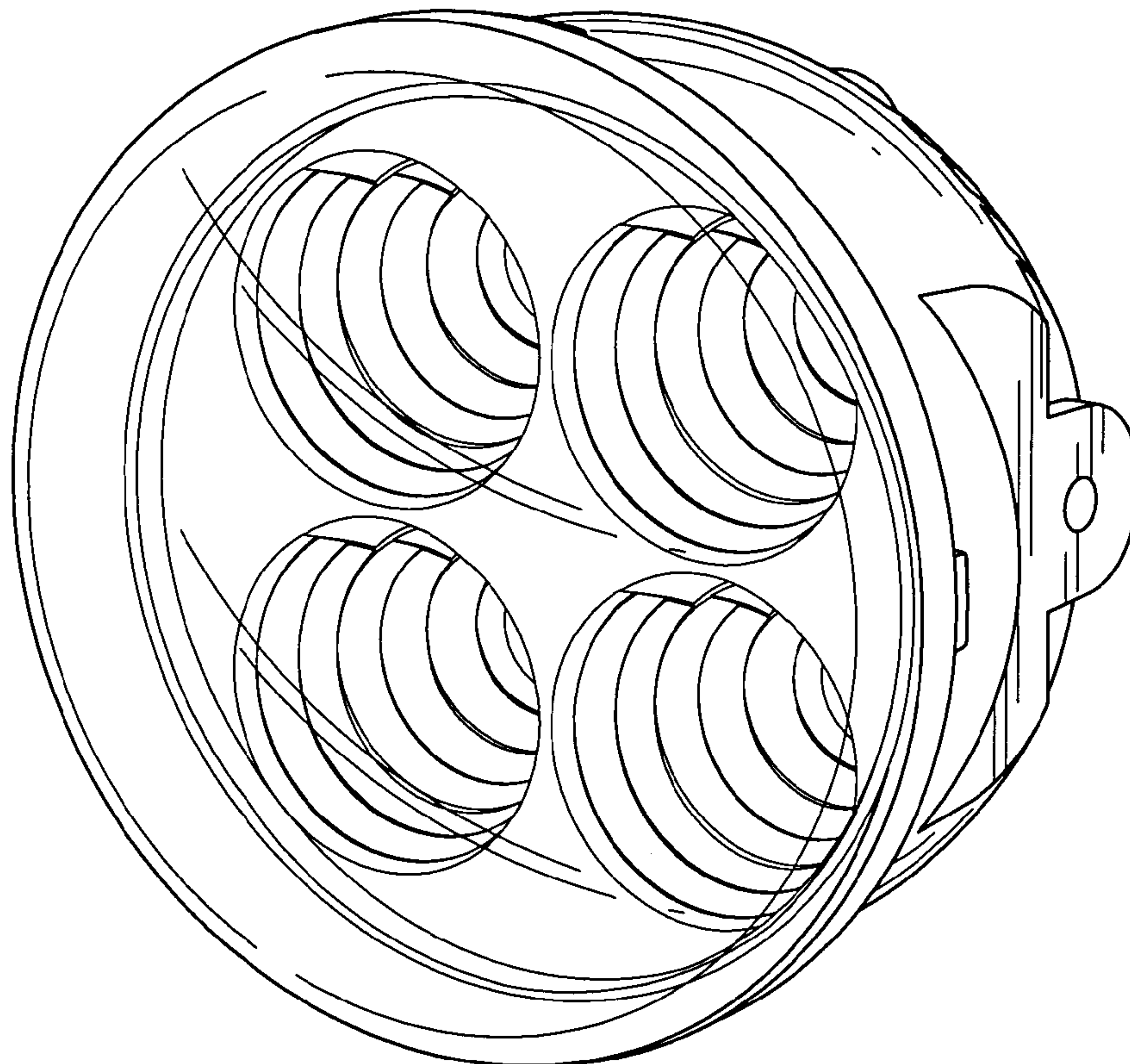

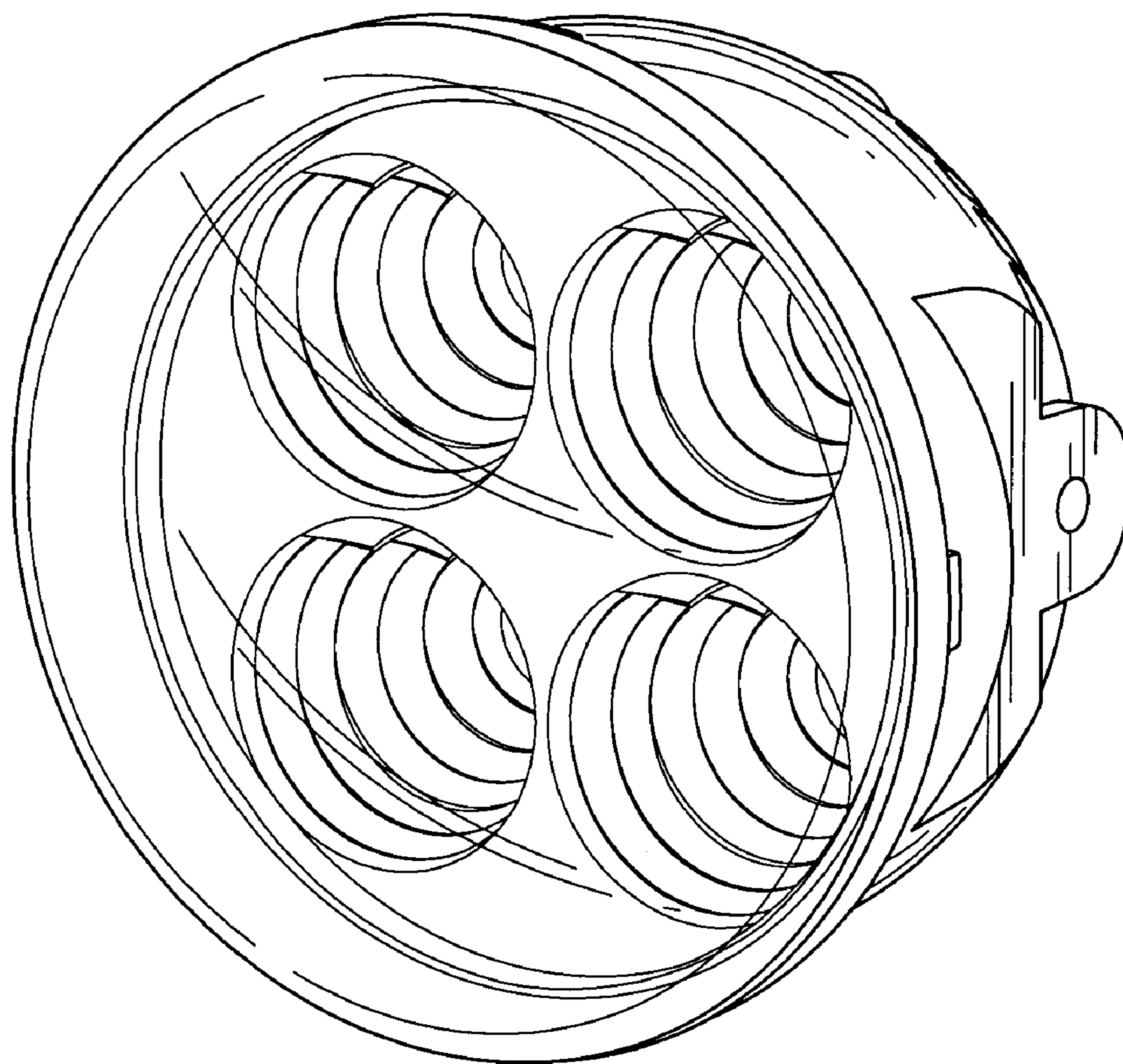

FIG. 1

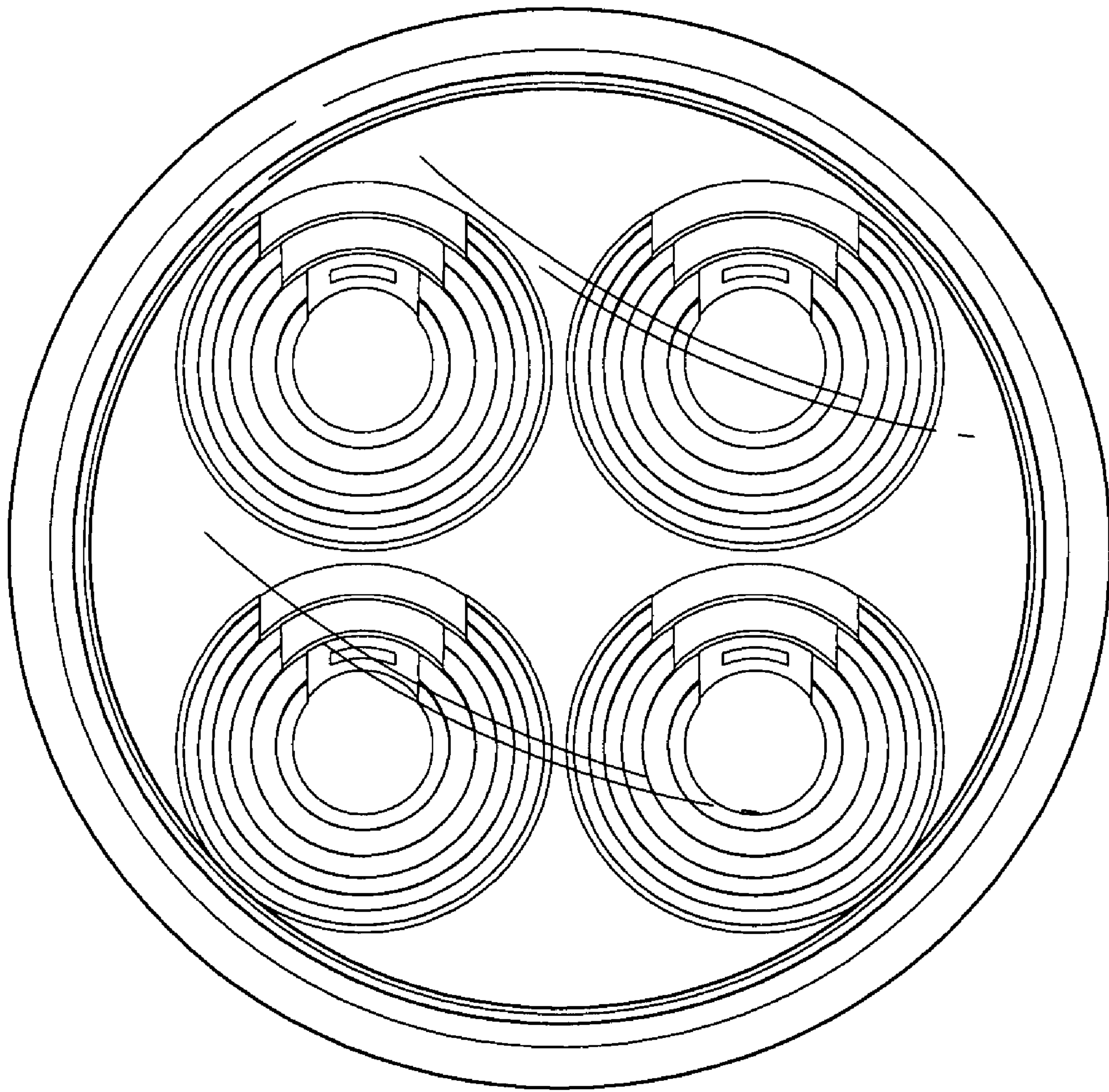

FIG. 2

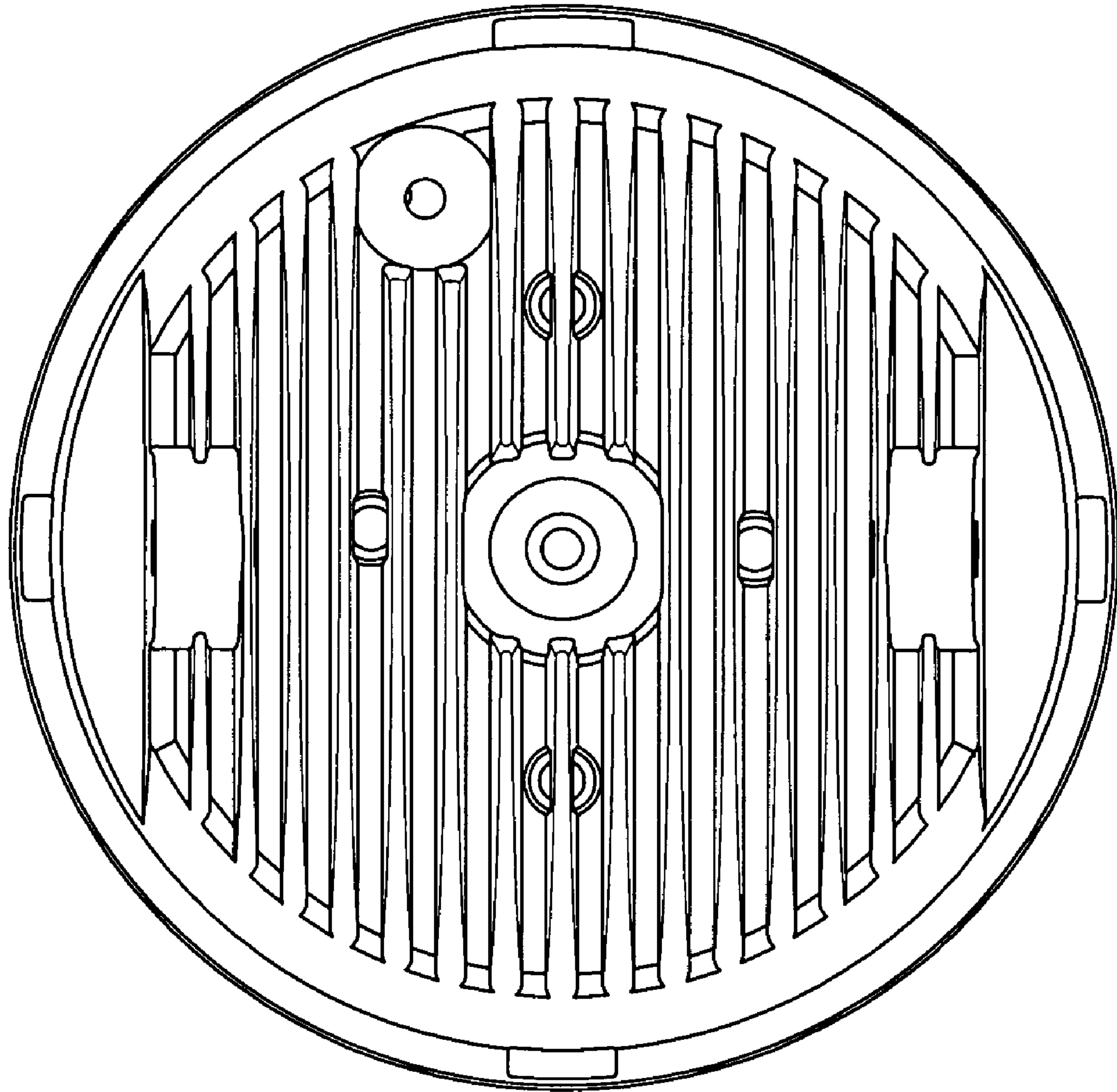

FIG. 3

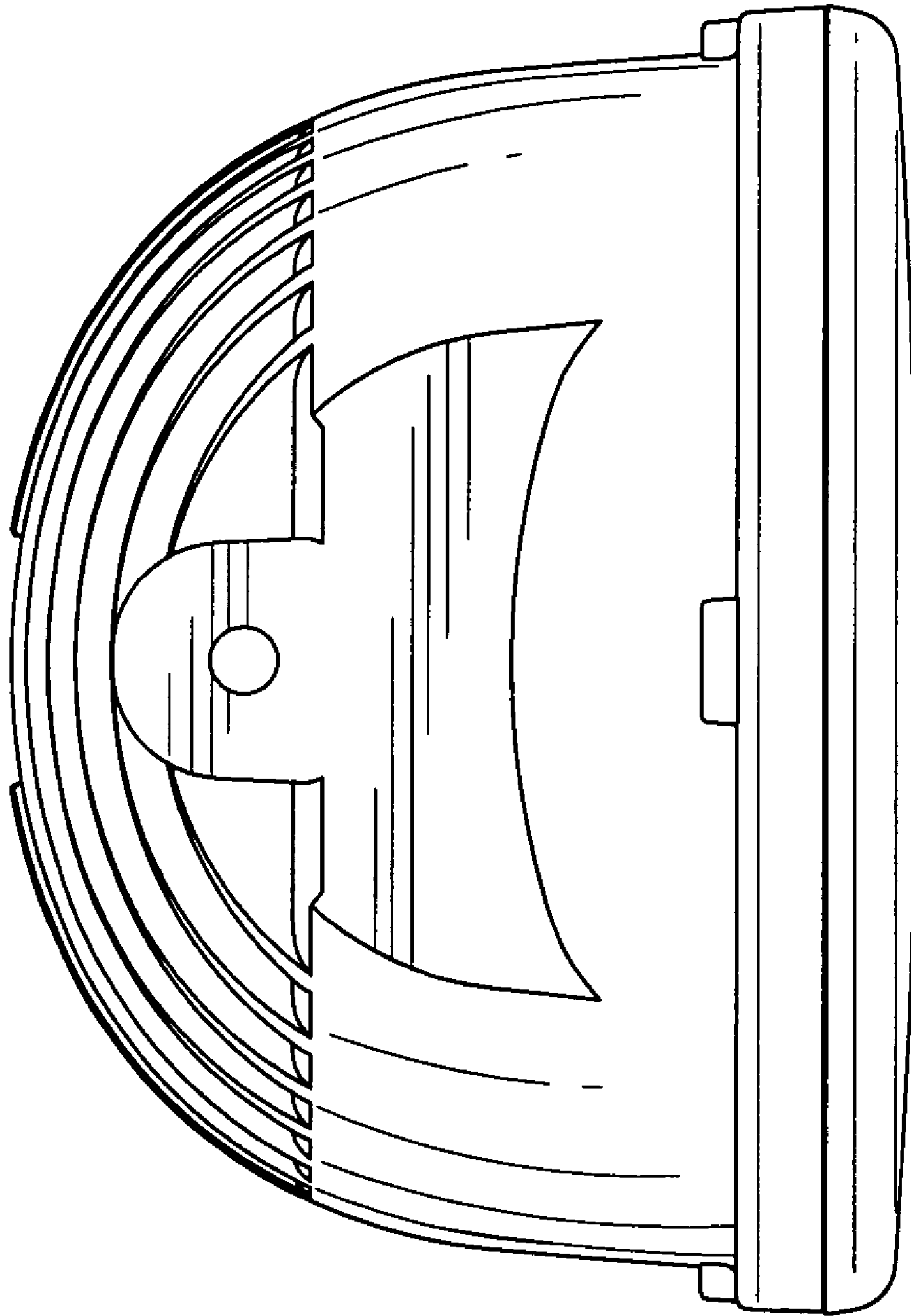

FIG. 4

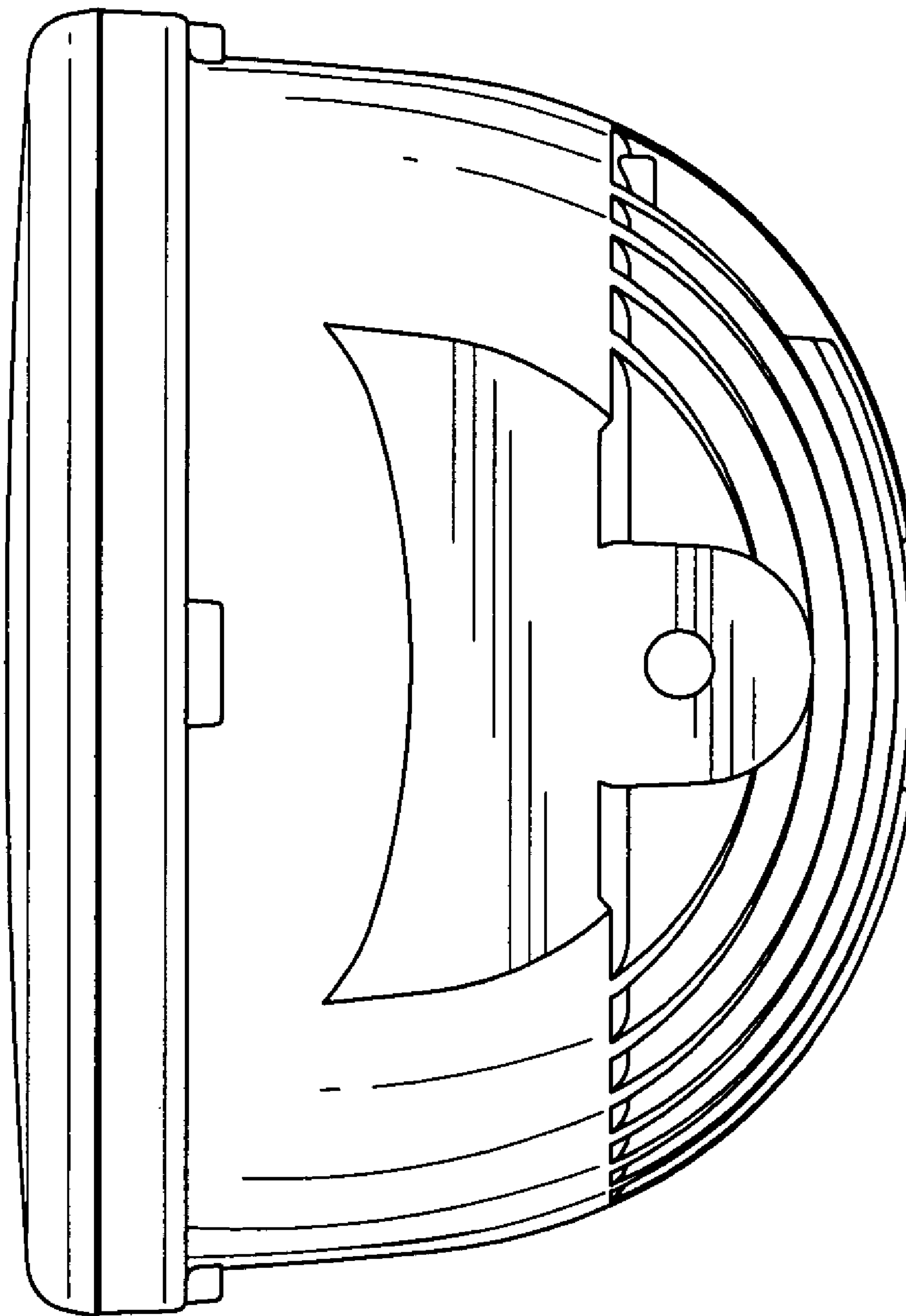

FIG. 5

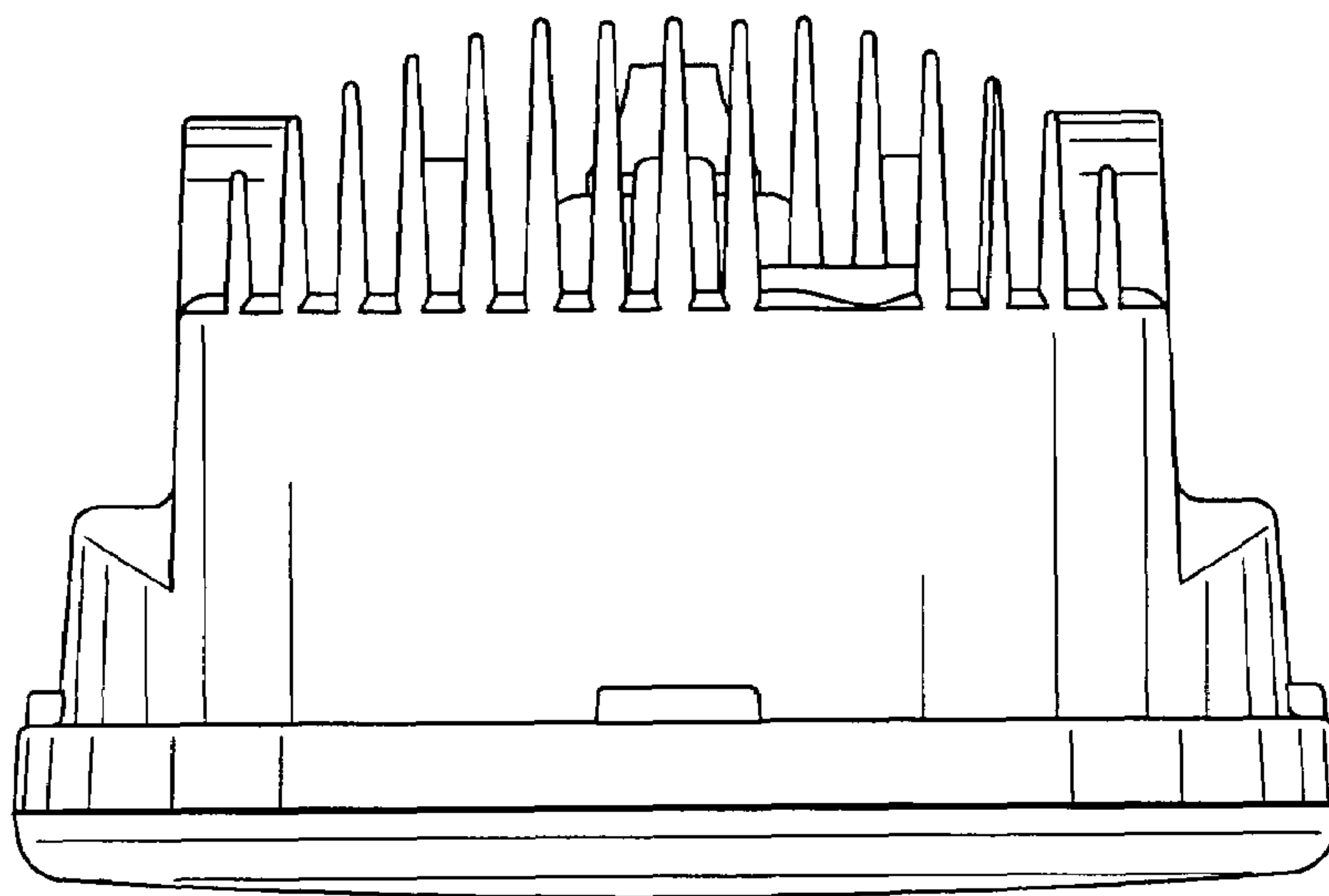

FIG. 6

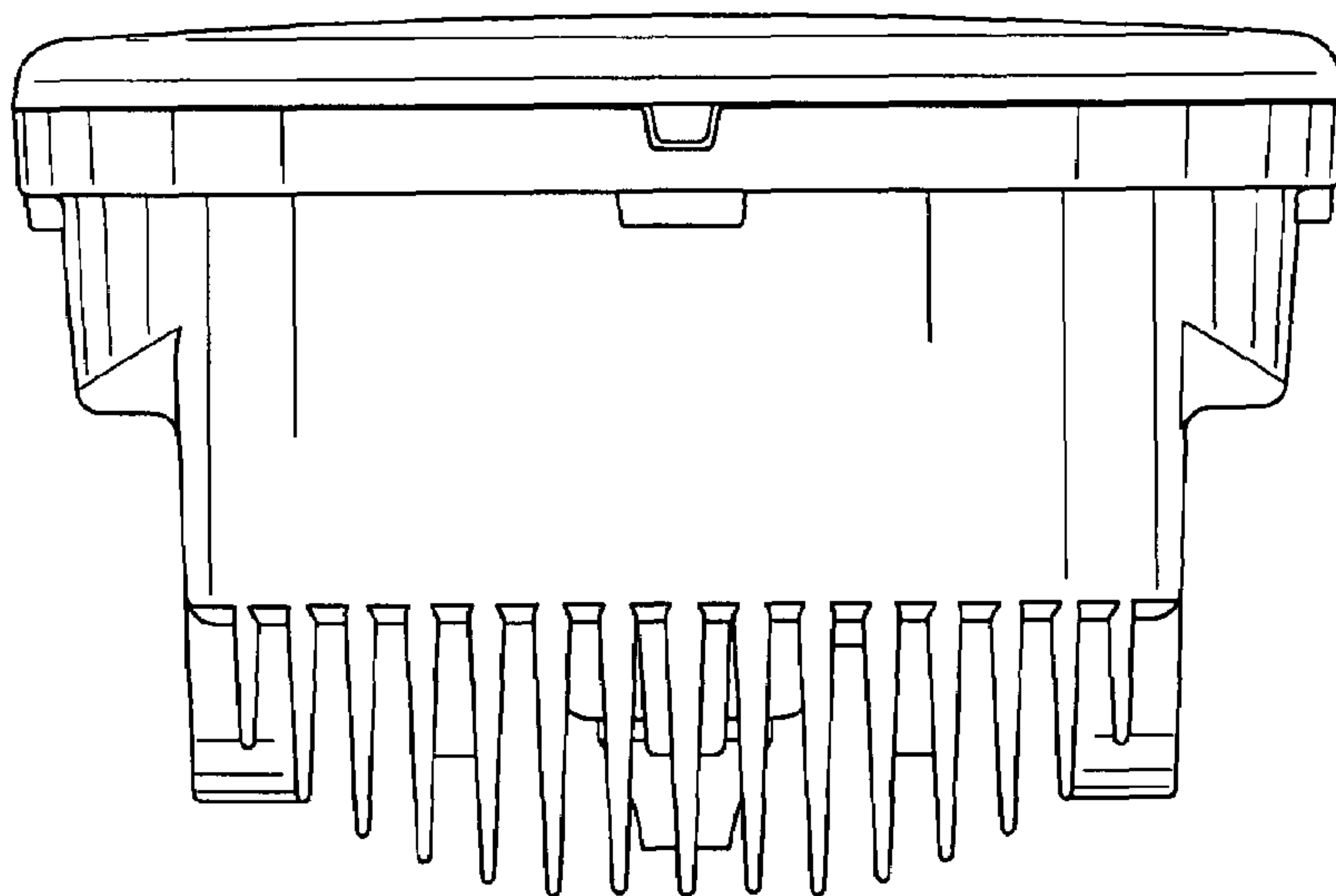

FIG. 7