

US00D601703S

(12) **United States Design Patent**
Kahdemann

(10) **Patent No.:** **US D601,703 S**

(45) **Date of Patent:** **** Oct. 6, 2009**

(54) **DENTAL IMPLANT**

D565,181 S * 3/2008 Anitua Aldecoa D24/156
7,425,131 B2 * 9/2008 Amber et al. 433/173

(75) Inventor: **Steffen Kahdemann**, Uffenheim (DE)

OTHER PUBLICATIONS

(73) Assignee: **ziterion, GmbH**, Uffenheim Alemania (DE)

Internet website entitled "Zimmer Dental: Features and Benefits: Tapered Swiss Plus", http://www.zimmerdental.com/im_tswpFBOverView.asp.

(**) Term: **14 Years**

Internet website entitled "The Nano Title Tapered PREVAIL Implant", http://biomet3i.com/English/products/NanoTitle_Tapered_PREVAIL_...

(21) Appl. No.: **29/310,282**

Internet website entitled "Nobel Biocare — beautiful esthetics start below the surface—Nobel B . . .", <http://www1.nobelbiocare.com/en/implant-solutions/home/default.aspx>.

(22) Filed: **Aug. 7, 2008**

(30) **Foreign Application Priority Data**

* cited by examiner

Feb. 7, 2008 (EP) 000874383-0001

Primary Examiner—Charles A Rademaker

(51) **LOC (9) Cl.** **24-03**

(74) *Attorney, Agent, or Firm*—Olson & Cepuritis, Ltd.

(52) **U.S. Cl.** **D24/156**

(58) **Field of Classification Search** D24/155,
D24/156, 180, 176; D8/387, 176; 433/173,
433/176; 606/304, 74, 72

(57) **CLAIM**

See application file for complete search history.

The ornamental design for a dental implant, as shown and described.

(56) **References Cited**

DESCRIPTION

U.S. PATENT DOCUMENTS

FIG. 1 is a side elevation of a dental implant showing my new design;

- D296,362 S * 6/1988 Branemark D24/156
- D390,451 S * 2/1998 Dominguez D8/387
- 5,759,034 A * 6/1998 Daftary 433/173
- 6,095,817 A * 8/2000 Wagner et al. 433/173
- 6,217,333 B1 * 4/2001 Ercoli 433/173
- 6,458,134 B1 * 10/2002 Songer et al. 606/304
- 6,619,958 B2 * 9/2003 Beaty et al. 433/173
- 6,857,874 B2 * 2/2005 Kim 433/173
- D503,803 S * 4/2005 Shalaby et al. D24/156
- 7,207,801 B2 * 4/2007 Vogt et al. 433/173
- D552,977 S * 10/2007 He et al. D8/387

FIG. 2 is a rotated side view of the dental implant of FIG. 1;

FIG. 3 is a rotated side view of the dental implant of FIG. 1;

FIG. 4 is a rotated side view of the dental implant of FIG. 1;

FIG. 5 is a top view of the dental implant of FIG. 1;

FIG. 6 is a bottom view of the dental implant of FIG. 1; and,

FIG. 7 is a perspective view of the dental implant of FIG. 1.

1 Claim, 2 Drawing Sheets

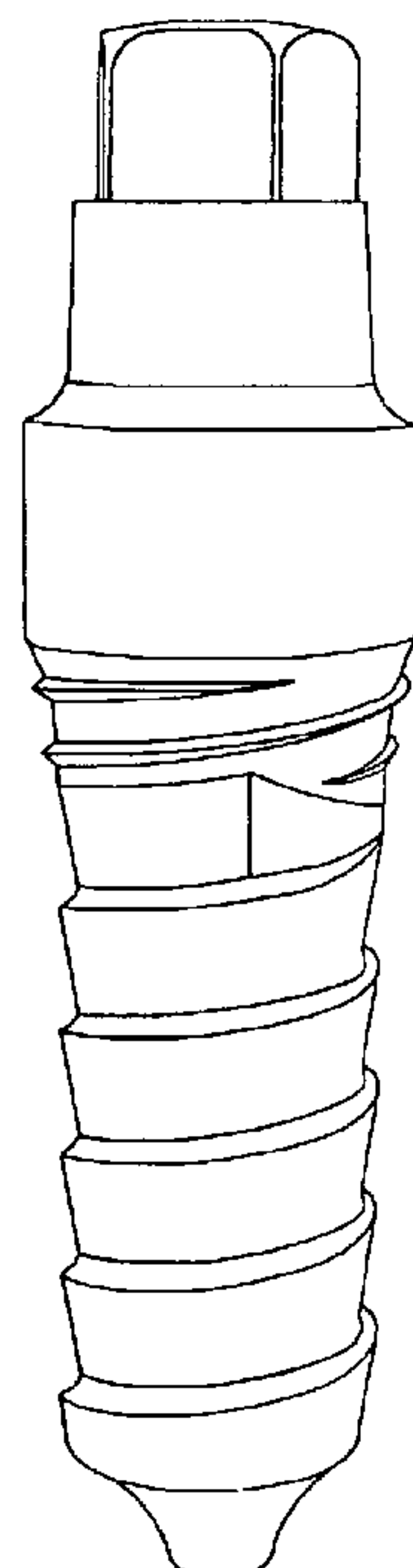

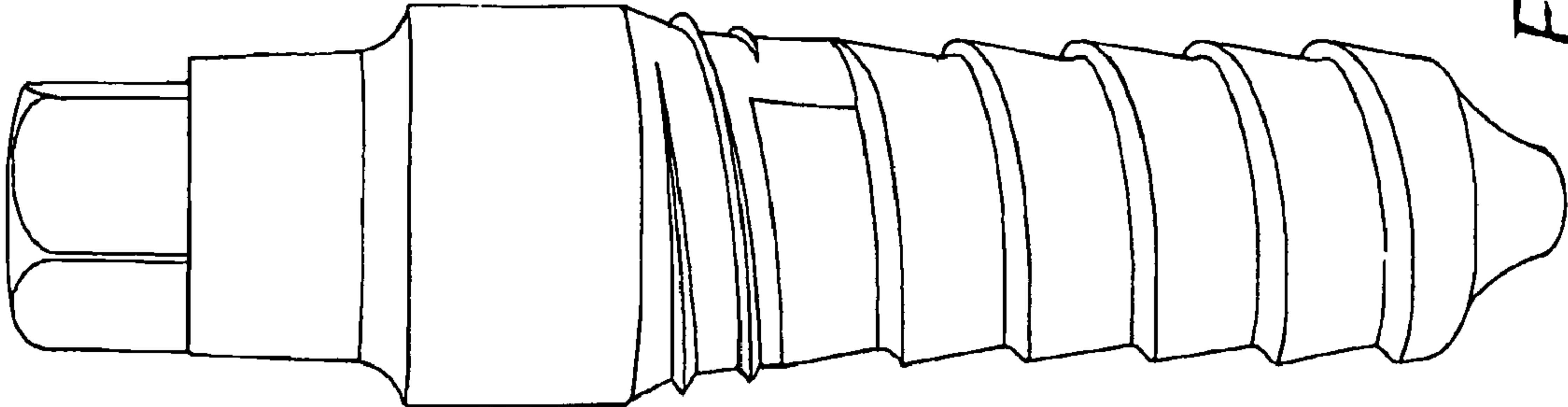

Fig. 3

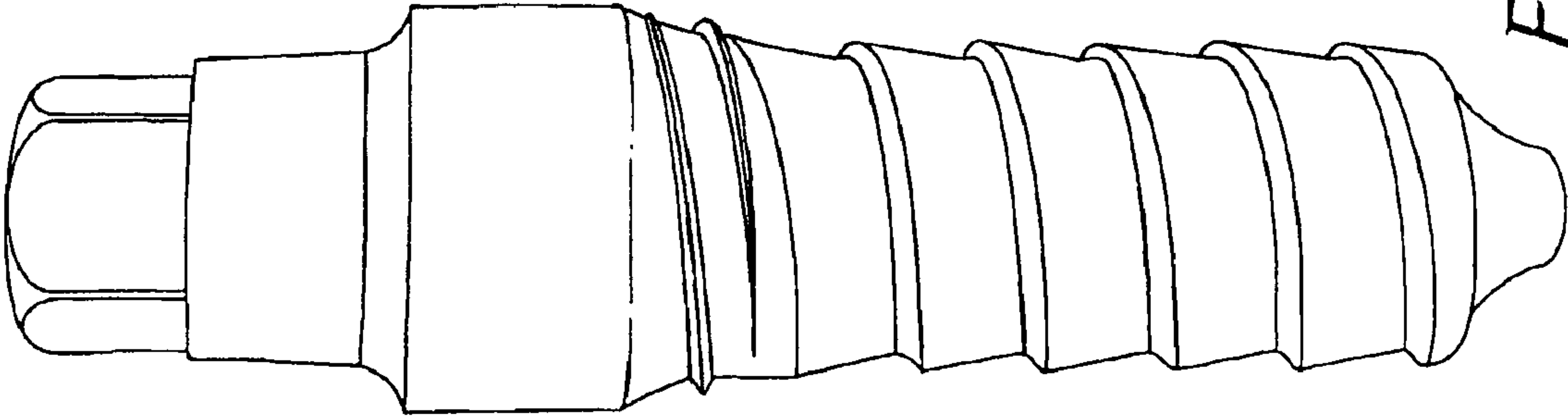

Fig. 2

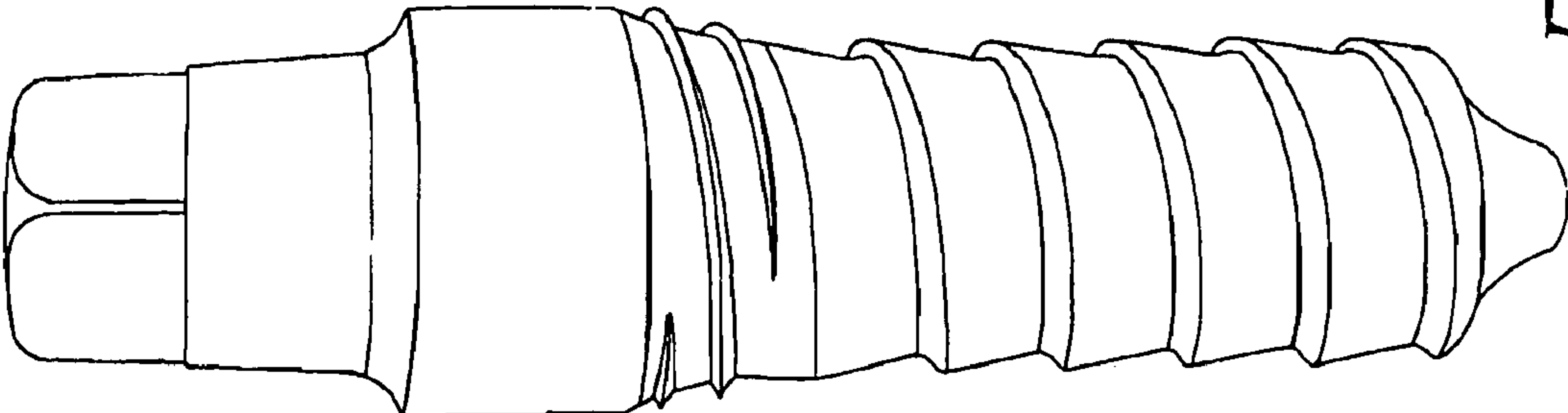

Fig. 1

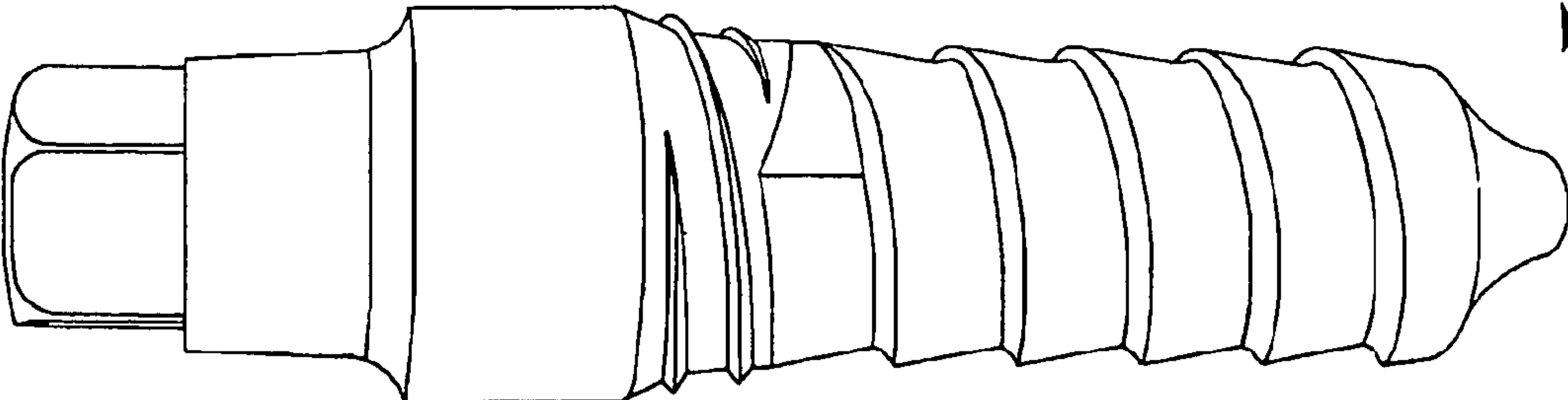

Fig. 4

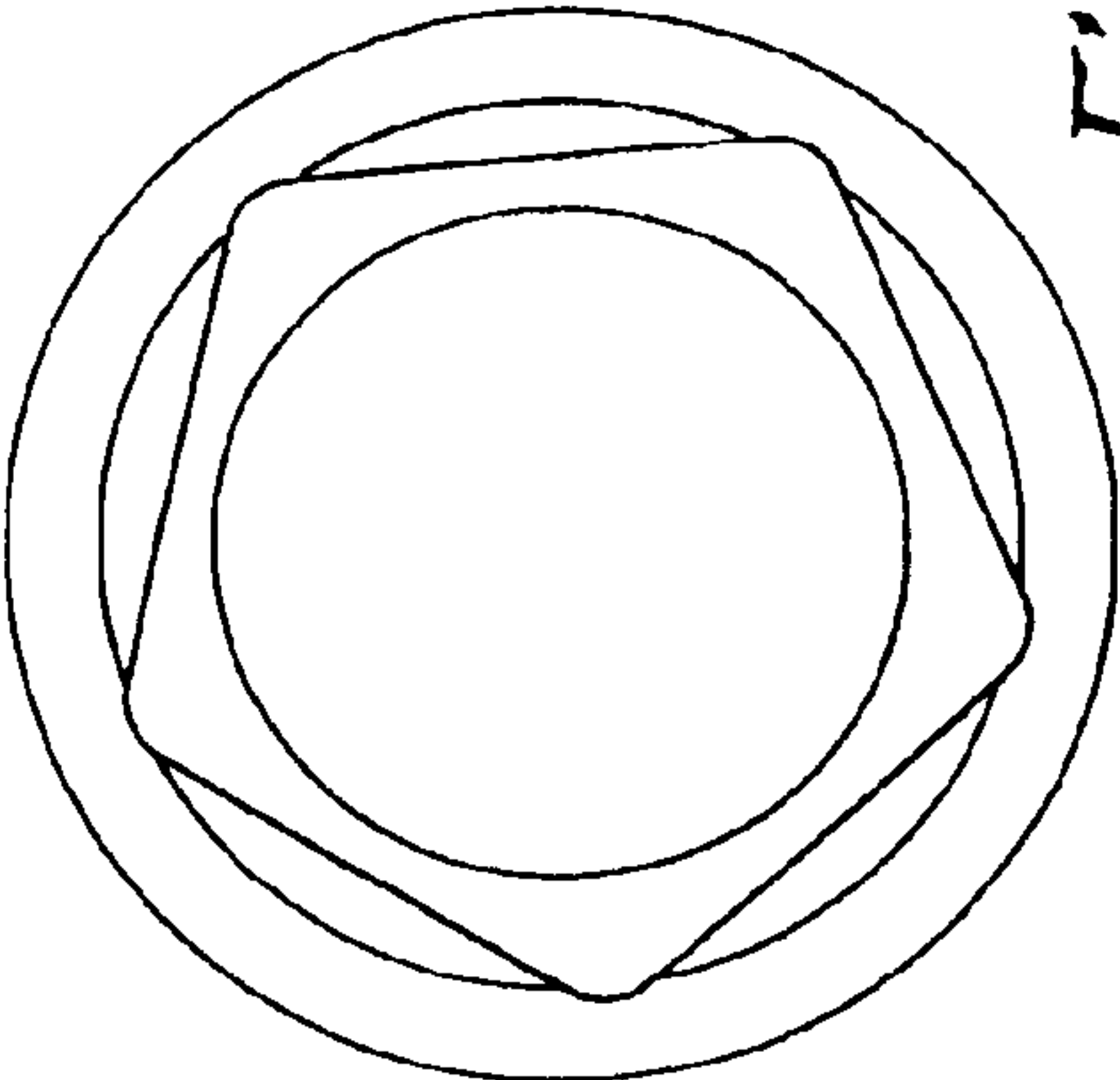

Fig. 5

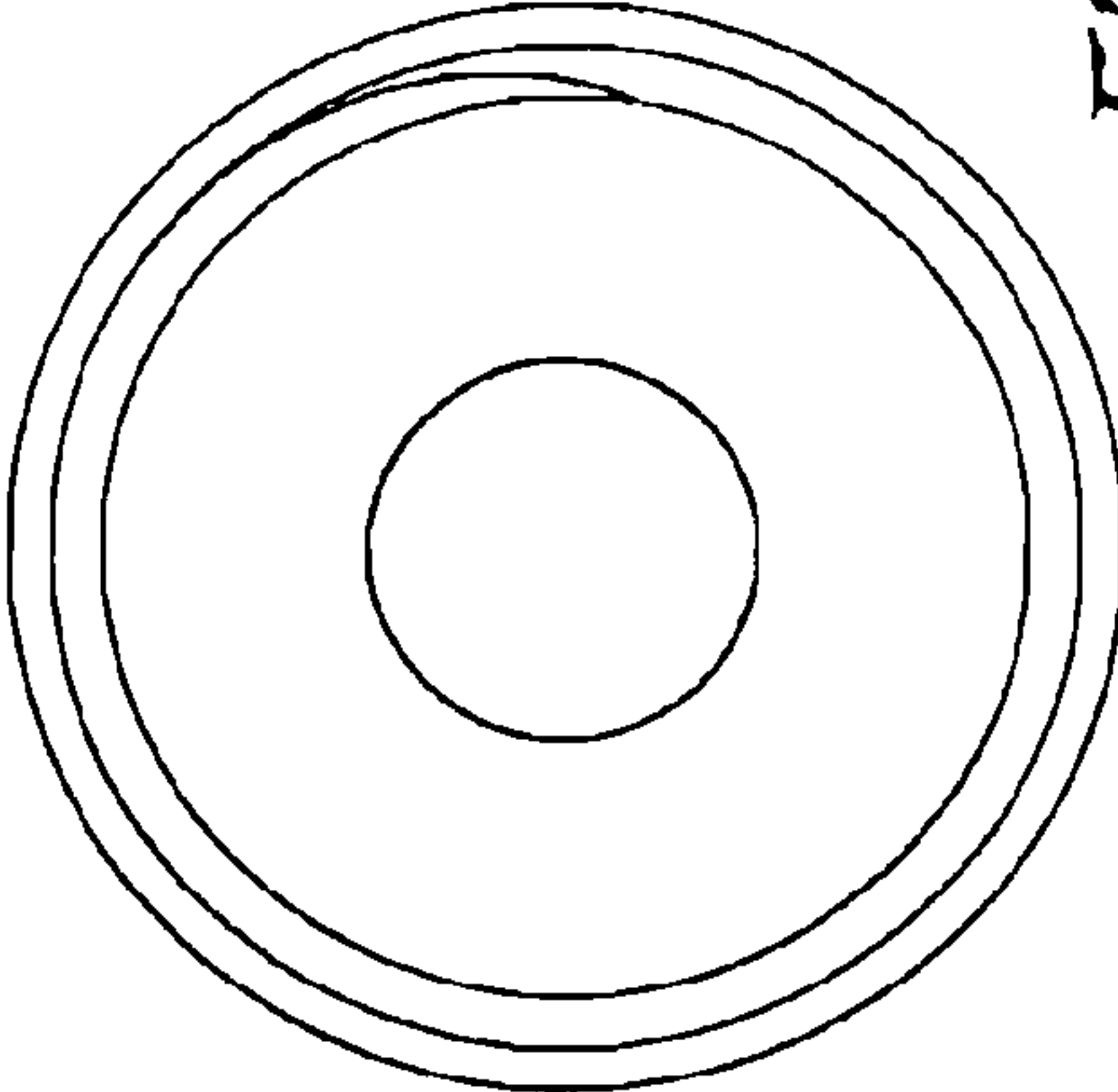

Fig. 6

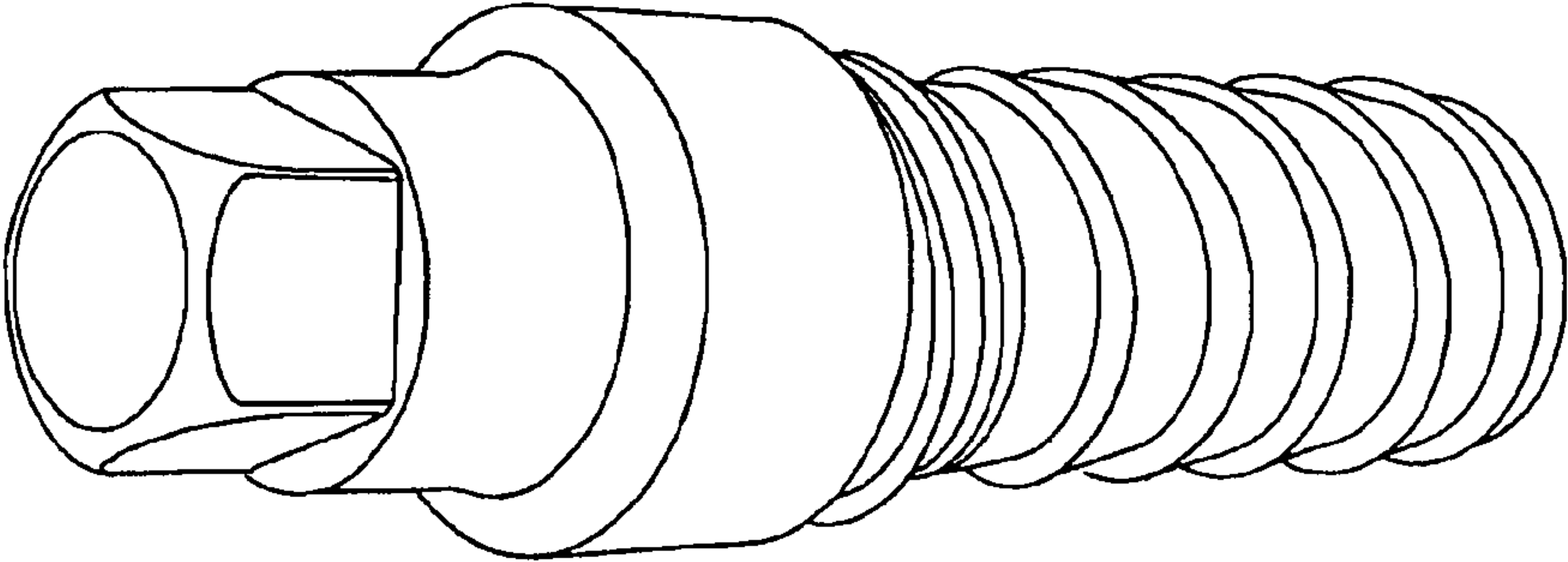

Fig. 7