



US00D601681S

(12) **United States Design Patent**
Cho

(10) **Patent No.:** **US D601,681 S**

(45) **Date of Patent:** **** Oct. 6, 2009**

(54) **ELECTRONIC TOILET SEAT AND LID COMBINATION**

(75) Inventor: **Geum Hwan Cho**, Seoul (KR)

(73) Assignee: **VOVOCORPORATION Co., Ltd.**,
Seoul (KR)

(**) Term: **14 Years**

(21) Appl. No.: **29/319,564**

(22) Filed: **Jun. 11, 2008**

(30) **Foreign Application Priority Data**

Apr. 14, 2008 (KR) 30-2008-0015859

(51) **LOC (9) Cl.** **23-02**

(52) **U.S. Cl.** **D23/295**

(58) **Field of Classification Search** D23/273-274,
D23/303, 309, 311; 4/663-664, 444, 485-486,
4/661, 234, 237, 242.1, 245.1, 902, DIG. 15,
4/217

See application file for complete search history.

(56) **References Cited**

U.S. PATENT DOCUMENTS

D357,308 S * 4/1995 Kaiser D23/311
D382,946 S * 8/1997 Kawamura et al. D23/295
D508,986 S * 8/2005 Peng D23/311

* cited by examiner

Primary Examiner—Robert A Delehanty

(74) *Attorney, Agent, or Firm*—Lowe Hauptman Ham & Berner, LLP

(57) **CLAIM**

The ornamental design for electronic toilet seat and lid combination, as shown.

DESCRIPTION

FIG. 1 is a perspective view of the electronic toilet seat and lid combination according to the invention;

FIG. 2 is a front elevational view thereof;

FIG. 3 is a rear elevational view thereof;

FIG. 4 is a left side elevational view thereof;

FIG. 5 is a right side elevational view thereof;

FIG. 6 is a top plan view thereof;

FIG. 7 is a bottom plan view thereof; and,

FIG. 8 is a perspective view of the electronic toilet seat and lid combination shown in condition of use with a toilet bowl.

The broken lines in FIG. 7 showing of the central rear portions of the seat are for the purpose of illustrating portions of the electronic toilet seat and lid combination and form no part of the claimed design.

The broken lines in FIG. 8 showing of the toilet bowl are for the purpose of illustrating portions of the electronic toilet seat and lid combination and form no part of the claimed design.

1 Claim, 6 Drawing Sheets

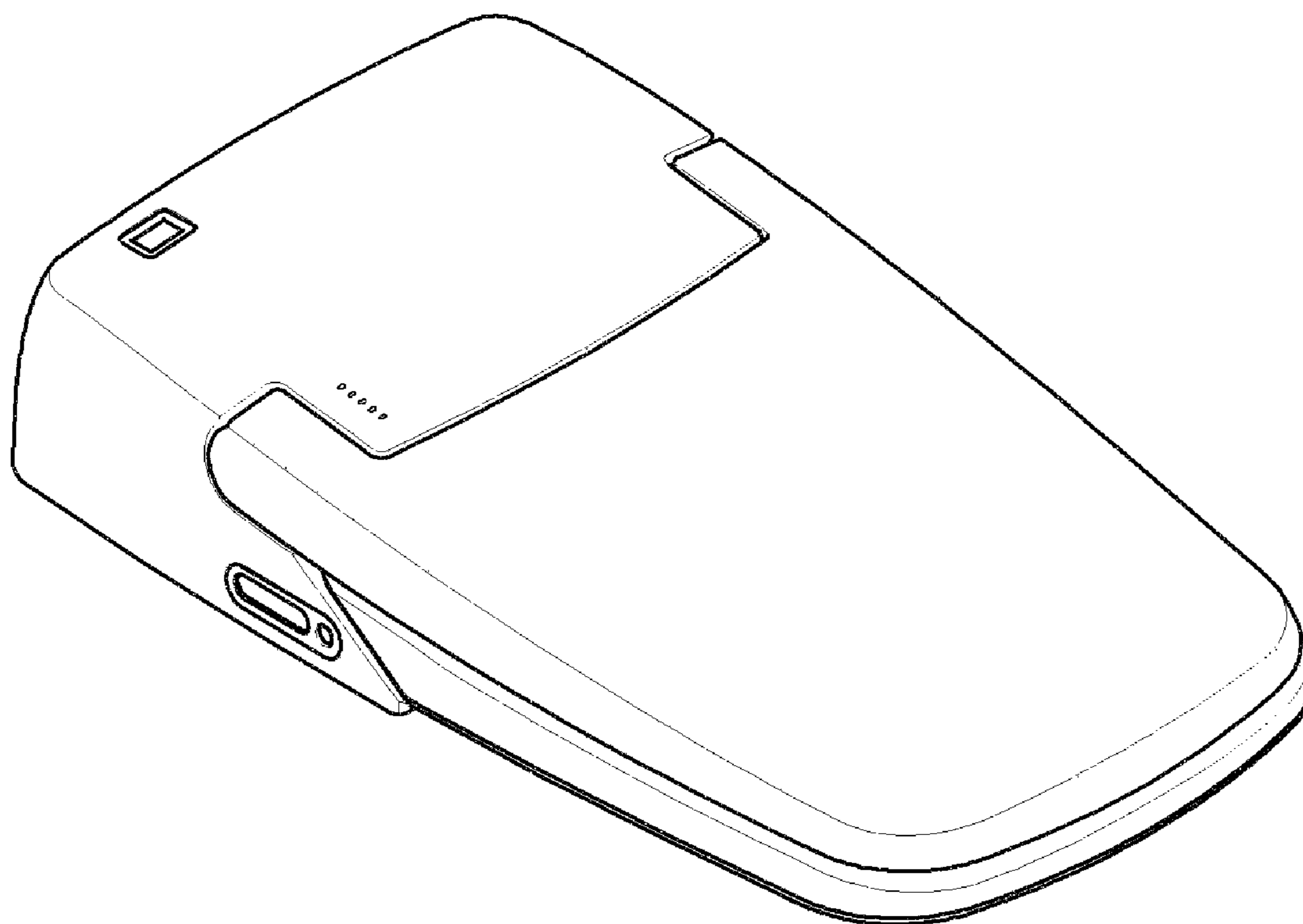

FIG. 1

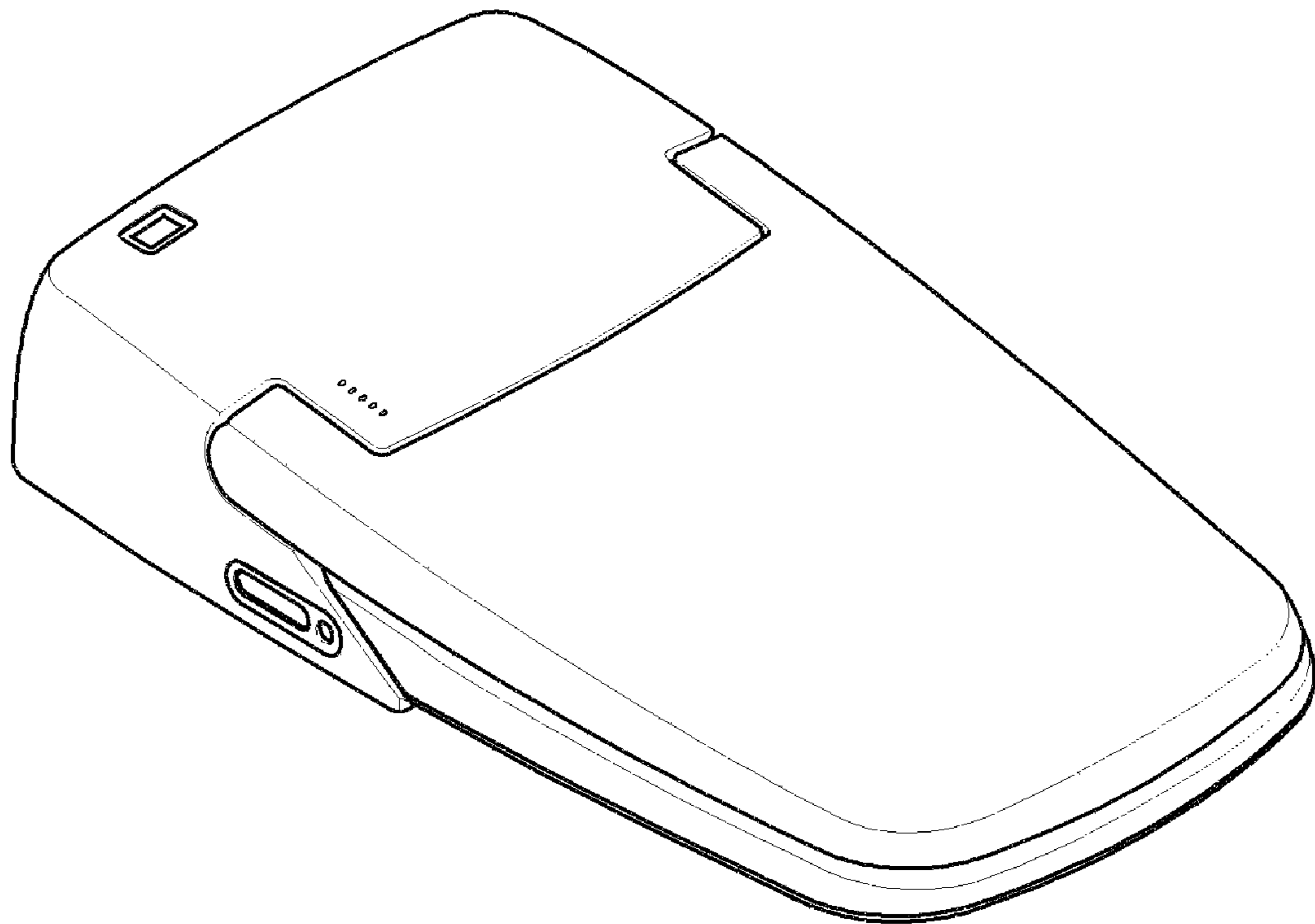

FIG. 2

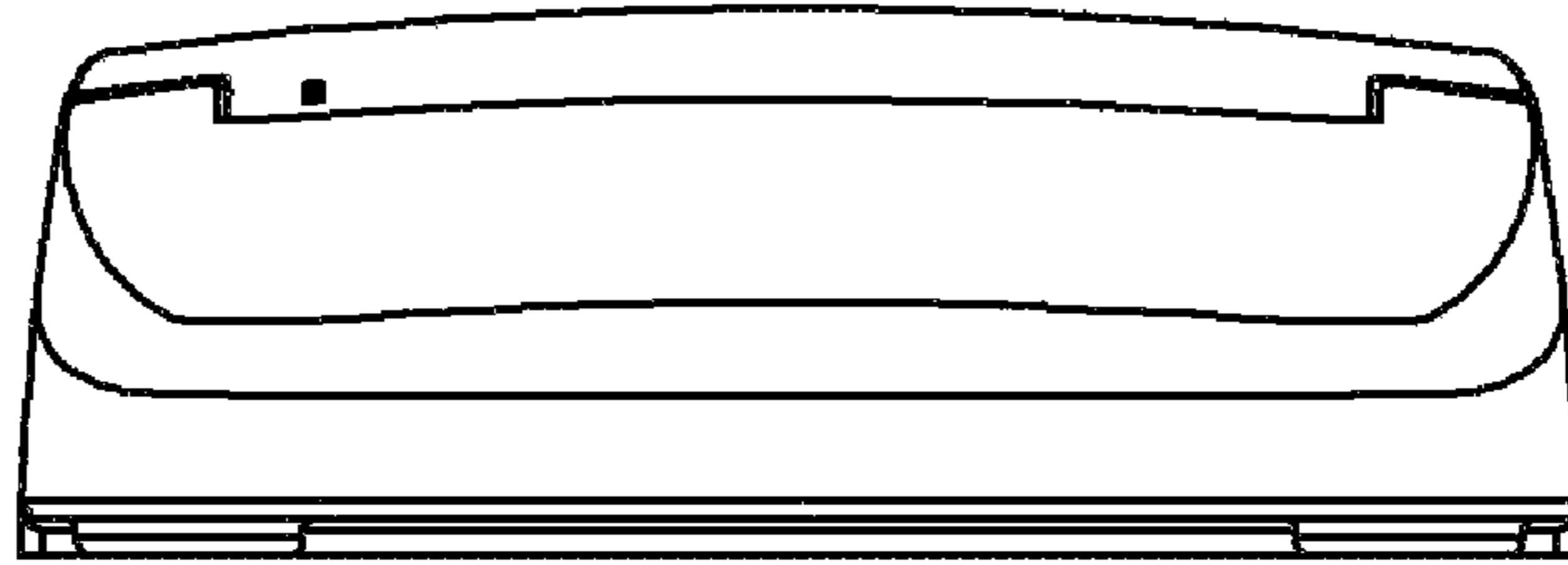

FIG. 3



FIG. 4

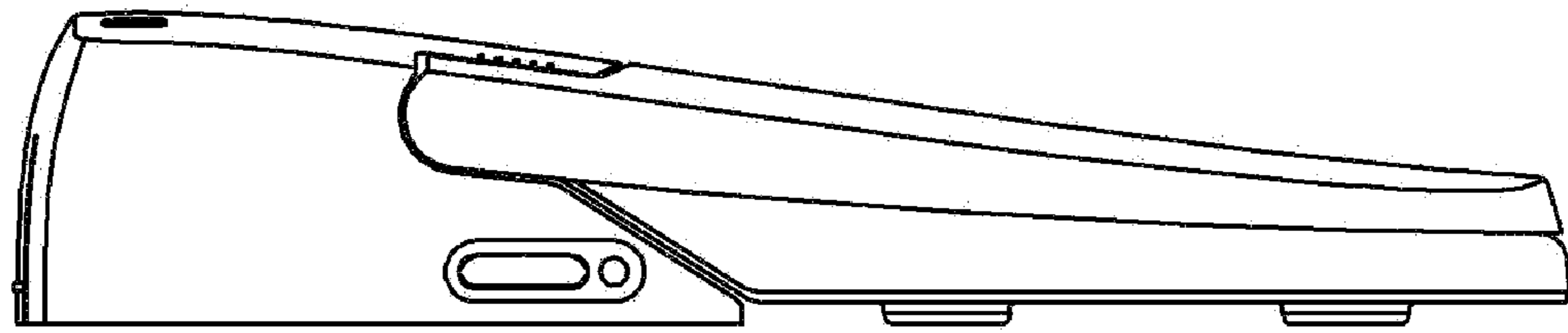

FIG. 5

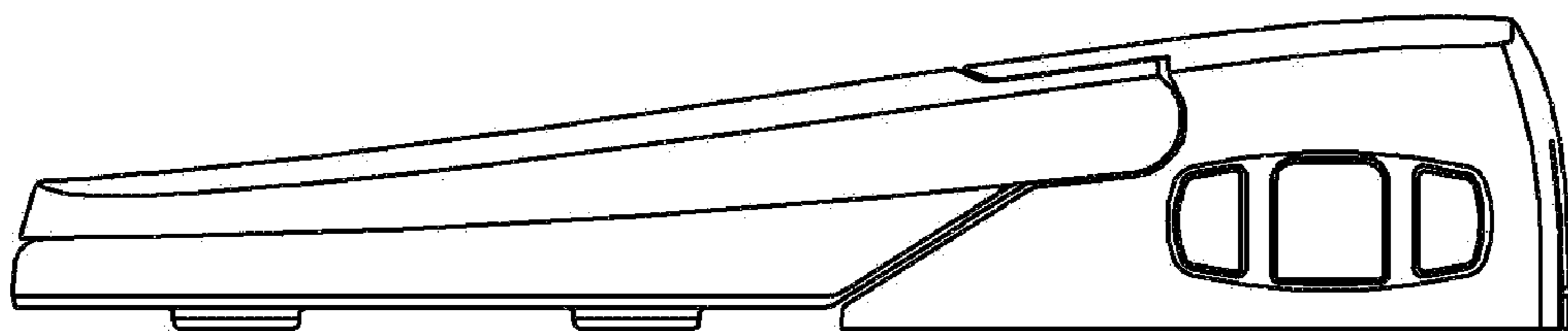

FIG. 6

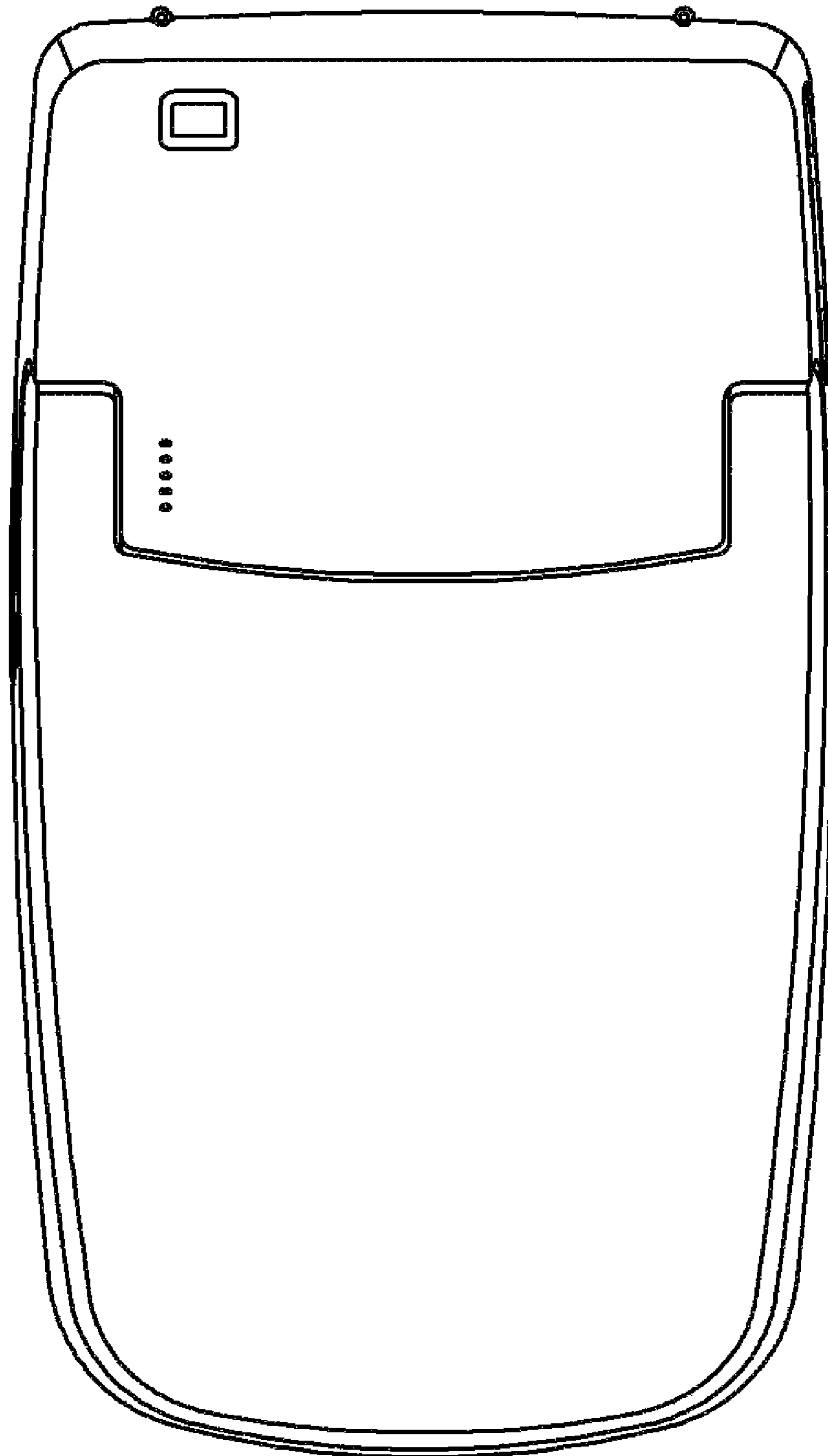

FIG. 7

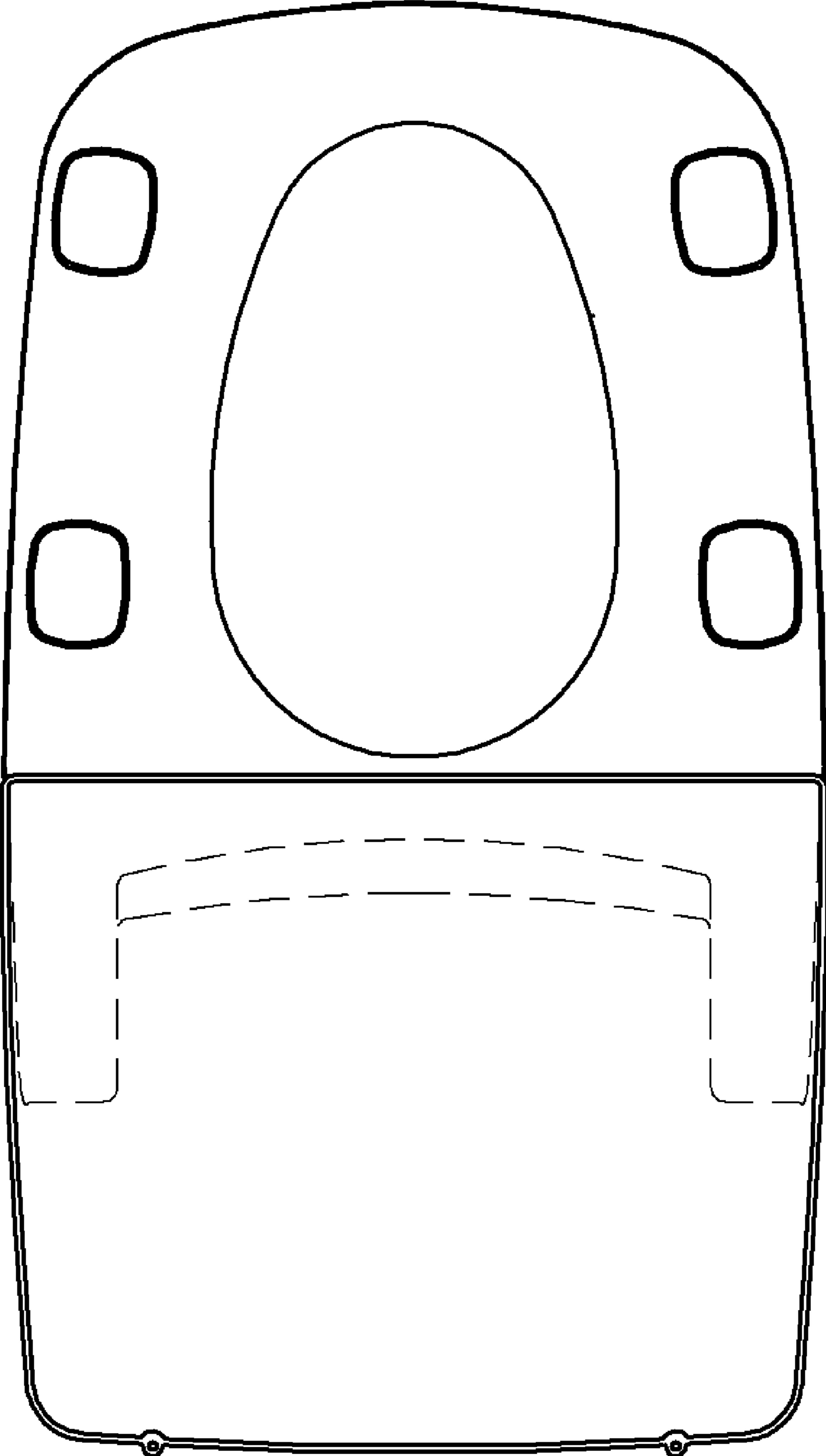

FIG. 8

