



US00D601671S

(12) **United States Design Patent**  
**Johnson**

(10) **Patent No.:** **US D601,671 S**  
(45) **Date of Patent:** **\*\* Oct. 6, 2009**

(54) **SLIDER VALVE FITMENT COLLAR**

(75) Inventor: **James Johnson**, Delaware, OH (US)

(73) Assignee: **Liqu-Box Corporation**, Worthington, OH (US)

(\*\*) Term: **14 Years**

(21) Appl. No.: **29/329,920**

(22) Filed: **Dec. 23, 2008**

D501,673 S *	2/2005	Bressler et al.	.....	D23/262
D508,111 S *	8/2005	Karasawa	.....	D23/262
6,953,070 B1	10/2005	Labinski et al.		
D511,203 S *	11/2005	Bressler et al.	.....	D23/262
7,487,951 B2 *	2/2009	Johnson	.....	251/149.1
2002/0139423 A1 *	10/2002	Roethel	.....	137/614.03
2004/0256424 A1 *	12/2004	Johnson	.....	222/518
2008/0053568 A1 *	3/2008	Johnson	.....	141/383

FOREIGN PATENT DOCUMENTS

CA	2371239	12/2000
CA	2554832	8/2005
WO	WO2004/085283	7/2004

\* cited by examiner

*Primary Examiner*—T. Chase Nelson  
*Assistant Examiner*—Eric L Goodman

**Related U.S. Application Data**

(63) Continuation of application No. 11/895,843, filed on Aug. 28, 2007.

(51) **LOC (9) Cl.** ..... **23-01**

(52) **U.S. Cl.** ..... **D23/262**

(58) **Field of Classification Search** ..... D23/259–268;  
137/614.03; 141/346–351, 383–385; 251/149.6,  
251/149.1

See application file for complete search history.

(57) **CLAIM**

The ornamental design for the slider valve fitment collar, substantially as shown and described.

**DESCRIPTION**

FIG. 1 is a top perspective view of a slider valve fitment collar. FIG. 2 is a bottom perspective view of a slider valve fitment collar.

FIG. 3 is a top view of a slider valve fitment collar.

FIG. 4 is a front view of a slider valve fitment collar.

FIG. 5 is a bottom view of a slider valve fitment collar; and,

FIG. 6 is a second view of the slider valve fitment collar, including environmental features.

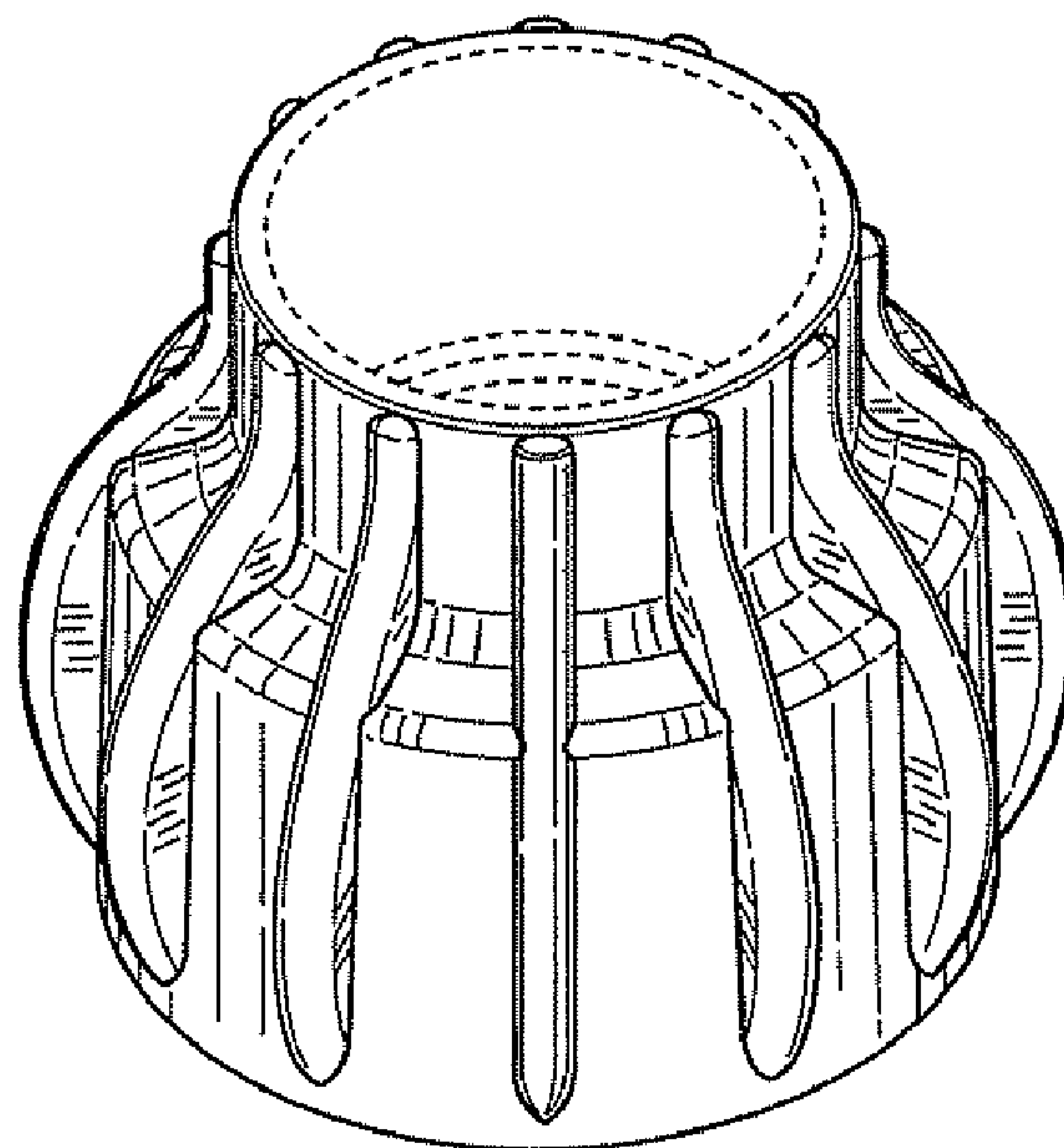
The broken line showing is included for the purpose of illustrating portions of the article and environmental structure that forms no part of the claimed design.

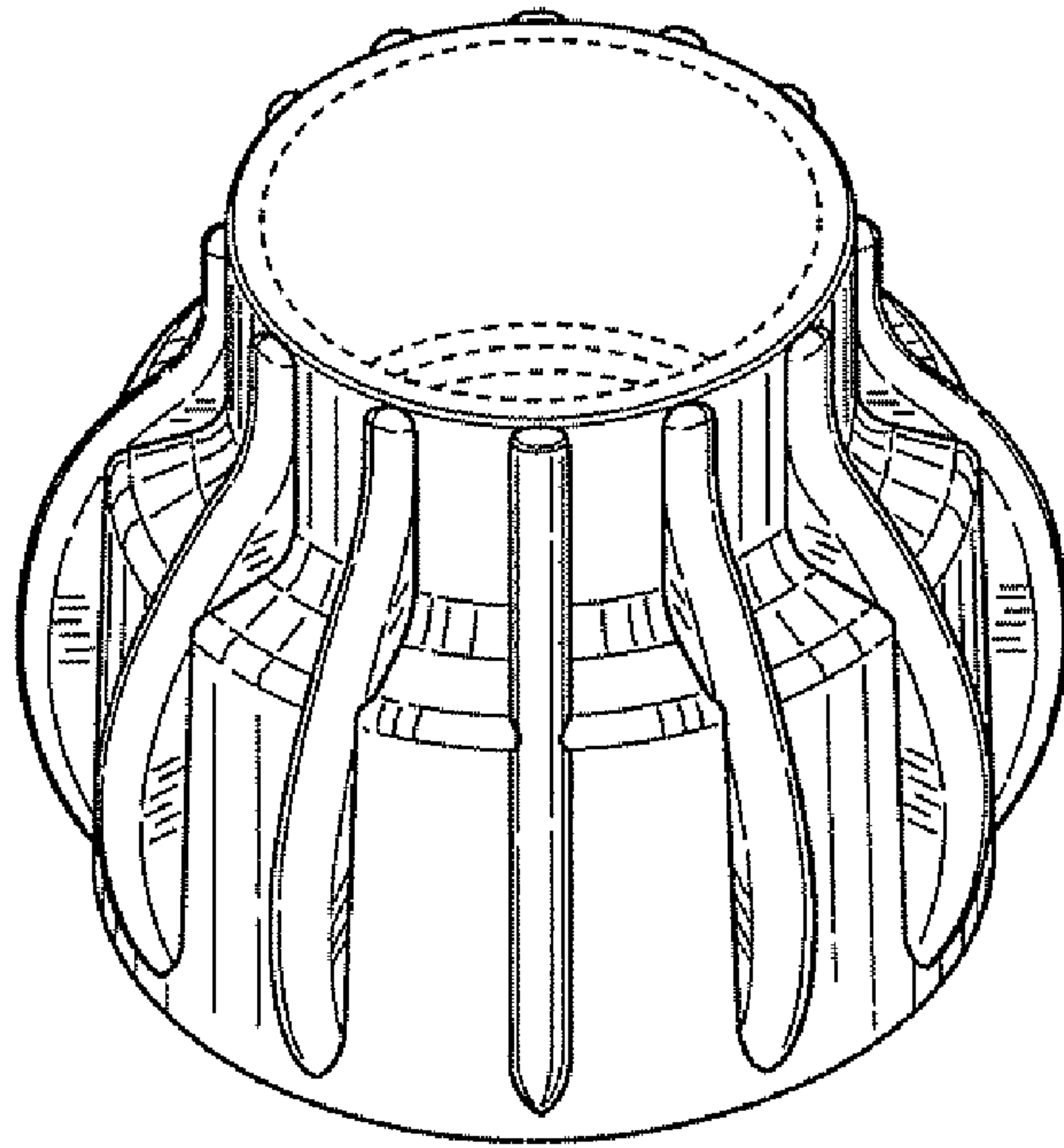
(56) **References Cited**

U.S. PATENT DOCUMENTS

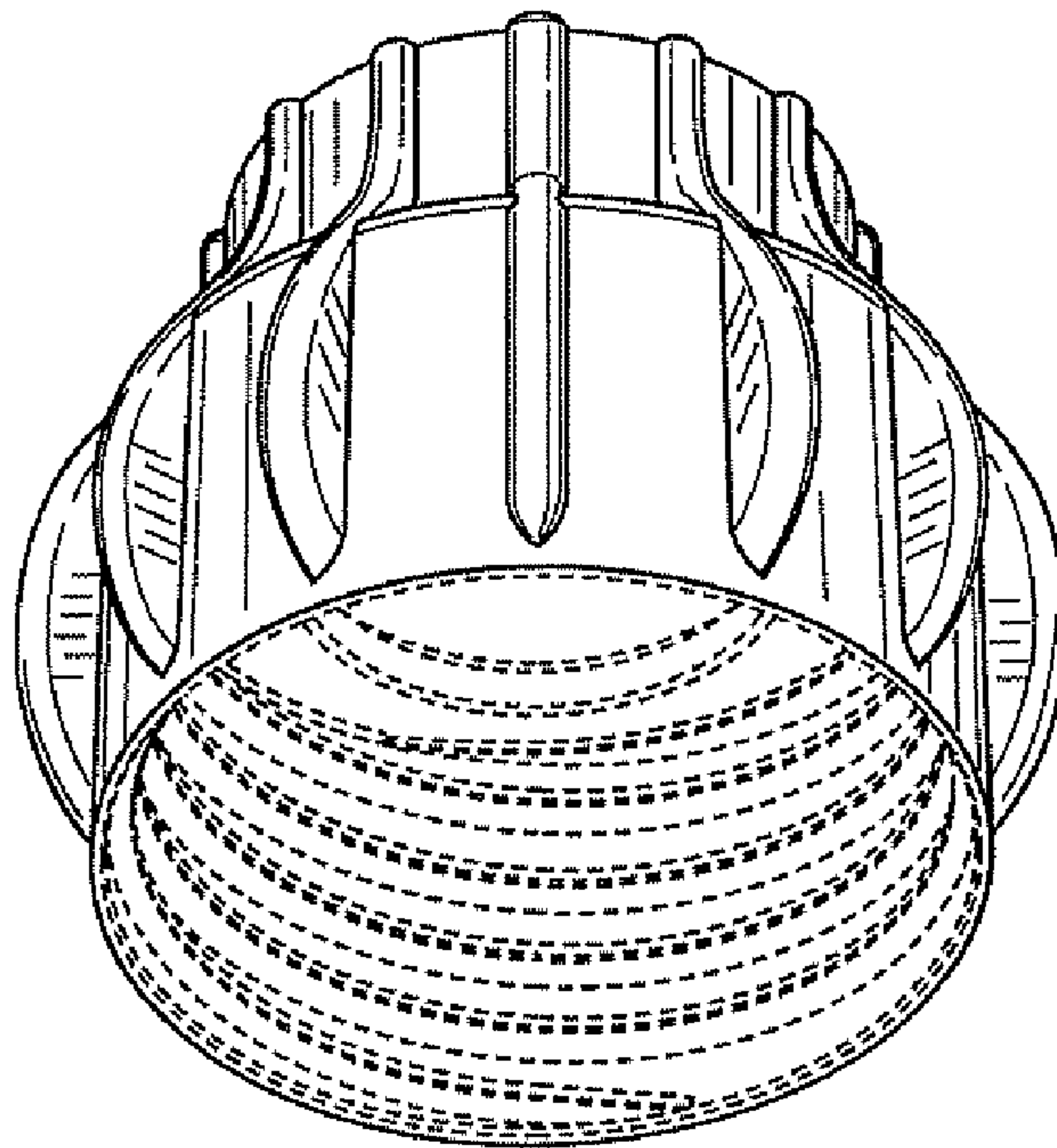
4,421,146 A	12/1983	Bond et al.	
4,445,551 A	5/1984	Bond et al.	
5,031,662 A	7/1991	Roethel	
5,095,962 A	3/1992	Lloyd-Davies et al.	
5,680,970 A	10/1997	Smith et al.	
5,697,410 A	12/1997	Rutter et al.	
5,901,761 A	5/1999	Rutter et al.	
5,983,964 A	11/1999	Zielinski et al.	
D421,098 S *	2/2000	Wrigley et al.	..... D23/249
6,347,785 B1	2/2002	Copp et al.	
6,648,016 B2 *	11/2003	Farrenkopf et al.	..... 137/588
6,779,556 B2	8/2004	Roethel	

**1 Claim, 3 Drawing Sheets**

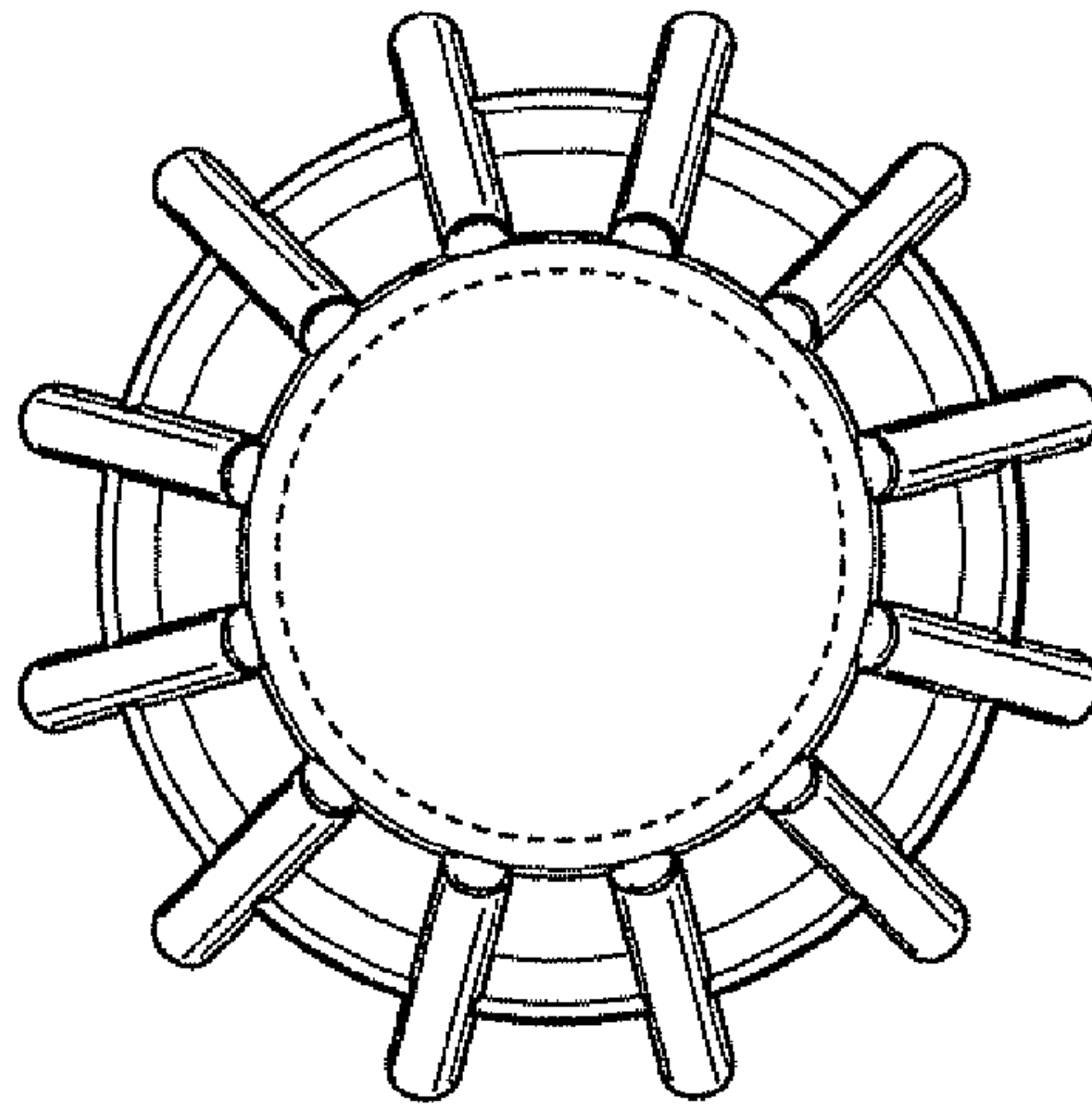




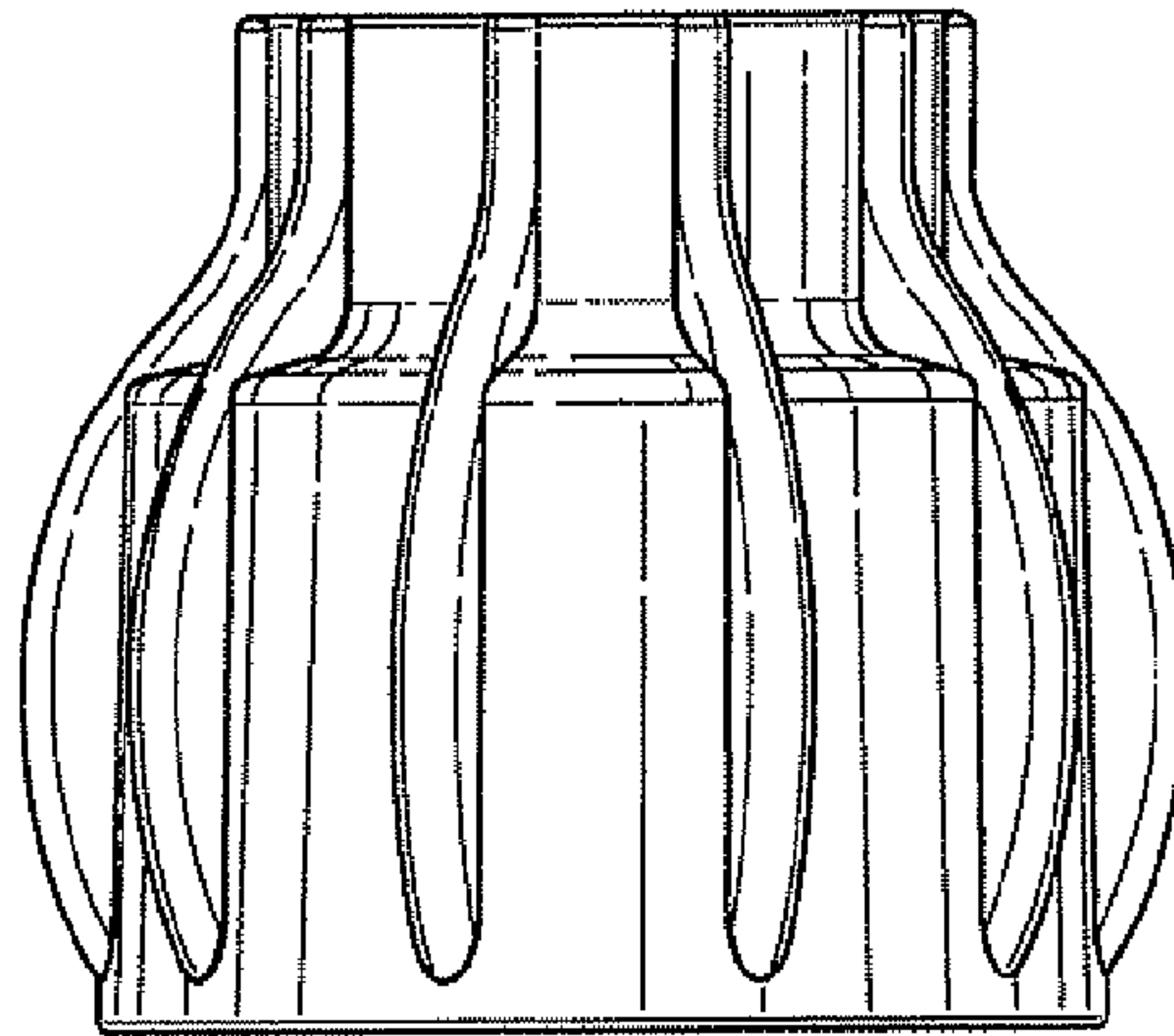
**FIG. 1**



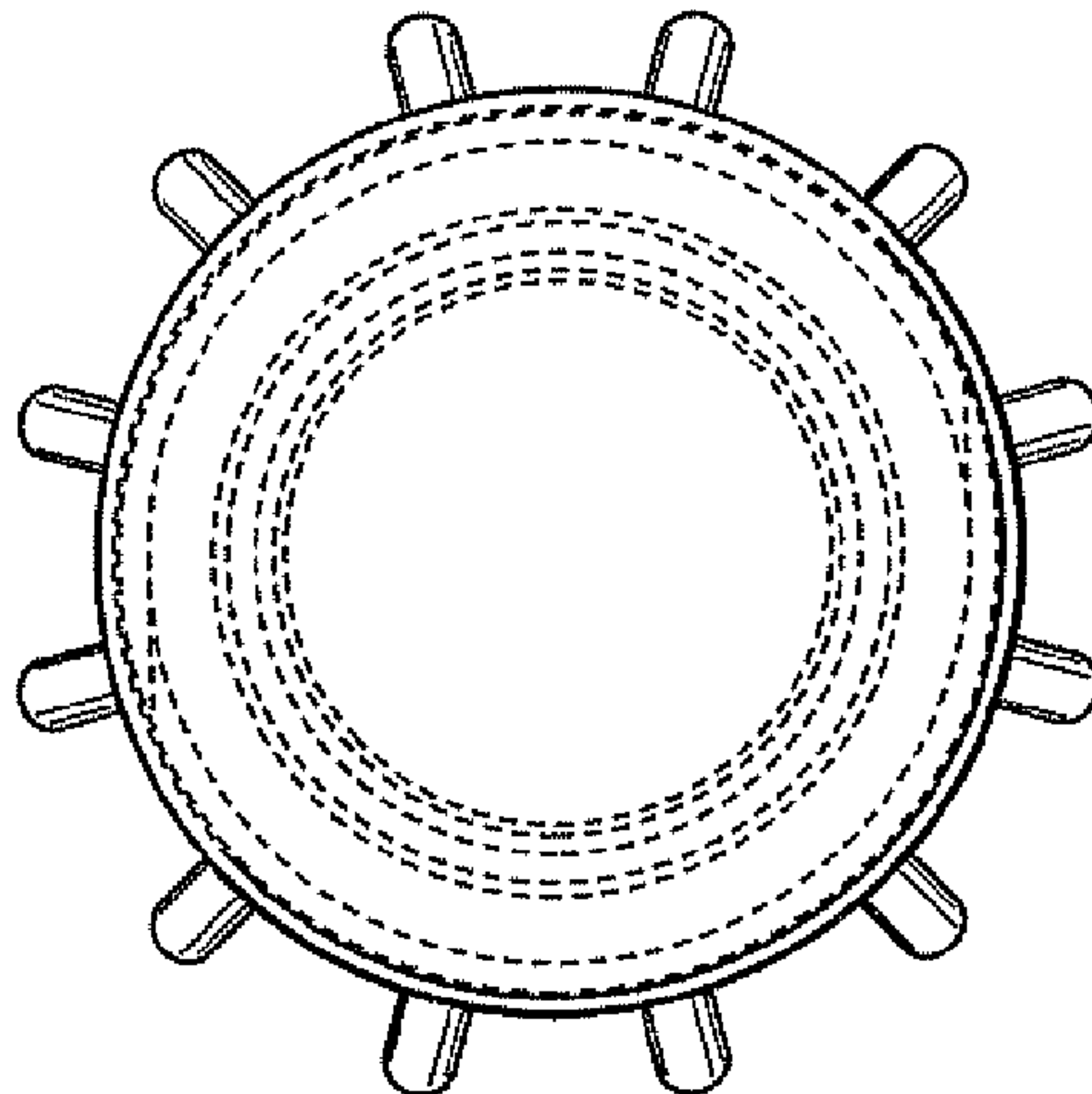
**FIG. 2**



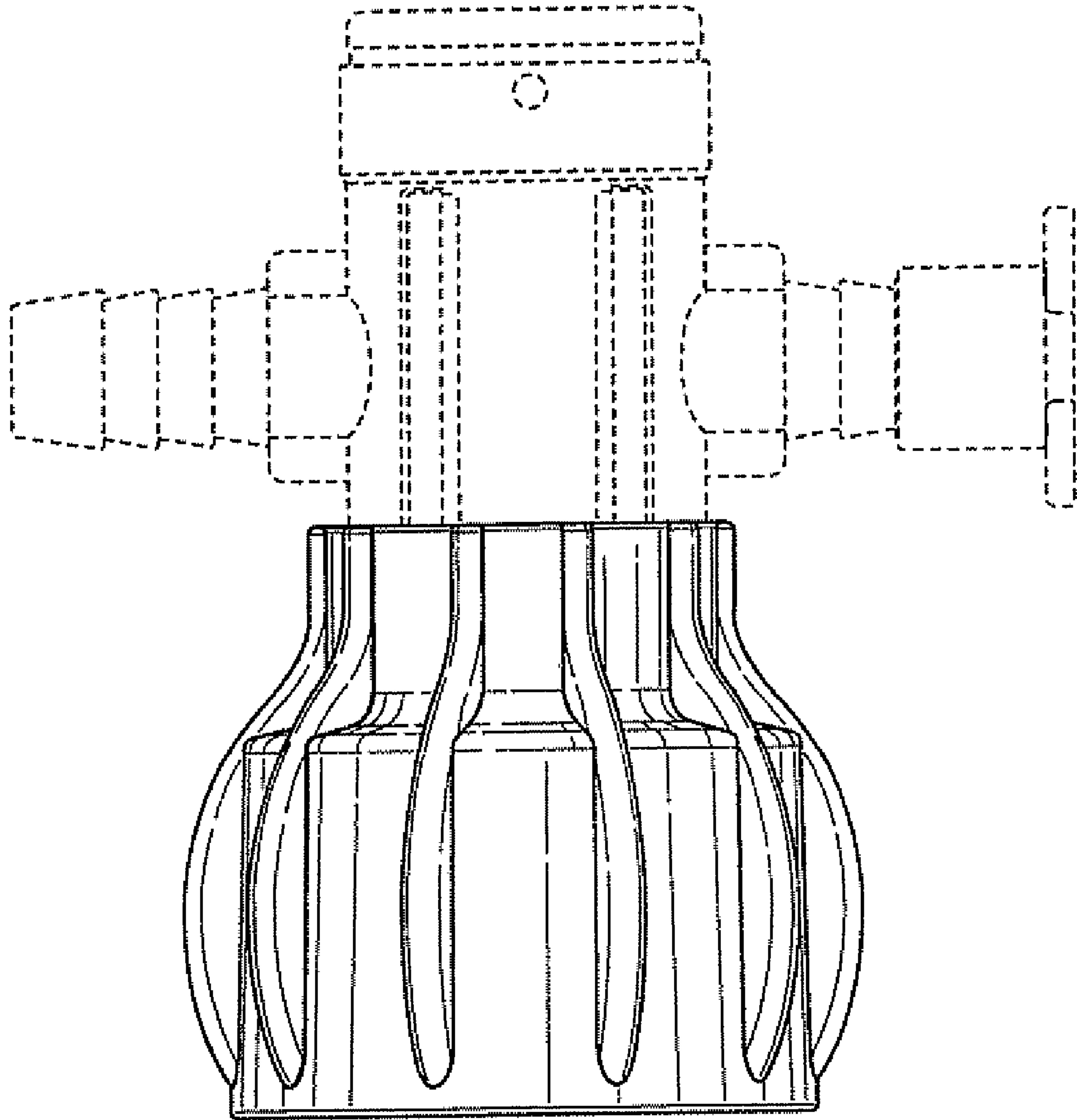
**FIG. 3**



**FIG. 4**



**FIG. 5**



**FIG. 6**