



US00D601583S

(12) **United States Design Patent**
Andre et al.

(10) **Patent No.:** **US D601,583 S**
(45) **Date of Patent:** **** Oct. 6, 2009**

(54) **MEDIA DEVICE**

(75) Inventors: **Bartley K. Andre**, Menlo Park, CA (US); **Daniel J. Coster**, San Francisco, CA (US); **Daniele De Iuliis**, San Francisco, CA (US); **Richard P. Howarth**, San Francisco, CA (US); **Jonathan P. Ive**, San Francisco, CA (US); **Duncan Robert Kerr**, San Francisco, CA (US); **Shin Nishibori**, San Francisco, CA (US); **Matthew Dean Rohrbach**, San Francisco, CA (US); **Douglas B. Salzger**, Menlo Park, CA (US); **Calvin O. Seid**, Palo Alto, CA (US); **Christopher J. Stringer**, Portola Valley, CA (US); **Eugene Anthony Whang**, San Francisco, CA (US); **Rico Zorkendorfer**, San Francisco, CA (US); **Steve Jobs**, Palo Alto, CA (US)

5,914,707 A * 6/1999 Kono 345/173
D426,831 S 6/2000 Hu
D435,845 S 1/2001 Piersol
6,254,477 B1 * 7/2001 Sasaki et al. 463/1
D461,187 S 8/2002 Andre et al.
6,595,860 B1 * 7/2003 Yamamoto et al. 463/43
D494,579 S 8/2004 Chuang et al.

(Continued)

FOREIGN PATENT DOCUMENTS

JP 1241896 6/2005
JP D1241895 6/2005

OTHER PUBLICATIONS

http://www.amazon.com/gp/product/images/B000CDR8PU/ref=dp_otherviews_3?ie=UTF8&s=electronics&simg=3, Apr. 1, 2008 □□ first available Apr. 2, 2004.*

(Continued)

Primary Examiner—Prabhakar Deshmukh

(74) *Attorney, Agent, or Firm*—SAIDMAN DesignLaw Group

(73) Assignee: **Apple Inc.**, Cupertino, CA (US)

(**) Term: **14 Years**

(21) Appl. No.: **29/265,955**

(22) Filed: **Sep. 11, 2006**

(51) **LOC (9) Cl.** **14-03**

(52) **U.S. Cl.** **D14/496**

(58) **Field of Classification Search** D14/496,
D14/401, 435, 474, 483, 217, 137, 138, 160,
D14/168; 345/156, 169, 173–179, 905; 715/727–729,
715/864; 710/1, 5, 8; 713/1, 600; 455/11,
455/1.7, 73, 344–347, 93, 95; 370/342–344;
369/1, 2, 6, 12; 463/43–47; 273/148 B

See application file for complete search history.

(56) **References Cited**

U.S. PATENT DOCUMENTS

D258,577 S 3/1981 Bottner
D347,212 S 5/1994 Riley
D373,117 S 8/1996 Barthelemy et al.

(57) **CLAIM**

We claim the ornamental design for an media device, substantially as shown and described.

DESCRIPTION

FIG. 1 is a top perspective view of a media device showing our new design;

FIG. 2 is a top view thereof;

FIG. 3 is a bottom view thereof;

FIG. 4 is a front view thereof;

FIG. 5 is a rear view thereof;

FIG. 6 is a right side view thereof; and,

FIG. 7 is a left side view thereof.

The broken lines are environmental only and form no part of the claimed design.

1 Claim, 3 Drawing Sheets

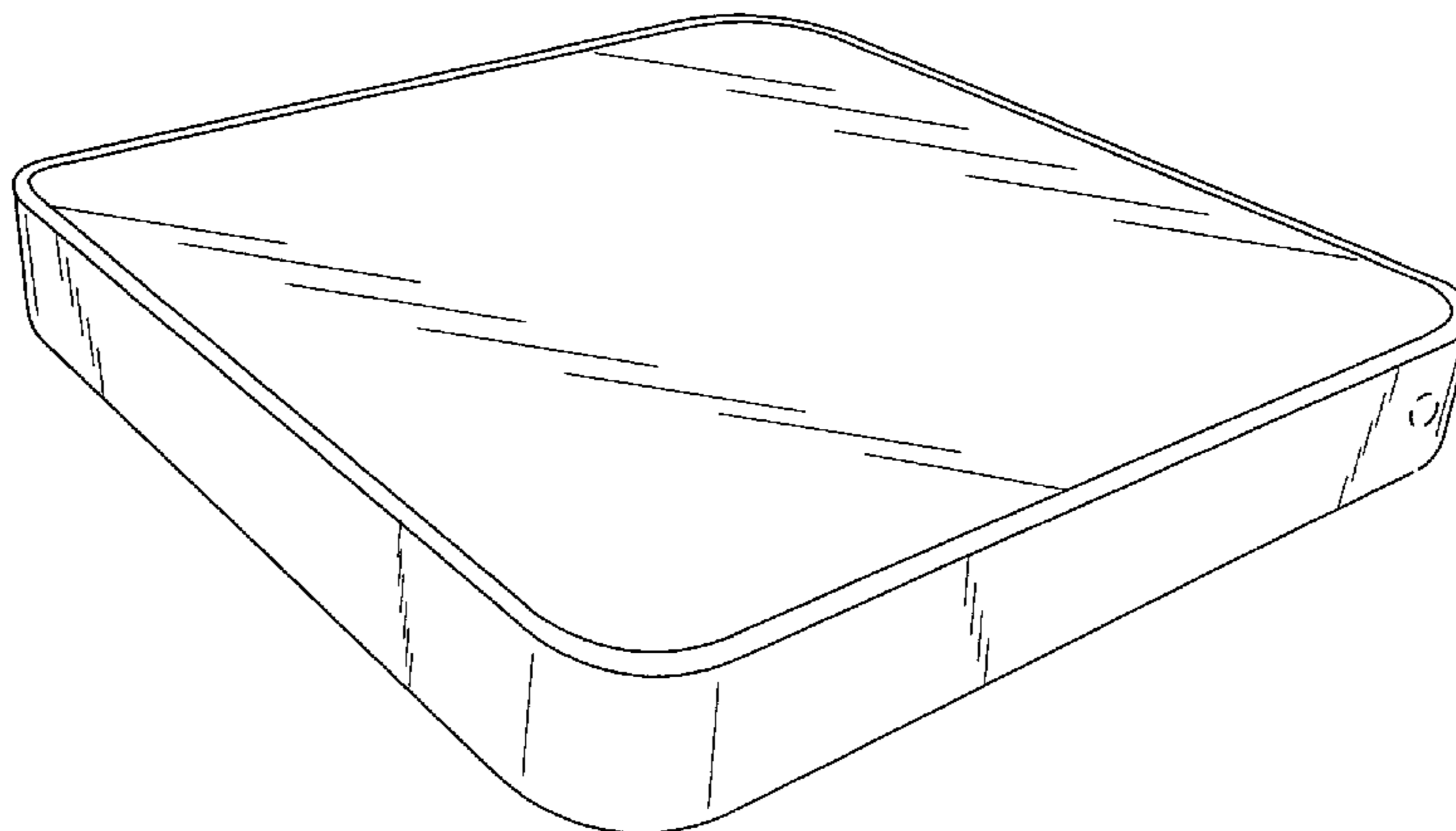

US D601,583 S

Page 2

U.S. PATENT DOCUMENTS

6,795,318 B2 * 9/2004 Haas et al. 361/729
D497,449 S * 10/2004 Dolan D26/110
6,933,928 B1 * 8/2005 Lilienthal 345/173
D513,617 S * 1/2006 Tierney D14/496
D520,519 S * 5/2006 Chin et al.
D522,531 S * 6/2006 Solomon et al. D14/496
D526,648 S 8/2006 Andre et al.
D533,177 S 12/2006 Andre et al.
7,184,802 B2 * 2/2007 Chadha 455/575.1
D537,817 S 3/2007 Andre et al.
D542,288 S 5/2007 Andre et al.
D544,497 S * 6/2007 Kindle et al. D14/496
D558,790 S * 1/2008 Yu et al. D14/496

OTHER PUBLICATIONS

NexStar, GX, www.vantecuca.com, available at least as early as Mar. 2006.

“Eyegonomic Eyebox,” downloaded on Feb. 7, 2005 <http://www.eyegonomic.com/page=205>.

Notice of Reason(s) for Refusal, re: corresponding Japanese Design Application No. 2005-017533, Oct. 14, 2005.

U.S. Appl. No. 29/266,005 entitled “Media Device” filed Sep. 11, 2006.

Green House, Mac Mini, www.green-house.co.jp, Nov. 14, 2005.

Photographs of VANTEC NexStar GX, available at least as early as Mar. 2006.

U.S. Appl. No. 29/281,459 entitled “Electronic Device” filed Jun. 22, 2007.

Office action dated Apr. 22, 2008 in U.S. Appl. No. 29/266,005 entitled “Media Device”.

Office action dated Nov. 25, 2008 in U.S. Appl. No. 29/266,005 entitled “Media Device”.

* cited by examiner

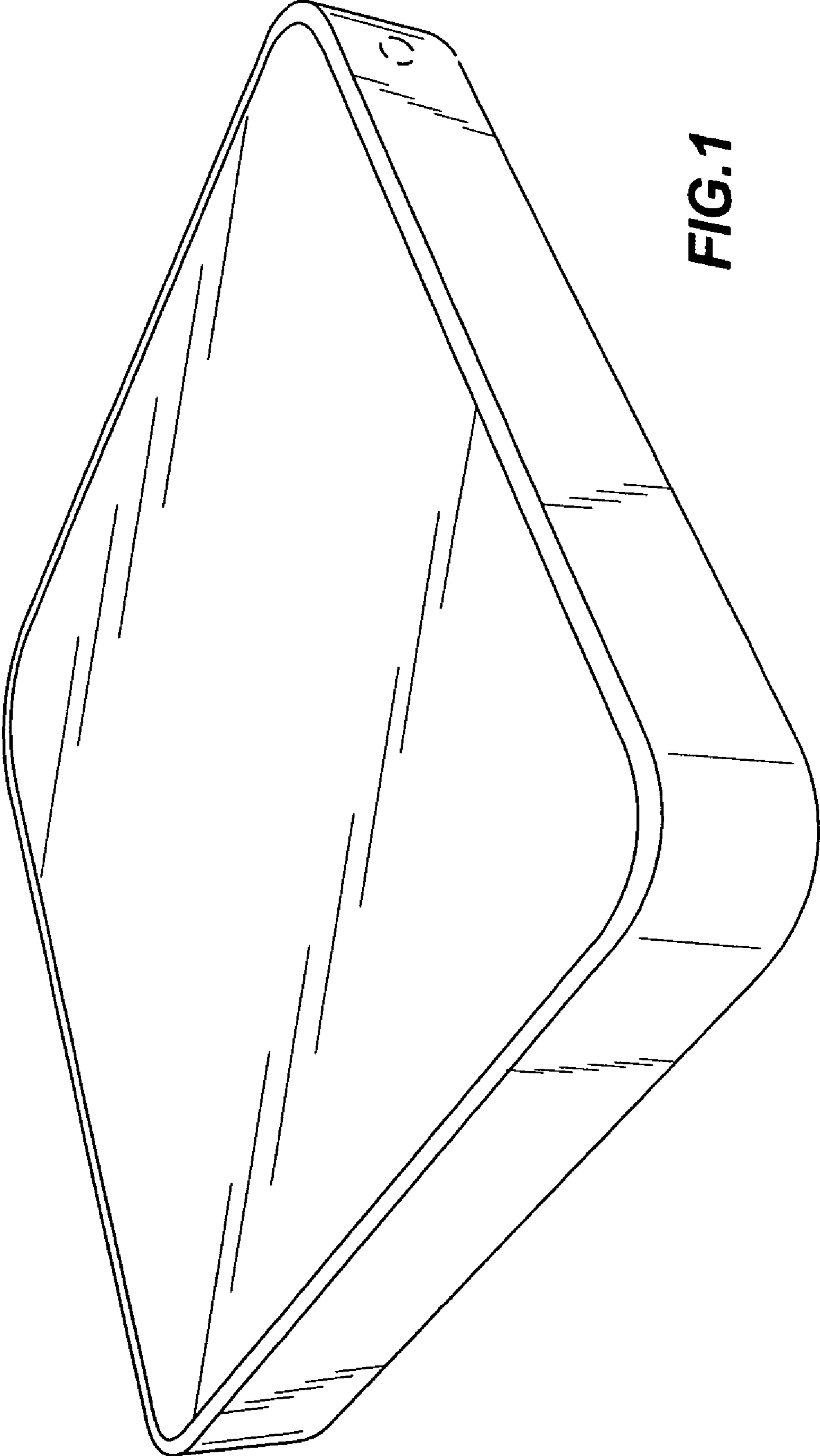

FIG. 1

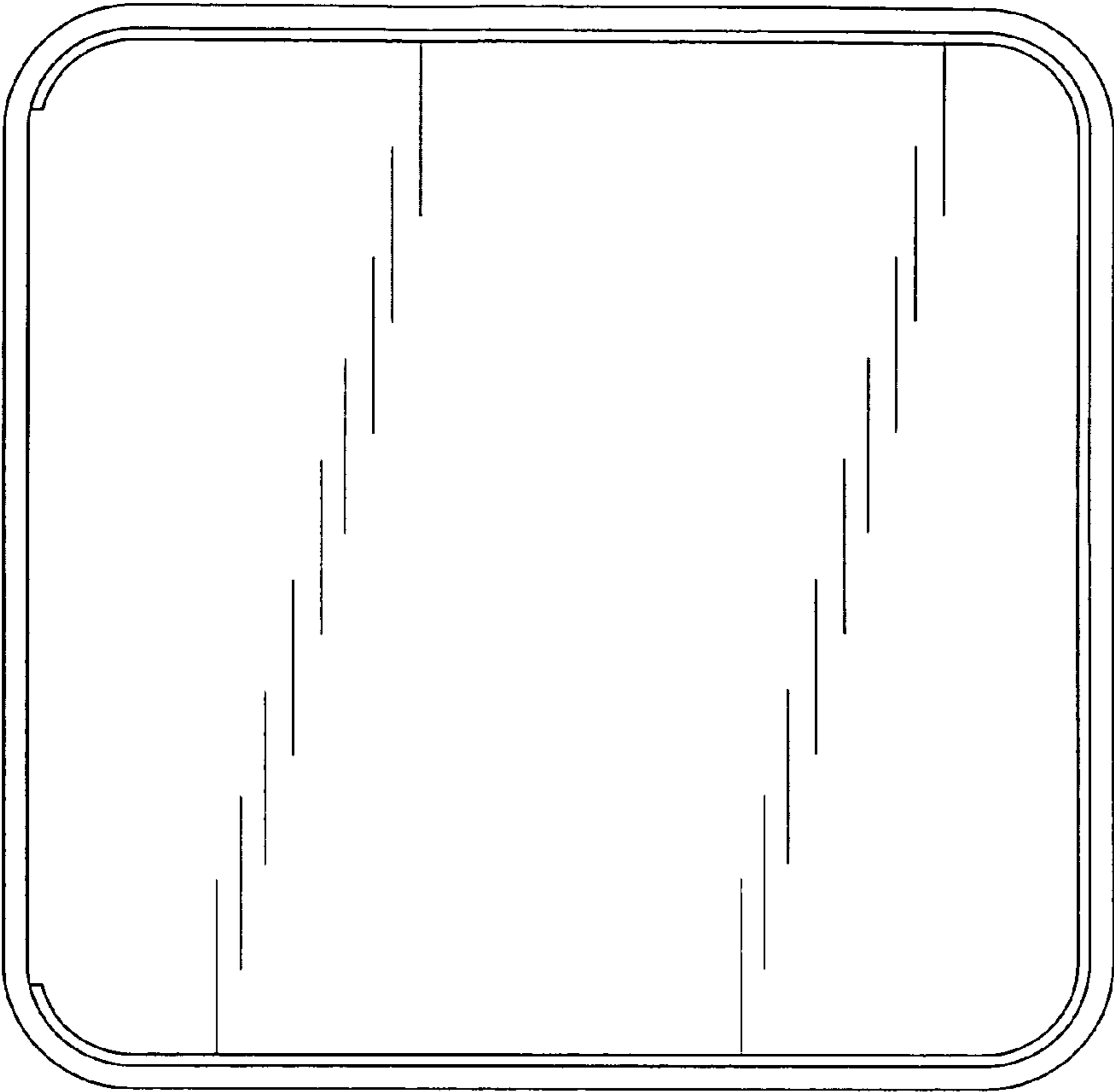

FIG. 3

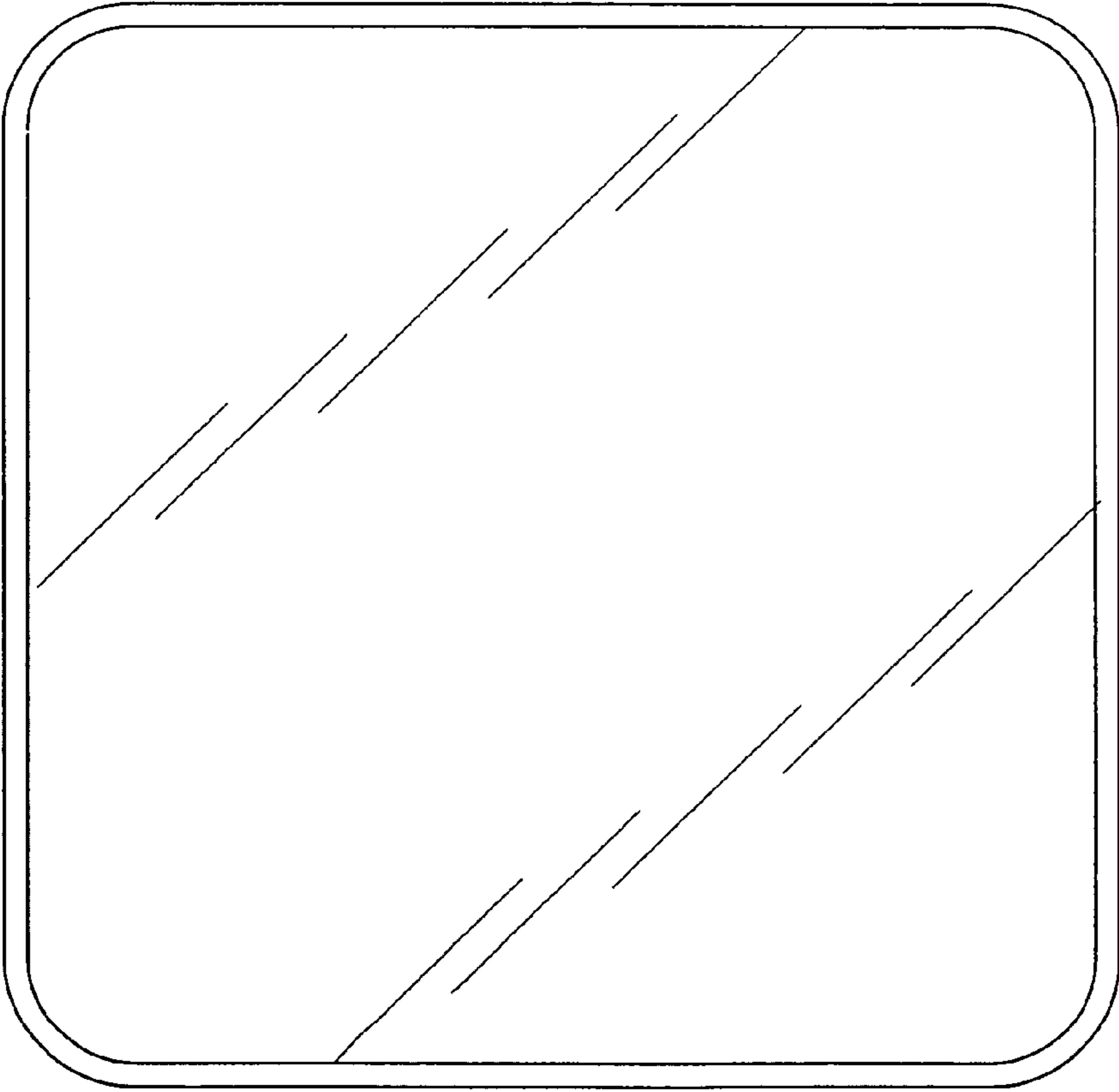

FIG. 2

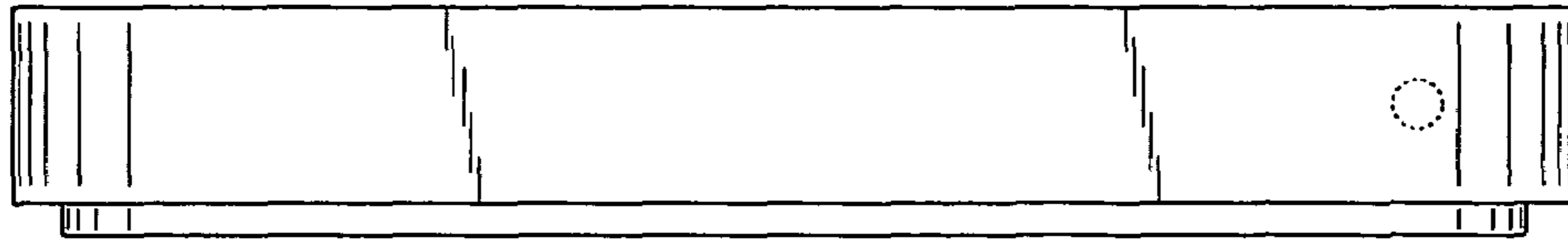

FIG. 4

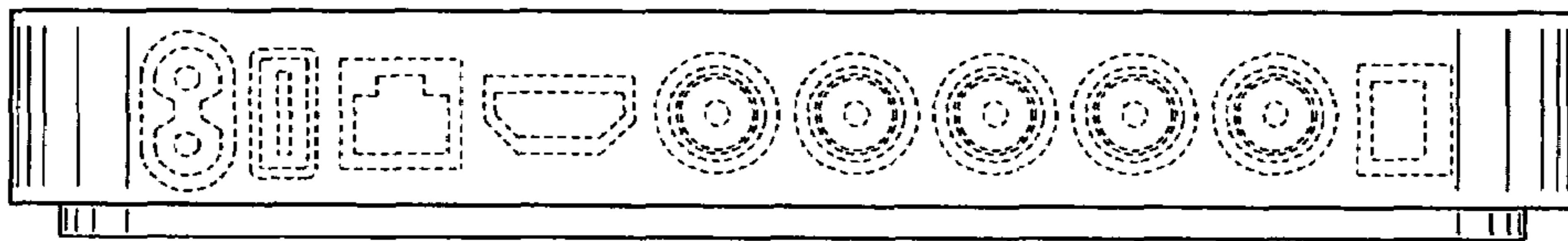

FIG. 5

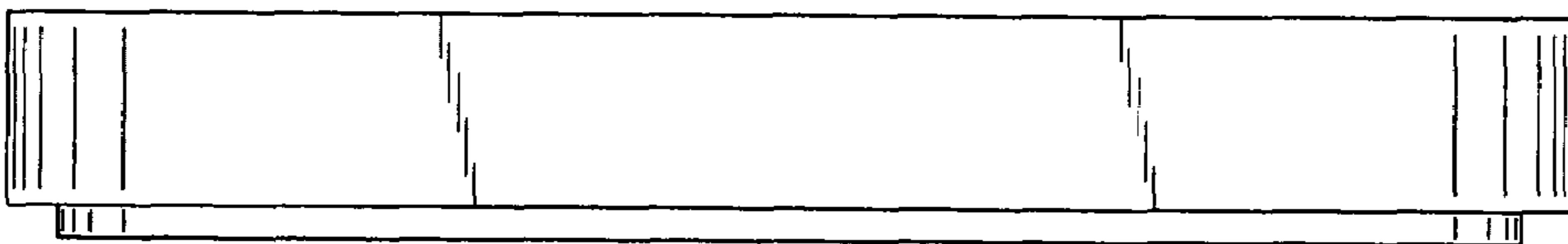

FIG. 6

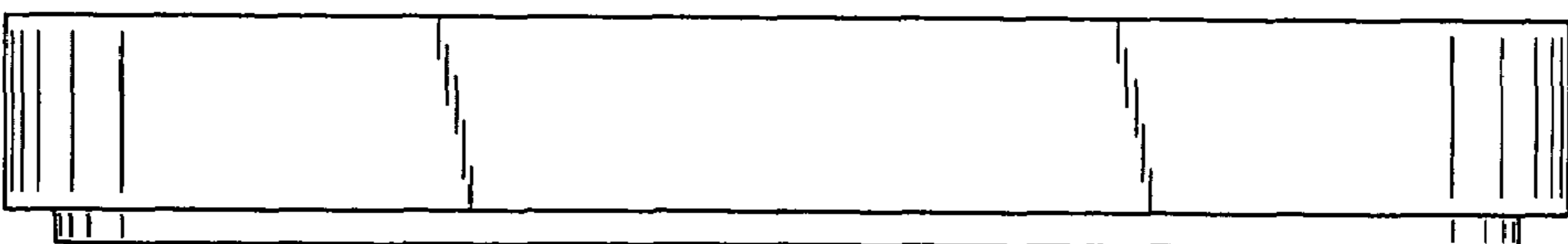

FIG. 7

UNITED STATES PATENT AND TRADEMARK OFFICE
CERTIFICATE OF CORRECTION

PATENT NO. : Des. 601,583 S
APPLICATION NO. : 29/265955
DATED : October 6, 2009
INVENTOR(S) : Bartley K. Andre et al.

Page 1 of 1

It is certified that error appears in the above-identified patent and that said Letters Patent is hereby corrected as shown below:

On the Title page item [75] In the Inventors section on the patent's first page:

Currently:

Douglas B. Salzger, Menlo Park, CA (US)

Calvin O. Seid, Palo Alto, CA (US)

Eugene Anthony Whang, San Francisco, CA (US)

Should be:

Douglas B. Satzger, Menlo Park, CA (US)

Calvin Q. Seid, Palo Alto, CA (US)

Eugene Antony Whang, San Francisco, CA (US)

Signed and Sealed this

Sixteenth Day of February, 2010

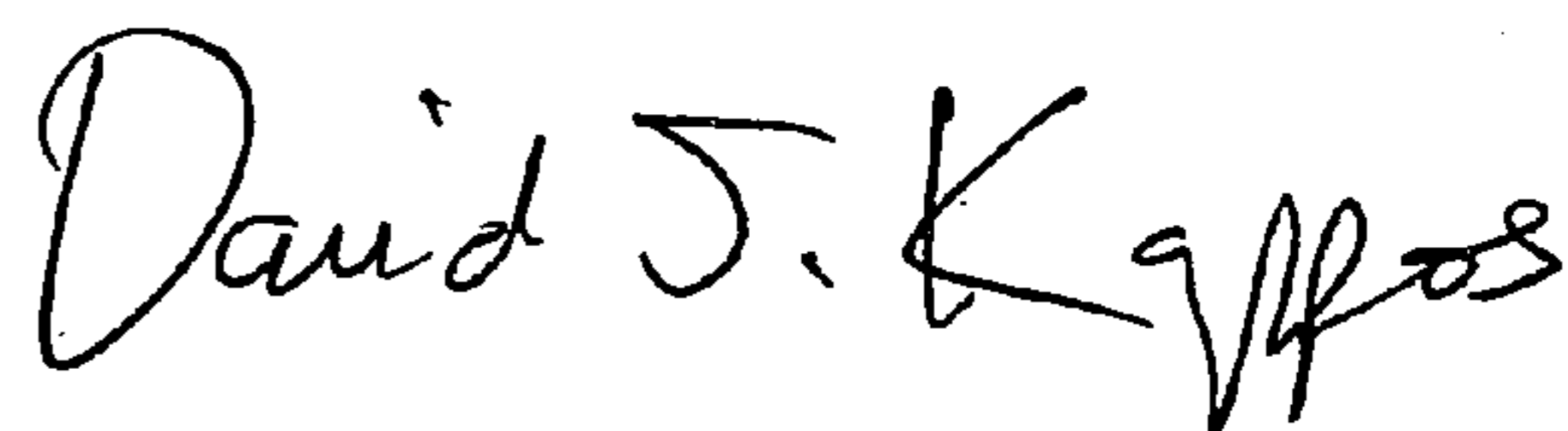

David J. Kappos
Director of the United States Patent and Trademark Office