



US00D601536S

(12) **United States Design Patent**
Chambers

(10) **Patent No.:** **US D601,536 S**

(45) **Date of Patent:** **** Oct. 6, 2009**

(54) **PORTABLE PHONE**

(75) Inventor: **Susanne Chambers**, Rancho Dominguez, CA (US)

(73) Assignee: **Samsung Electronics Co., Ltd.**, Suwon-Si (KR)

(**) Term: **14 Years**

(21) Appl. No.: **29/326,805**

(22) Filed: **Oct. 24, 2008**

(30) **Foreign Application Priority Data**

Aug. 8, 2008 (KR) 30-2008-0034550

(51) **LOC (9) Cl.** **14-03**

(52) **U.S. Cl.** **D14/138 AA; D14/345; D14/346; D14/138 AD**

(58) **Field of Classification Search** D14/138 AA, D14/138 R, 138 AD, 341-347, 432, 439, D14/147; 455/575.1, 575.4, 556.2

See application file for complete search history.

(56) **References Cited**

U.S. PATENT DOCUMENTS

| | | | | |
|--------------|--------|-----------------|-------|------------|
| D322,882 S * | 1/1992 | Botella | | D2/952 |
| D515,541 S * | 2/2006 | Jensfelt | | D14/138 AA |
| D524,786 S * | 7/2006 | Paradise et al. | | D14/138 AA |
| D542,254 S * | 5/2007 | Ahn et al. | | D14/138 AB |
| D543,191 S * | 5/2007 | Kim et al. | | D14/138 AA |
| D545,801 S * | 7/2007 | Joung | | D14/138 AA |
| D560,635 S * | 1/2008 | Kim et al. | | D14/138 AA |
| D561,729 S * | 2/2008 | Kim et al. | | D14/138 AA |
| D562,295 S * | 2/2008 | Lindner et al. | | D14/138 AB |
| D566,093 S * | 4/2008 | Kim et al. | | D14/138 AA |
| D572,692 S * | 7/2008 | Kim et al. | | D14/138 AA |
| D572,698 S * | 7/2008 | Kim et al. | | D14/138 AA |
| D573,130 S * | 7/2008 | Kim et al. | | D14/138 AA |
| D573,970 S * | 7/2008 | Park | | D14/138 AA |
| D574,347 S * | 8/2008 | Lee et al. | | D14/138 AA |
| D575,260 S * | 8/2008 | Liaw | | D14/138 AA |
| D576,990 S * | 9/2008 | Han et al. | | D14/138 AA |
| D577,704 S * | 9/2008 | Park et al. | | D14/138 AD |

| | | | | |
|-------------------|---------|-------------|-------|------------|
| D579,434 S * | 10/2008 | Park et al. | | D14/138 AD |
| D579,910 S * | 11/2008 | Fan et al. | | D14/138 AA |
| D582,373 S * | 12/2008 | Cao et al. | | D14/138 AA |
| D582,376 S * | 12/2008 | Fan et al. | | D14/138 AA |
| D583,343 S * | 12/2008 | Lee et al. | | D14/138 AA |
| D583,352 S * | 12/2008 | Son et al. | | D14/138 AA |
| D591,255 S * | 4/2009 | Lee et al. | | D14/138 AA |
| 2008/0274776 A1 * | 11/2008 | Cho et al. | | 455/575.4 |

OTHER PUBLICATIONS

Samsung T459 Gravity telephone, announced Nov. 2008, [online], [site visited Apr. 25, 2009]. Available from Internet ,<URL: http://www.gsmarena.com>.*

Samsung A637 telephone, announced Oct. 2008, [online], [site visited Apr. 25, 2009]. Available from Internet ,<URL: http://www.gsmarena.com>.*

Vodafone 527 telephone, announced Mar. 2008, [online], [site visited Apr. 25, 2009]. Available from Internet ,<URL: http://www.gsmarena.com>.*

* cited by examiner

Primary Examiner—Jeffrey D Asch

(74) *Attorney, Agent, or Firm*—Staas & Halsey LLP

(57) **CLAIM**

The ornamental design for a portable phone, as shown and described.

DESCRIPTION

FIG. 1 is a perspective view of a portable phone;
FIG. 2 is a front view of the portable phone of FIG. 1;
FIG. 3 is a rear view of the portable phone of FIG. 1;
FIG. 4 is a left-side view of the portable phone of FIG. 1;
FIG. 5 is a right-side view of the portable phone of FIG. 1;
FIG. 6 is a top plan view of the portable phone of FIG. 1;
FIG. 7 is a bottom plan view of the portable phone of FIG. 1;
FIG. 8 is a front open view of the portable phone of FIG. 1;
and,
FIG. 9 is a bottom open view of the portable phone of FIG. 1.

1 Claim, 7 Drawing Sheets

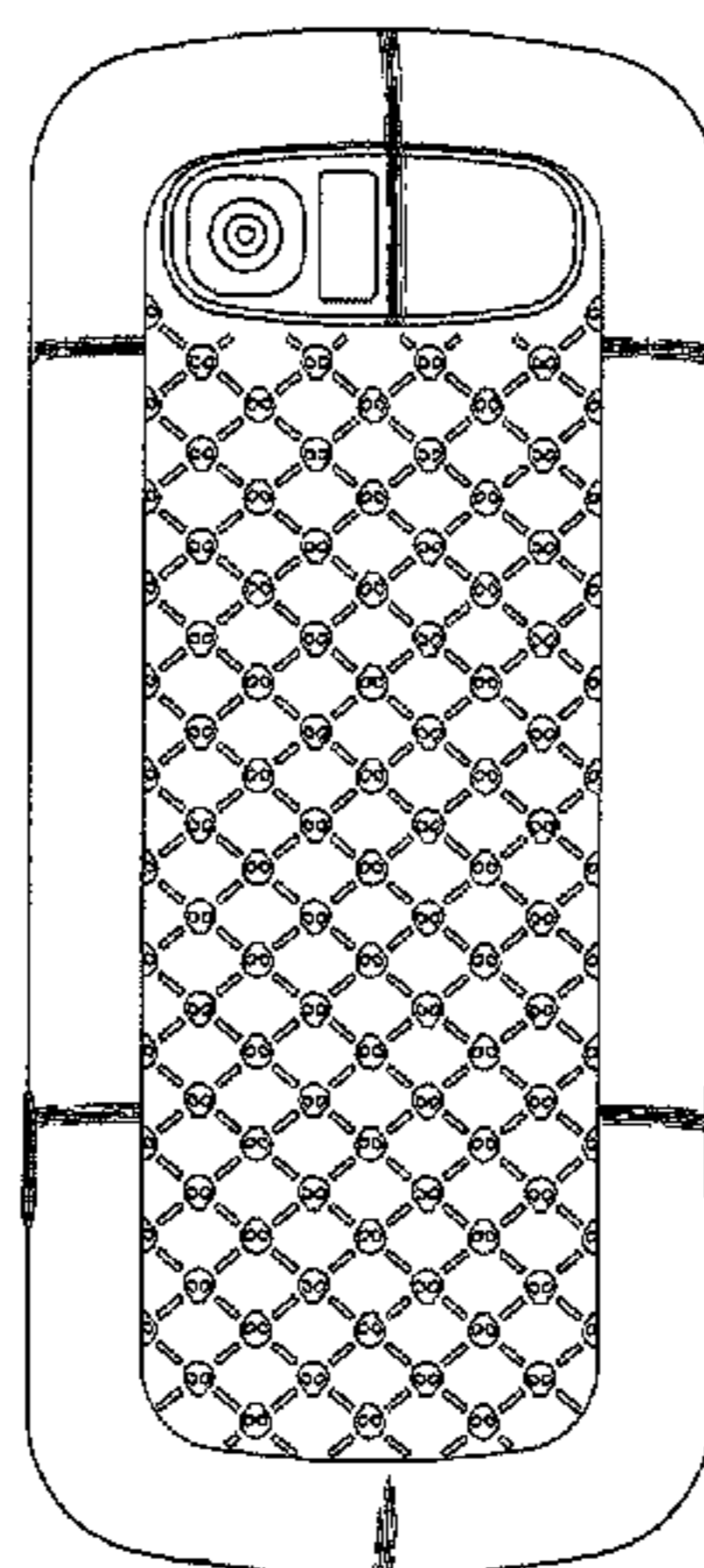
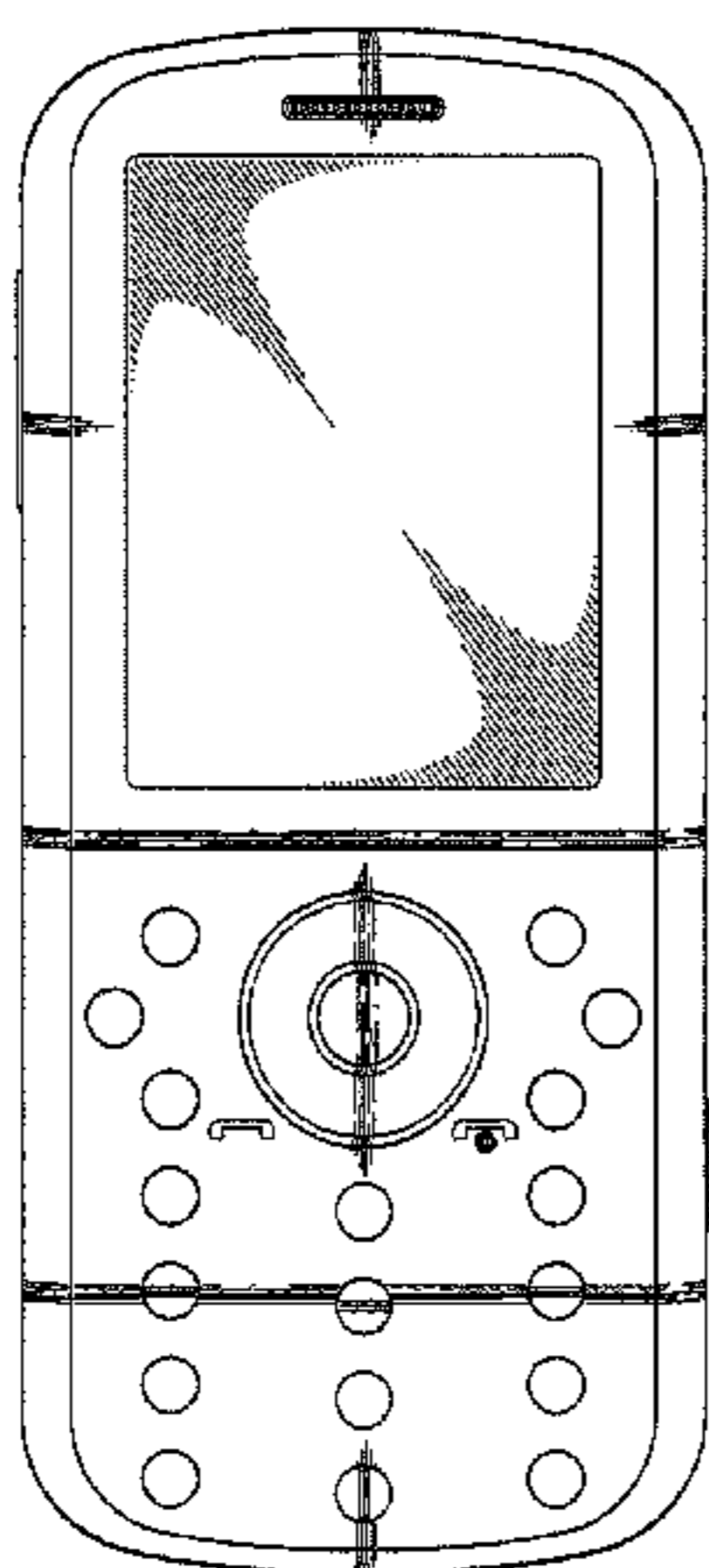

FIG. 1

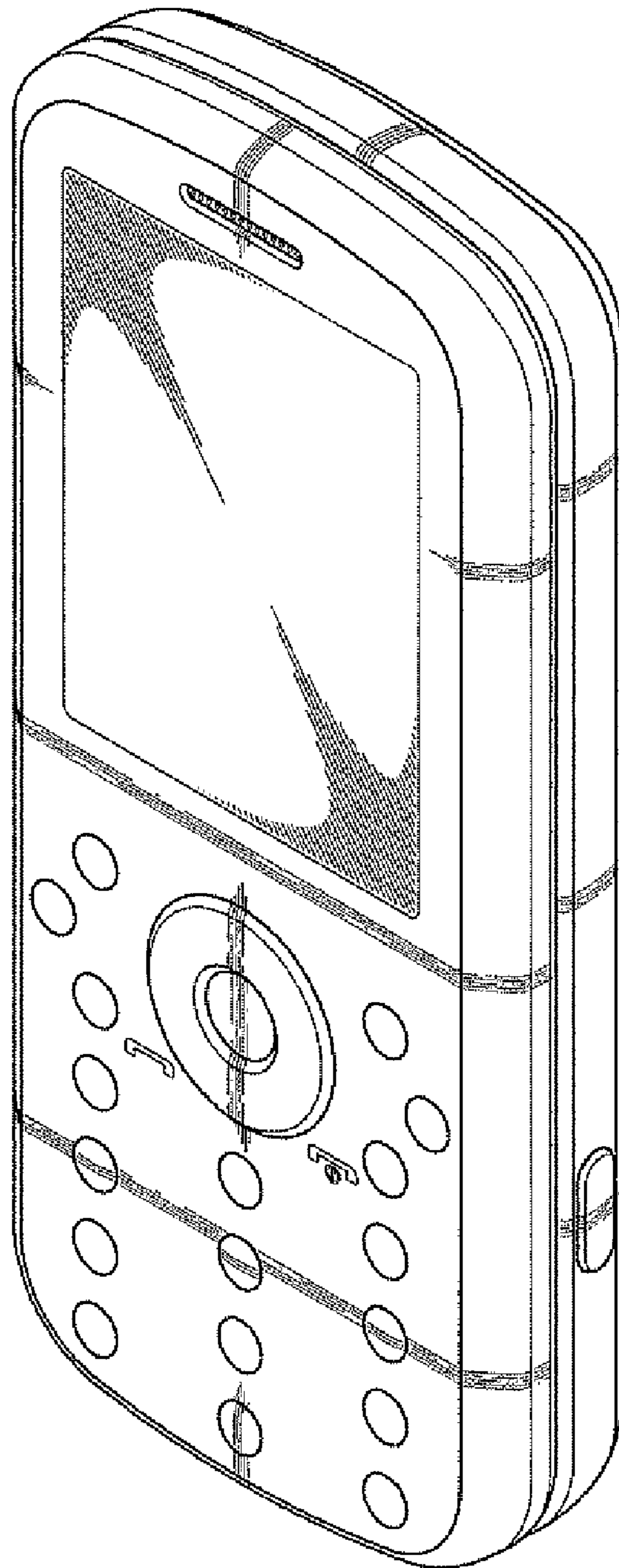

FIG. 2

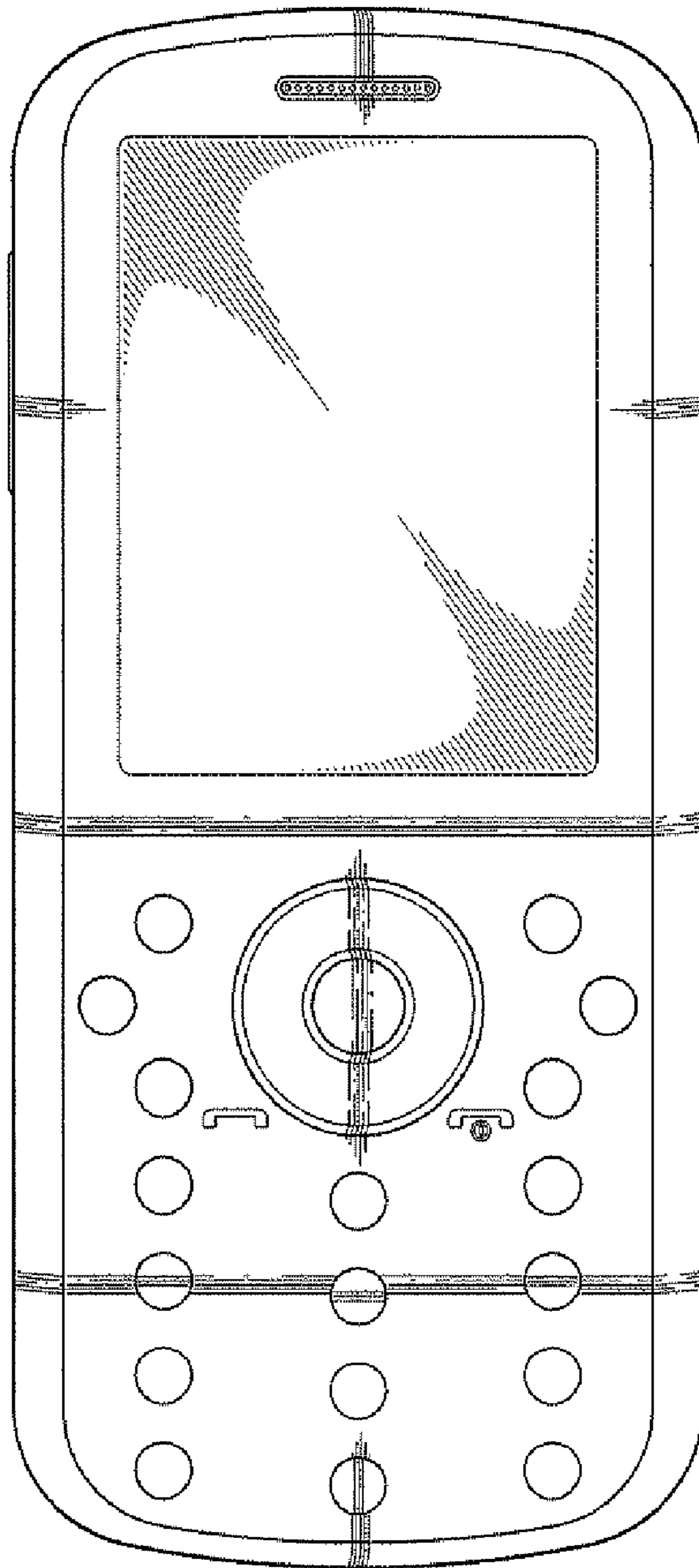

FIG. 3

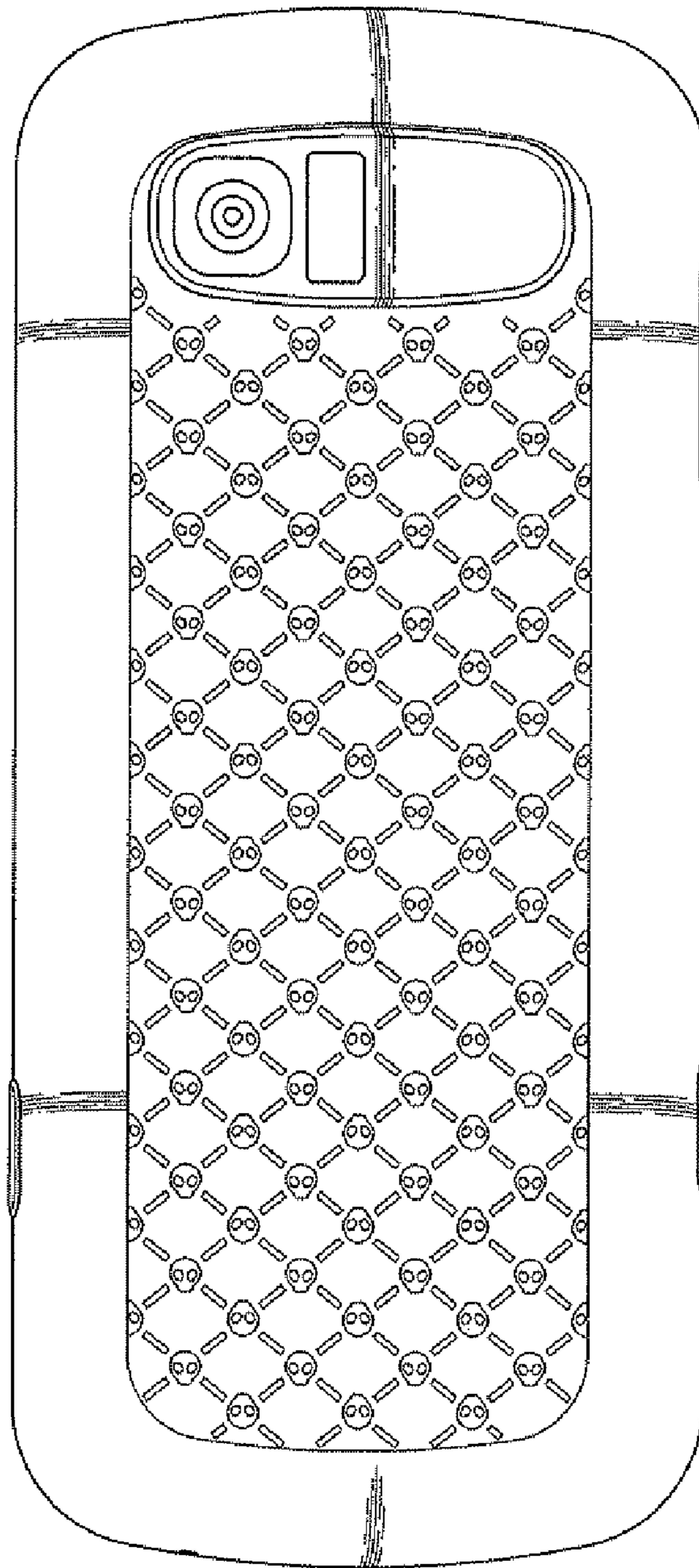

FIG. 4

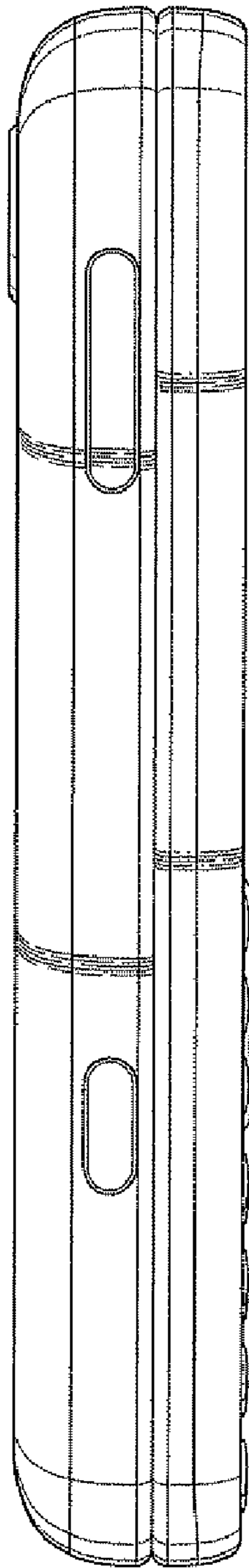

FIG. 5

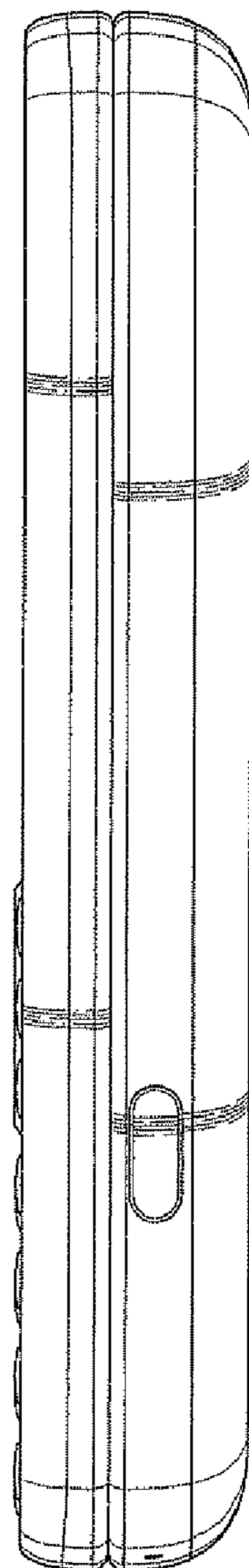

FIG. 6

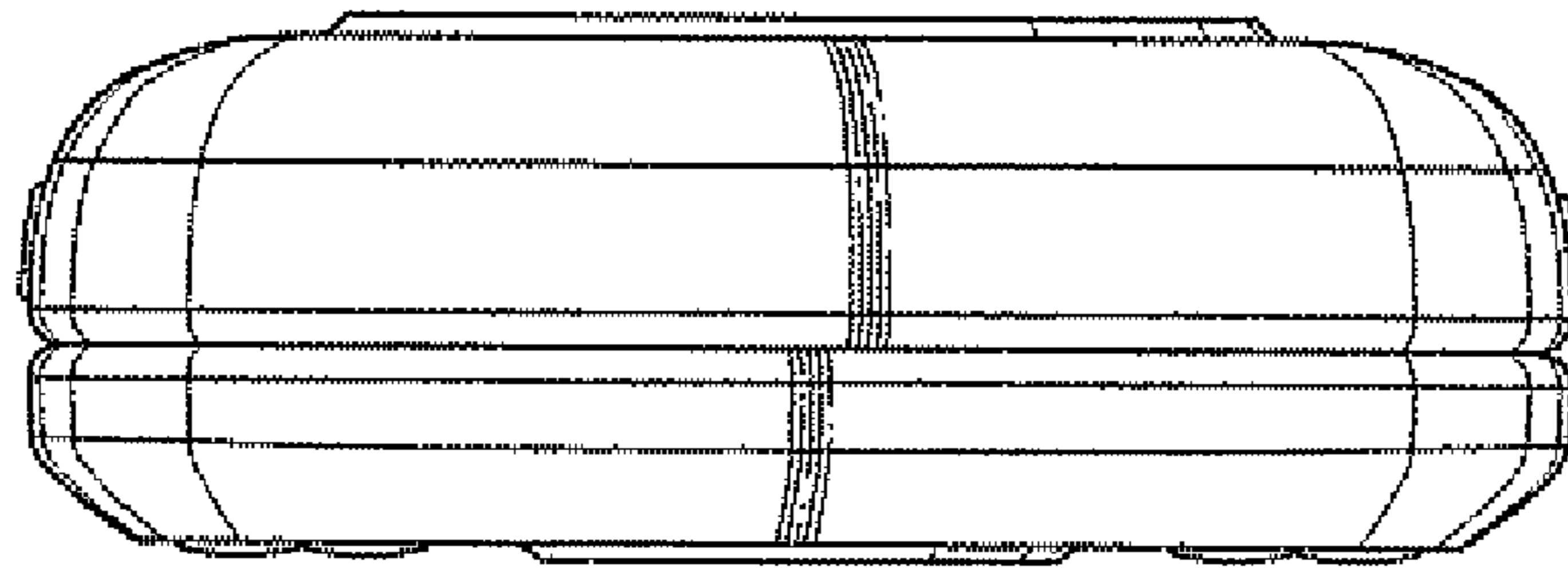

FIG. 7

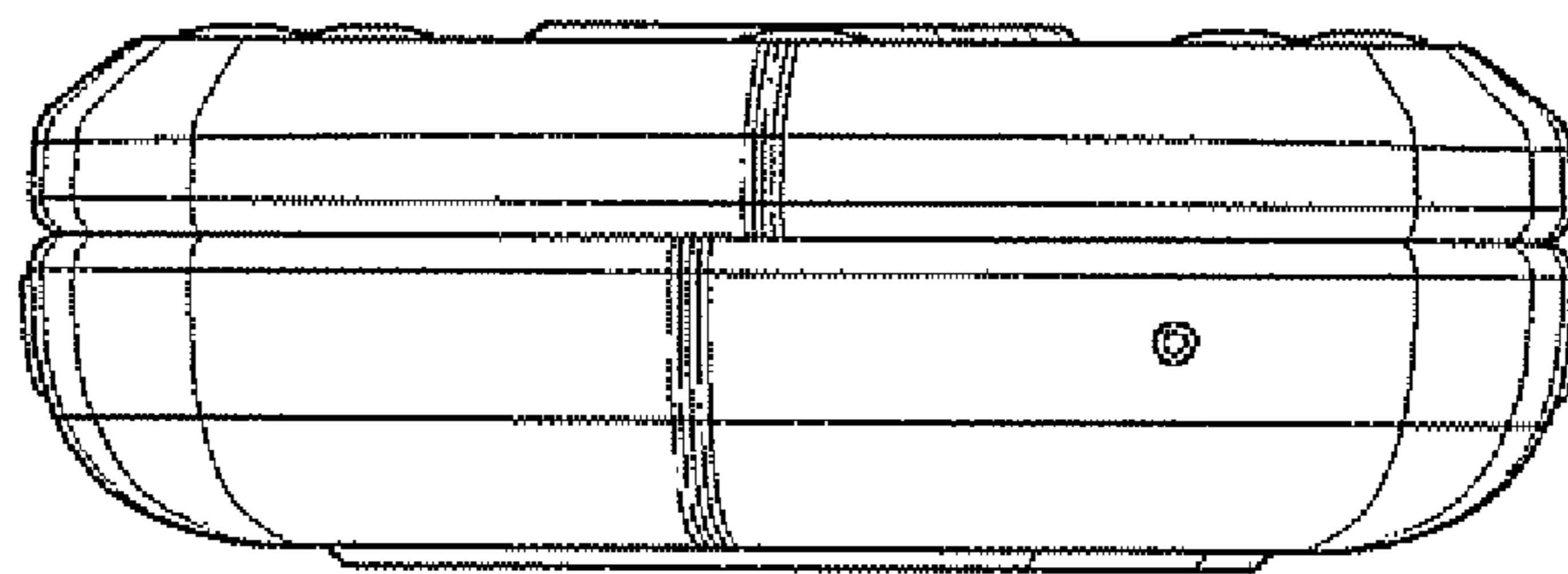

FIG. 8

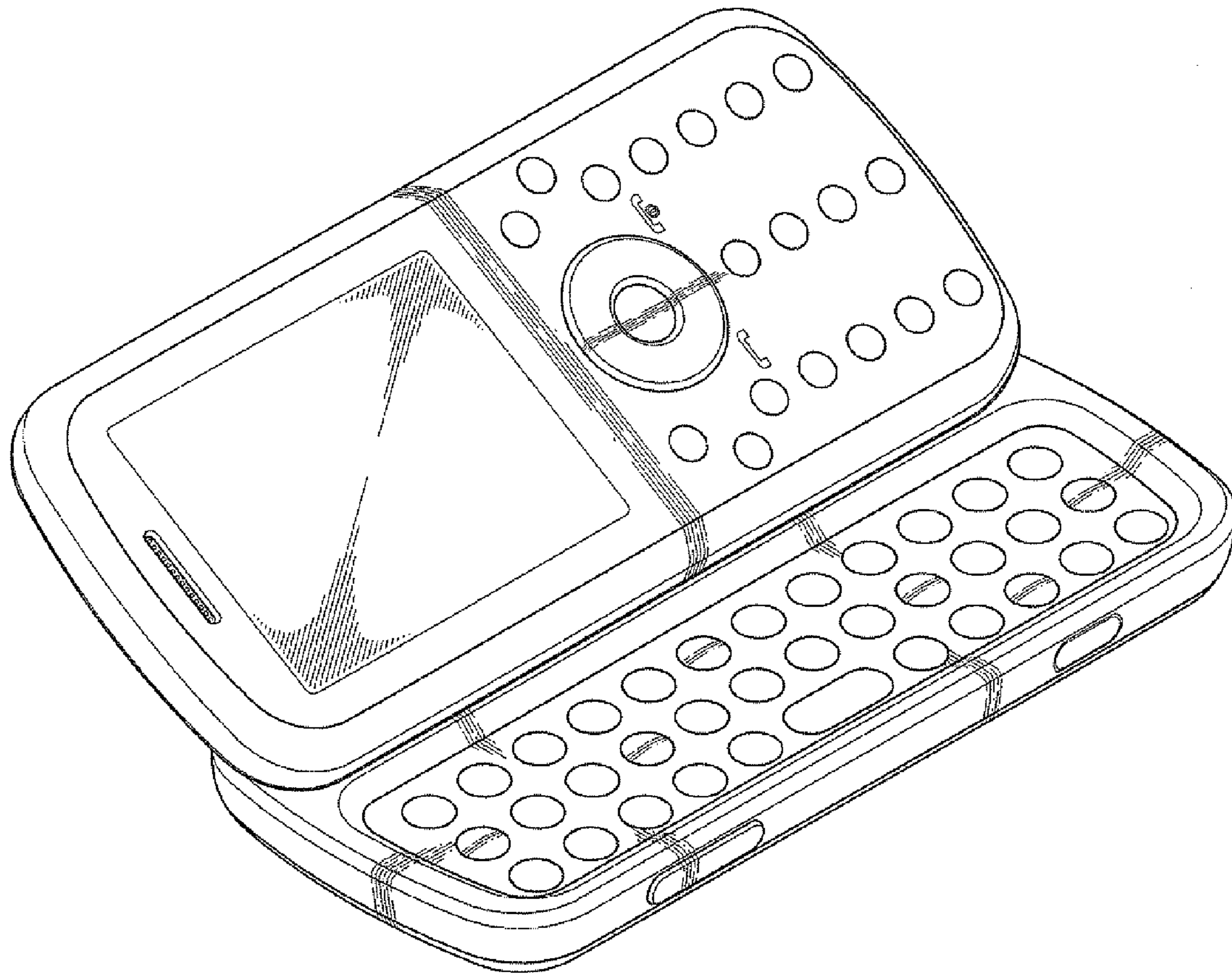

FIG. 9

