



US00D601435S

(12) **United States Design Patent**
Fell et al.

(10) **Patent No.:** **US D601,435 S**
(45) **Date of Patent:** **** Oct. 6, 2009**

(54) **CIGARETTE PACKET**

D594,742 S * 6/2009 Meier et al. D9/432

(75) Inventors: **John Fell**, Cumbria (GB); **Barry Frizell**,
Cumbria (GB); **Wolfgang Zimmerer**,
Cumbria (GB)

(73) Assignee: **Innovia Films Limited** (GB)

(**) Term: **14 Years**

(21) Appl. No.: **29/333,750**

(22) Filed: **Mar. 13, 2009**

(30) **Foreign Application Priority Data**

Oct. 3, 2008 (EM) 001014310-0001

(51) **LOC (9) Cl.** **09-05**

(52) **U.S. Cl.** **D9/713**

(58) **Field of Classification Search** D9/430-433,
D9/423, 425, 713-714, 414, 424; 206/265,
206/236; 229/160.1, 87.13, 160.2, 125.19,
229/120.08; D27/183-191

See application file for complete search history.

(56) **References Cited**

U.S. PATENT DOCUMENTS

- D266,224 S * 9/1982 Bronander, Jr. D9/721
- D427,369 S * 6/2000 Bowen et al. D27/189
- 7,377,384 B2 * 5/2008 Mitten et al. 206/256
- D592,525 S 5/2009 Maude et al.
- D592,526 S 5/2009 Maude et al.

OTHER PUBLICATIONS

- U.S. Appl. No. 12/353,478, filed Jan. 12, 2009, Fell et al.
- U.S. Appl. No. 29/333,763, filed Mar. 13, 2009, Frizell et al.
- U.S. Appl. No. 29/333,756, filed Mar. 13, 2009, Fell et al.

* cited by examiner

Primary Examiner—Joel Sincavage

Assistant Examiner—Abraham Bahta

(74) *Attorney, Agent, or Firm*—Knobbe, Martens, Olson &
Bear, LLP

(57) **CLAIM**

The ornamental design for a cigarette packet, as shown and described.

DESCRIPTION

FIG. 1 is a left front perspective view showing the new design;
 FIG. 2 is a bottom view;
 FIG. 3 is a left side view;
 FIG. 4 is a top view;
 FIG. 5 is a right side view;
 FIG. 6 is a left end view; and,
 FIG. 7 is a right end view.

The broken lines in FIGS. 1 and 3 through 7 are included for the purpose of illustrating features of the cigarette packet that form no part of the claimed design.

1 Claim, 2 Drawing Sheets

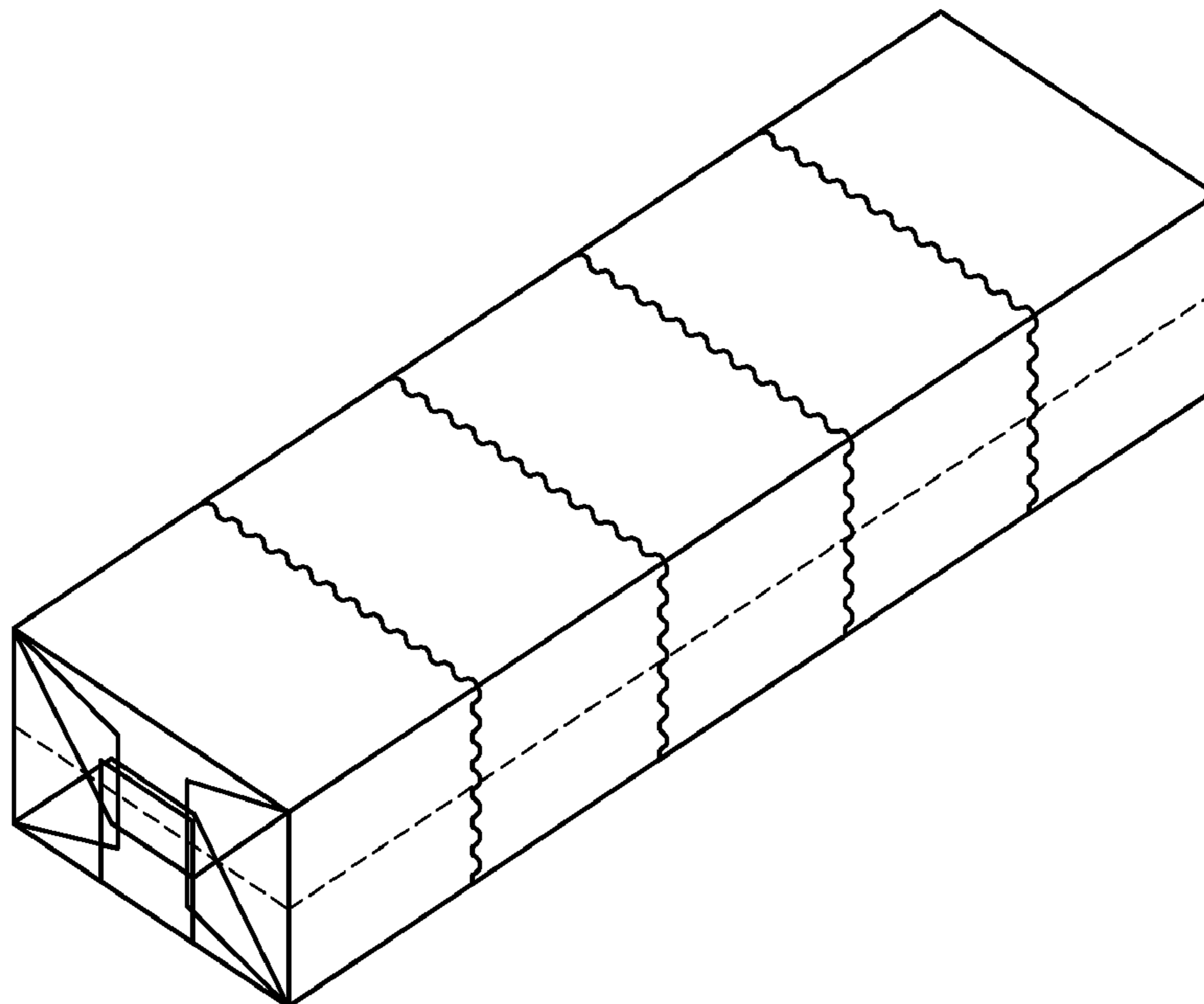

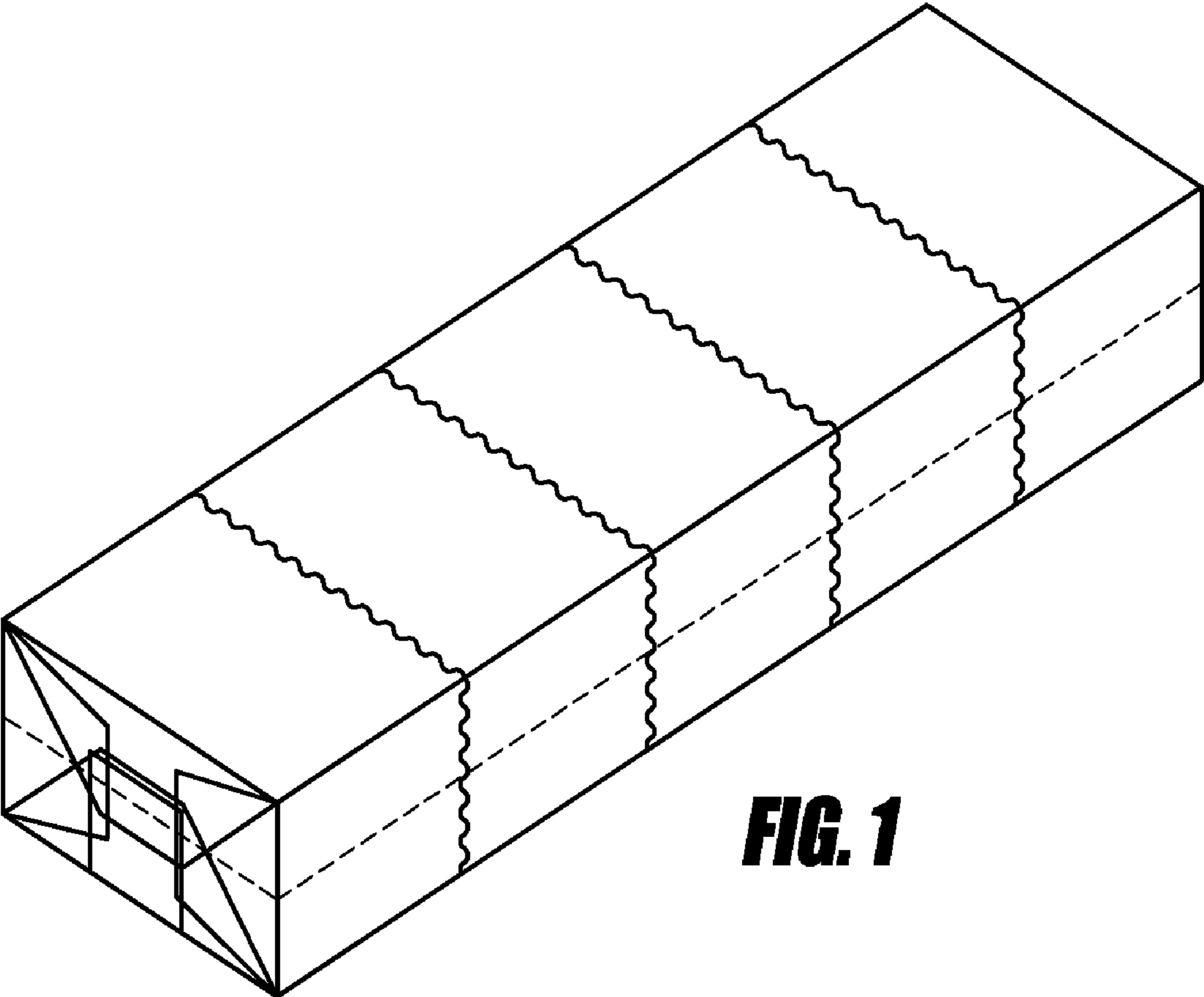

FIG. 1

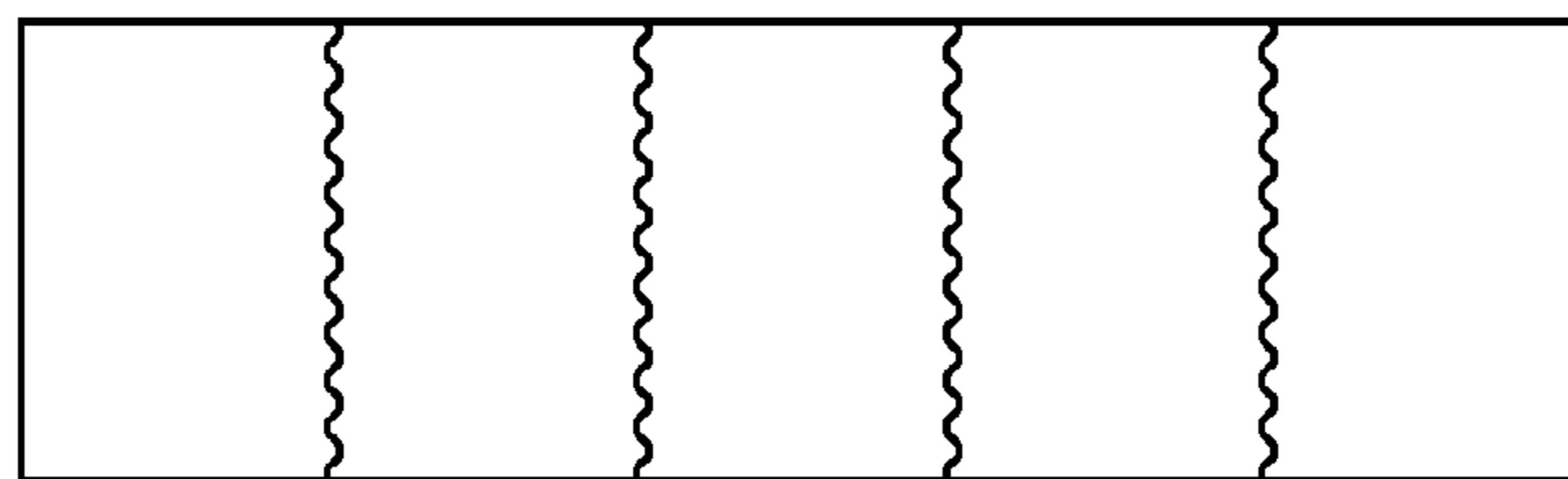

FIG. 2

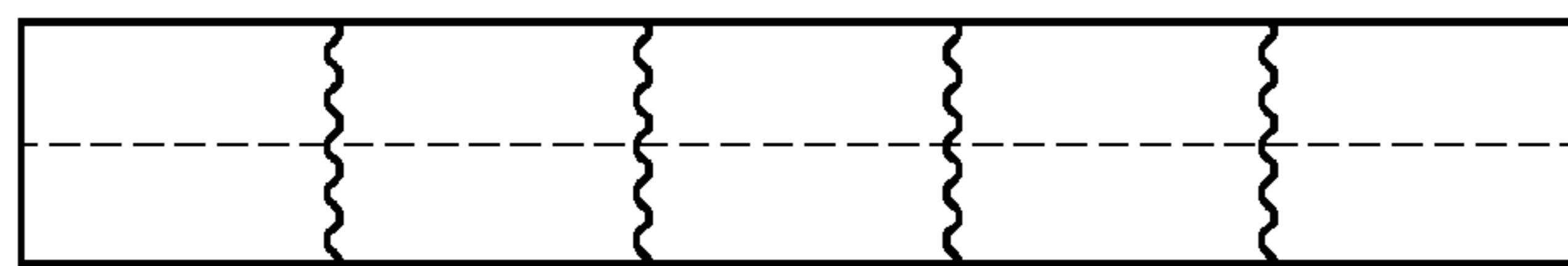

FIG. 3

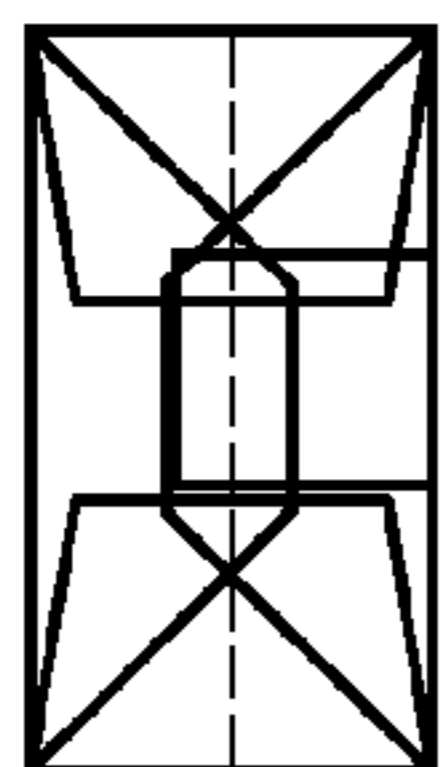

FIG. 6

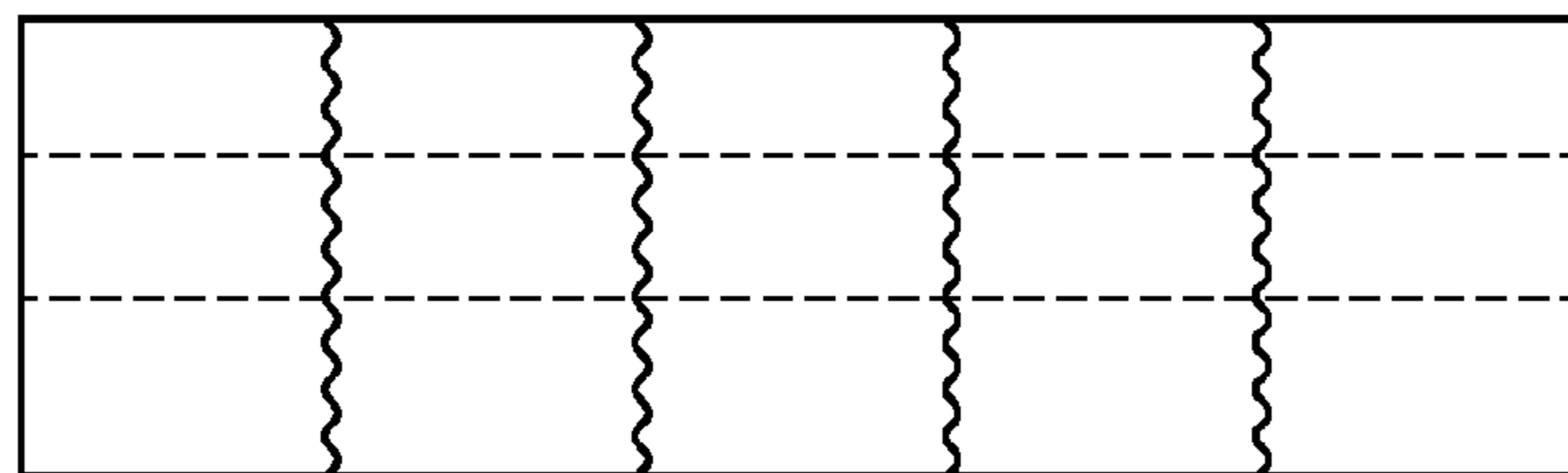

FIG. 4

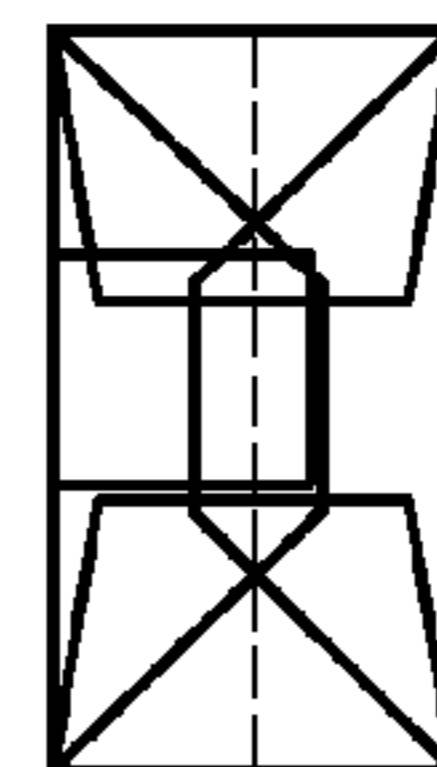

FIG. 7

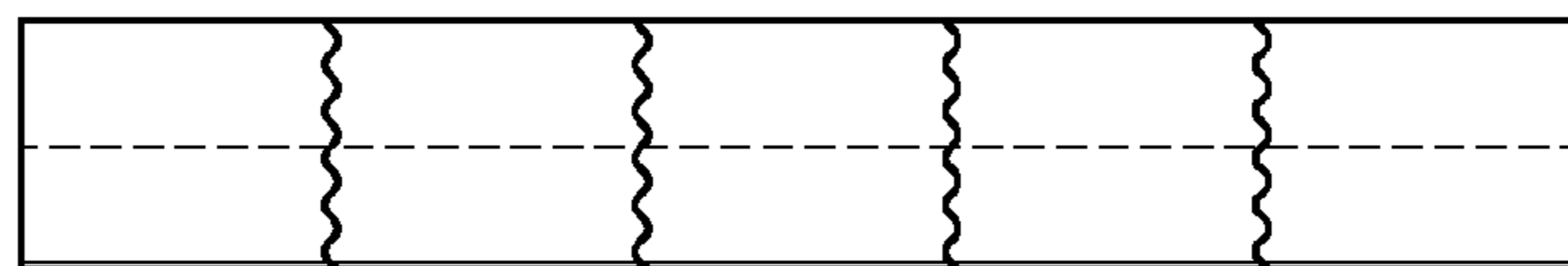

FIG. 5