



US00D601371S

(12) **United States Design Patent**
Thompson

(10) **Patent No.:** **US D601,371 S**
(45) **Date of Patent:** **** Oct. 6, 2009**

(54) **FILAGREE DESIGN FURNITURE COMPONENT**

(75) Inventor: **David W. Thompson**, New Albany, OH (US)

(73) Assignee: **American Signature, Inc.**, Columbus, OH (US)

(**) Term: **14 Years**

(21) Appl. No.: **29/336,251**

(22) Filed: **Apr. 30, 2009**

Related U.S. Application Data

(62) Division of application No. 29/324,447, filed on Sep. 12, 2008, now Pat. No. Des. 591,987.

(51) **LOC (9) Cl.** **06-06**

(52) **U.S. Cl.** **D6/495**

(58) **Field of Classification Search** D6/389, D6/393, 432-448, 470-472, 477-479, 505, D6/509; 5/53.1, 279.1, 280-281, 907; 211/41.41, 211/42, 74, 90.01, 133.1; 312/7.2, 9.1, 114, 312/117-118, 204, 224, 237, 251.1, 241, 312/278-279

See application file for complete search history.

(56) **References Cited**

U.S. PATENT DOCUMENTS

D469,982 S *	2/2003	Warren et al.	D6/432
D480,898 S *	10/2003	Schmitt	D6/470
D526,510 S *	8/2006	Schmitt	D6/441
D564,795 S *	3/2008	Schmitt	D6/470
D591,987 S *	5/2009	Thompson	D6/509

* cited by examiner

Primary Examiner—Caron Veynar
Assistant Examiner—Ricky Pham

(74) *Attorney, Agent, or Firm*—Wood, Herron & Evans, L.L.P.

(57) **CLAIM**

The ornamental design for a filigree design furniture component, as shown and described.

DESCRIPTION

FIG. 1 is an enlarged perspective view of a first embodiment of my new design.

FIG. 2 is a front elevational view thereof.

FIG. 3 is an enlarged left side elevational view thereof.

FIG. 4 is another front elevational view thereof.

FIG. 5 is a cross-sectional view along line 5—5 of FIG. 3.

FIG. 6 is a cross-sectional view along line 6—6 of FIG. 3.

FIG. 7 is a top plan view thereof.

FIG. 8 is a bottom plan view thereof.

FIG. 9 is an enlarged perspective view of a second embodiment of my new design.

FIG. 10 is a front elevational view thereof.

FIG. 11 is an enlarged left side elevational view thereof.

FIG. 12 is another front elevational view thereof.

FIG. 13 is a cross-sectional view along line 13—13 of FIG. 11.

FIG. 14. Is a cross-sectional view along line 14—14 of FIG. 11.

FIG. 15 is a top plan view thereof; and,

FIG. 16 is a bottom plan view thereof.

The broken lines in FIGS. 2 and 10, are for illustrative purposes only and form no part of the claimed filigree design furniture component.

1 Claim, 7 Drawing Sheets

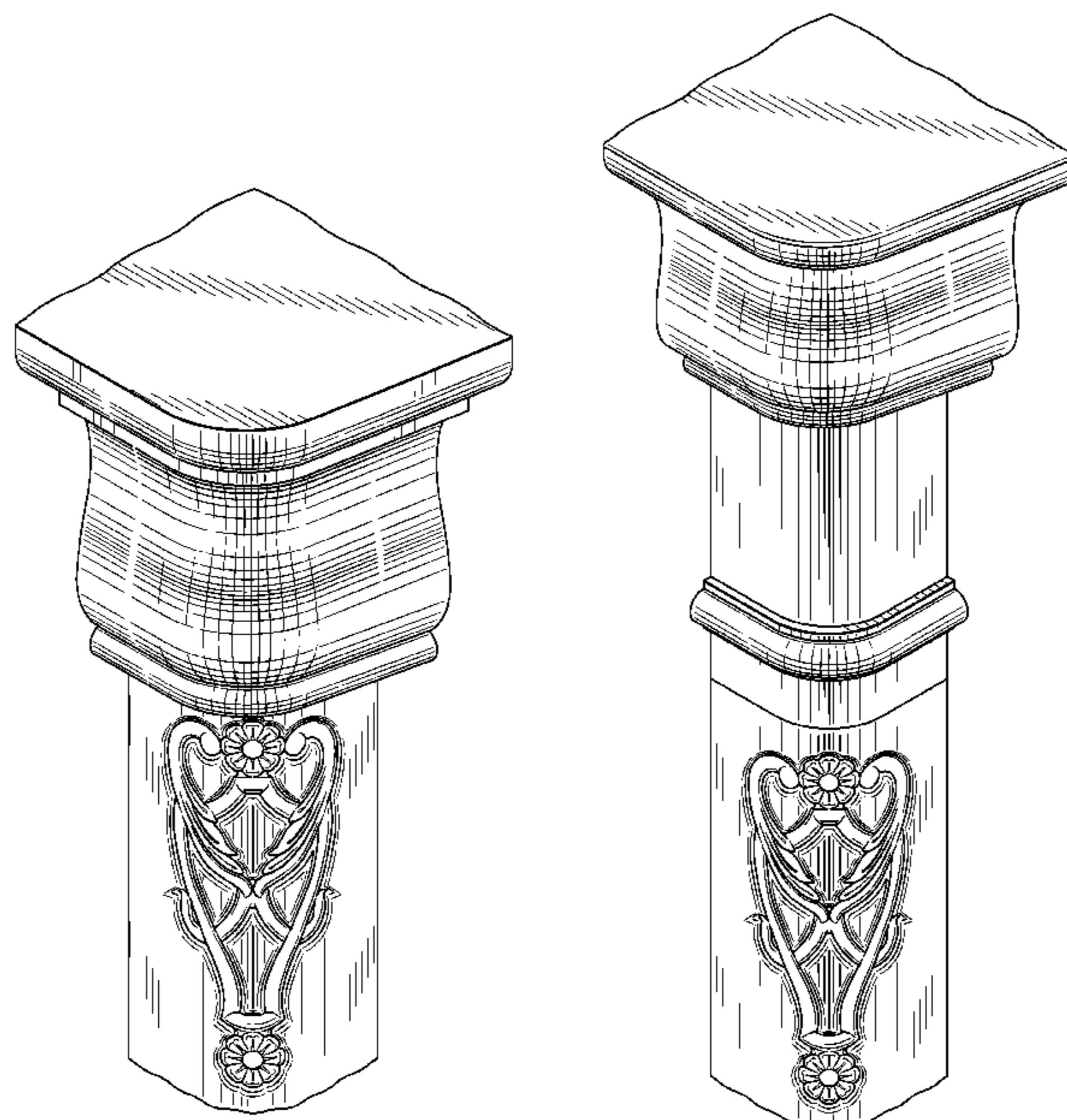

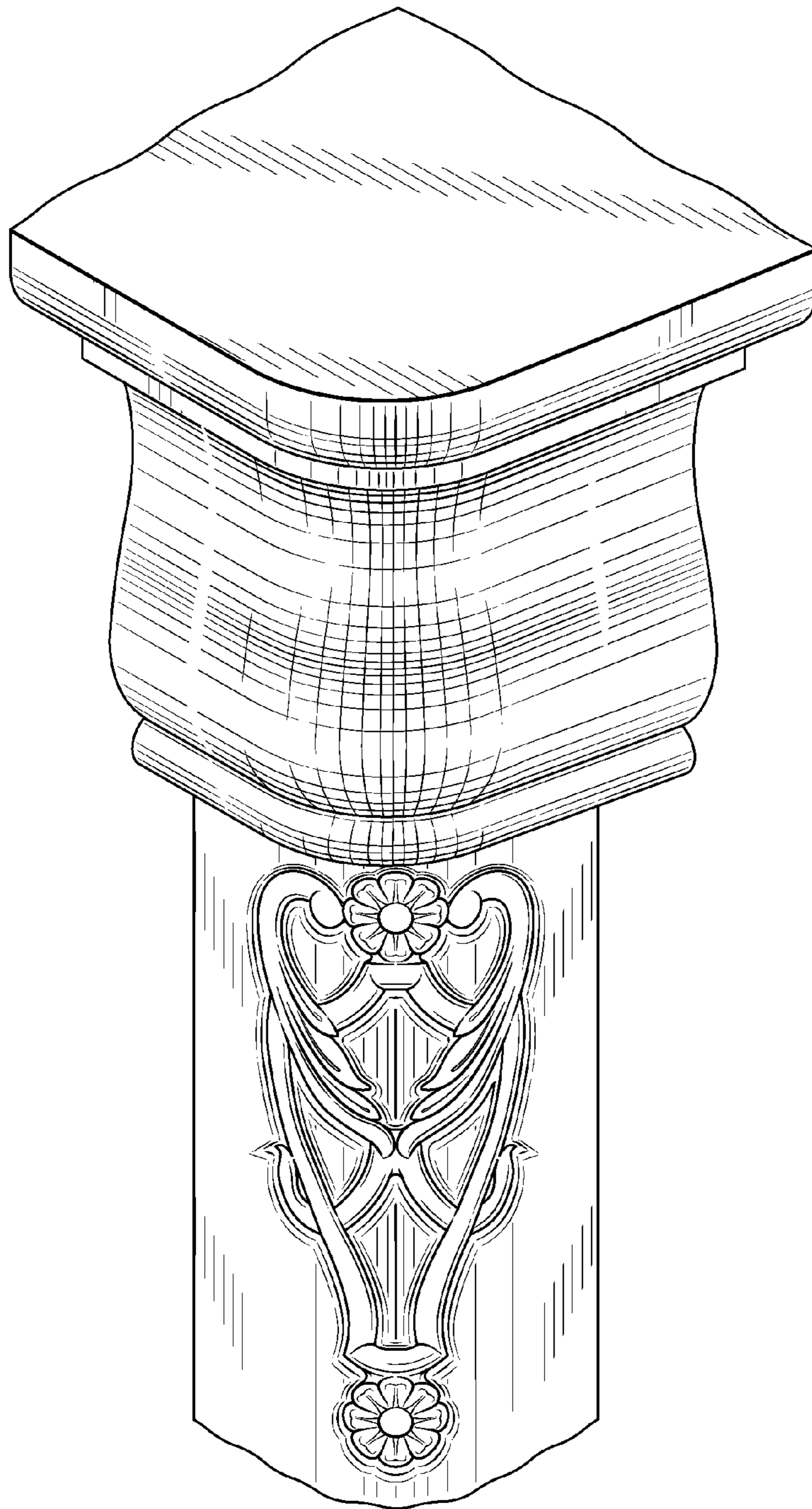

FIG. 1

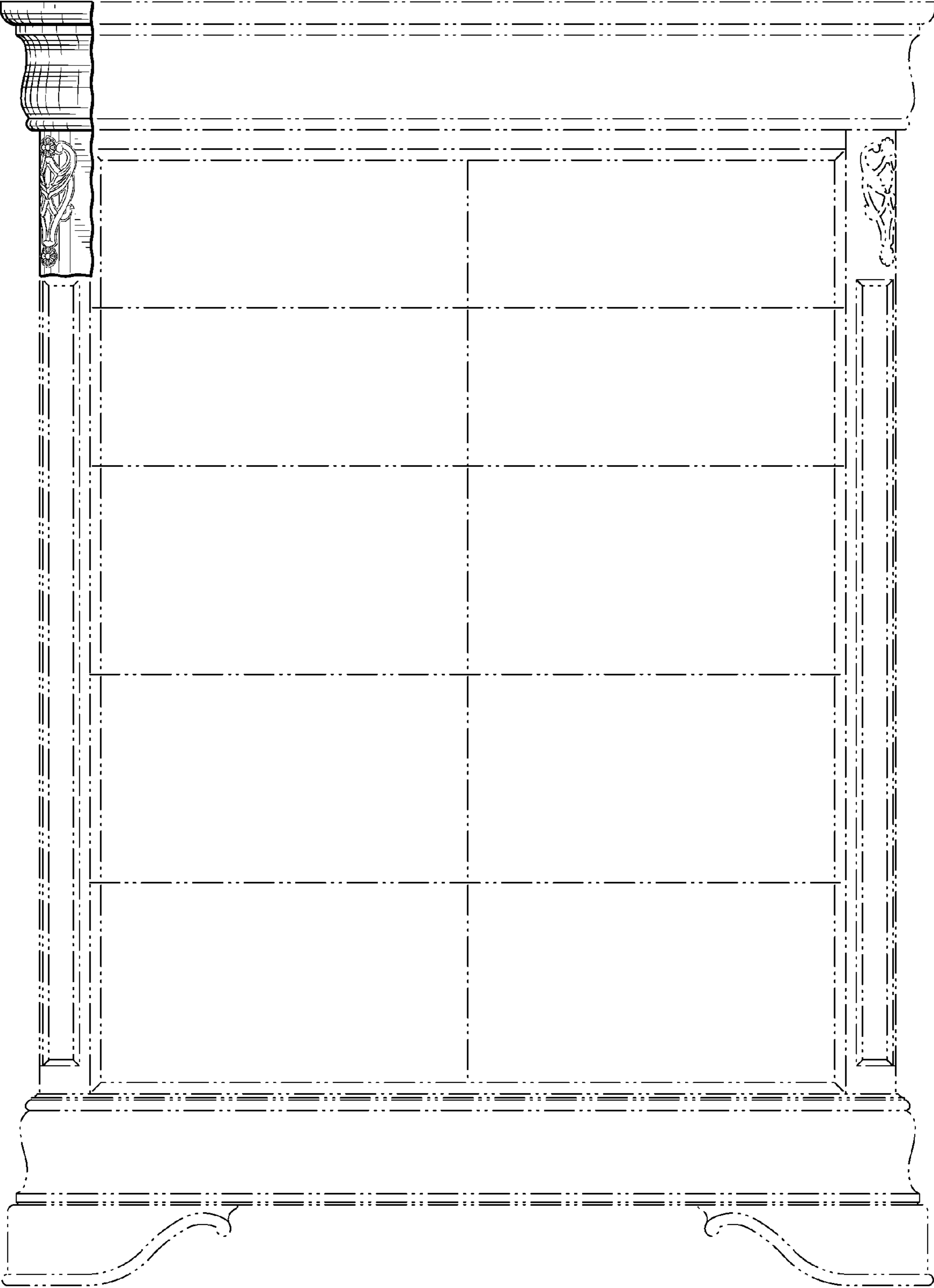

FIG. 2

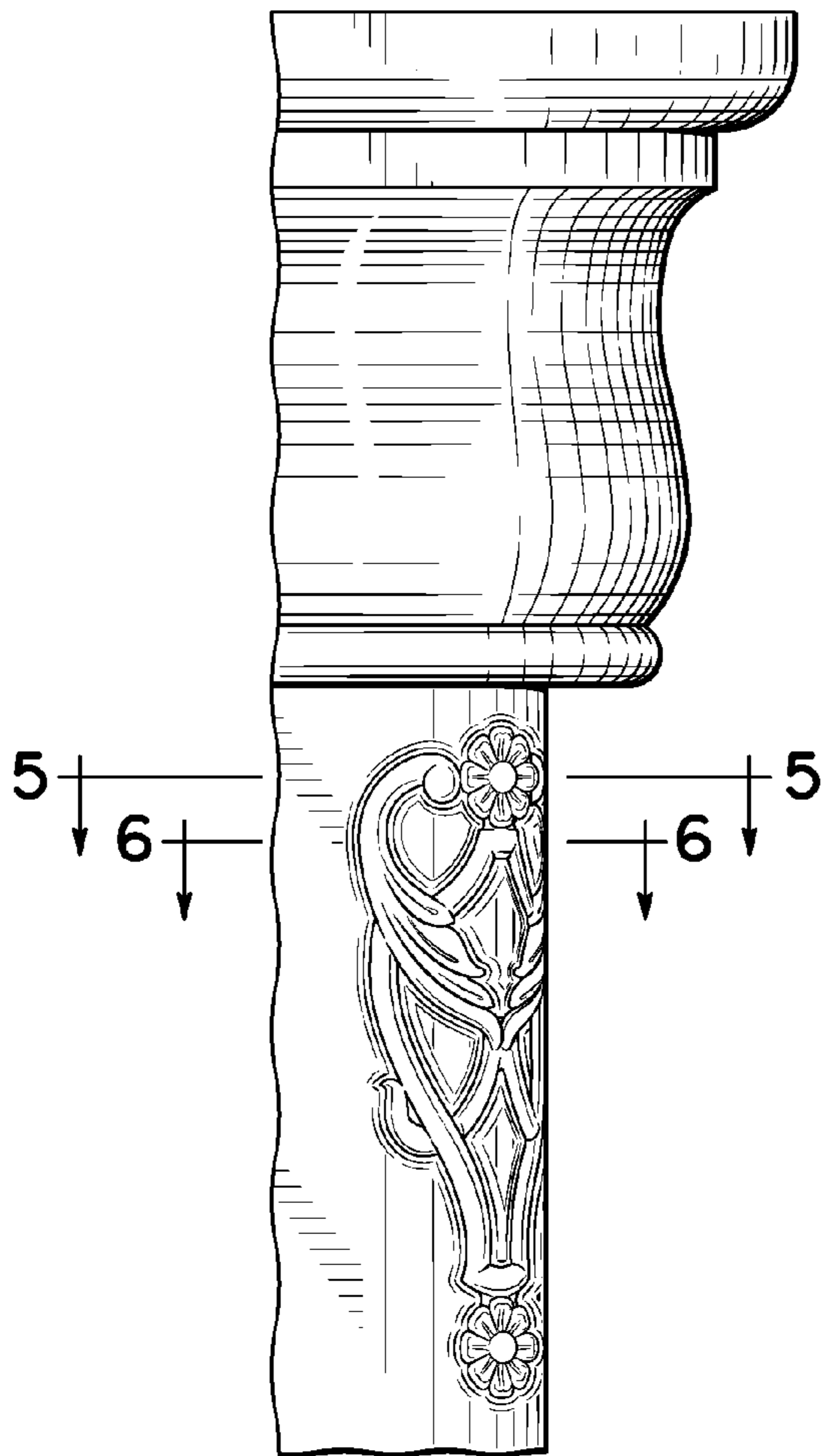

FIG. 3

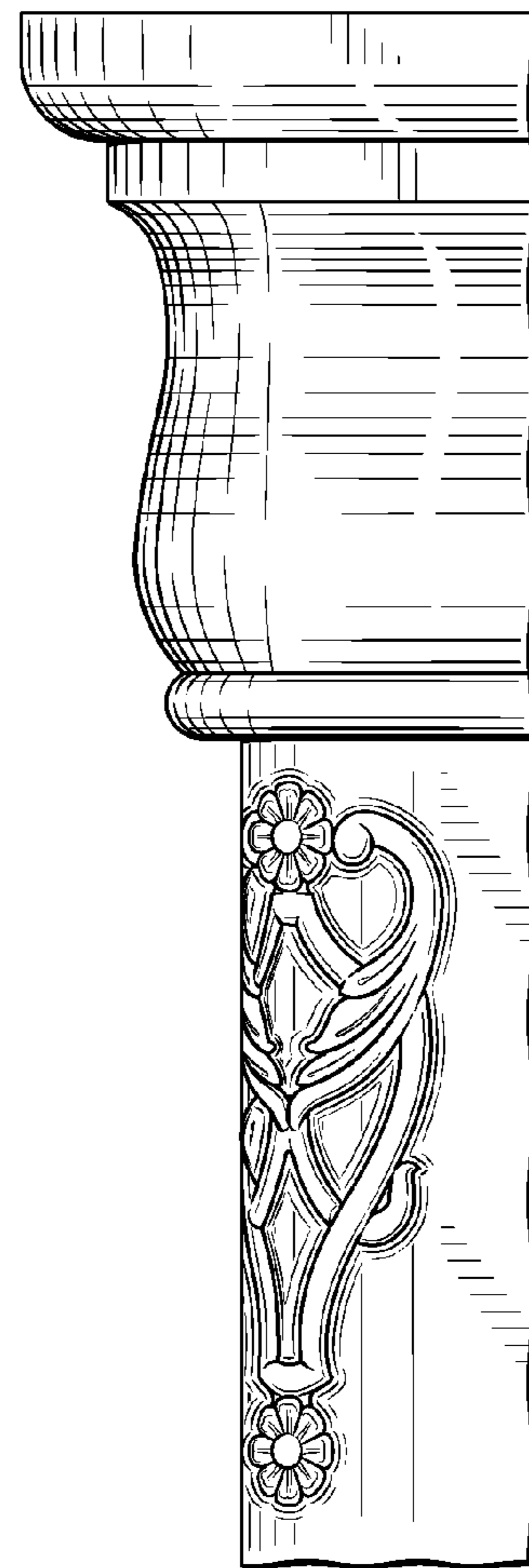

FIG. 4

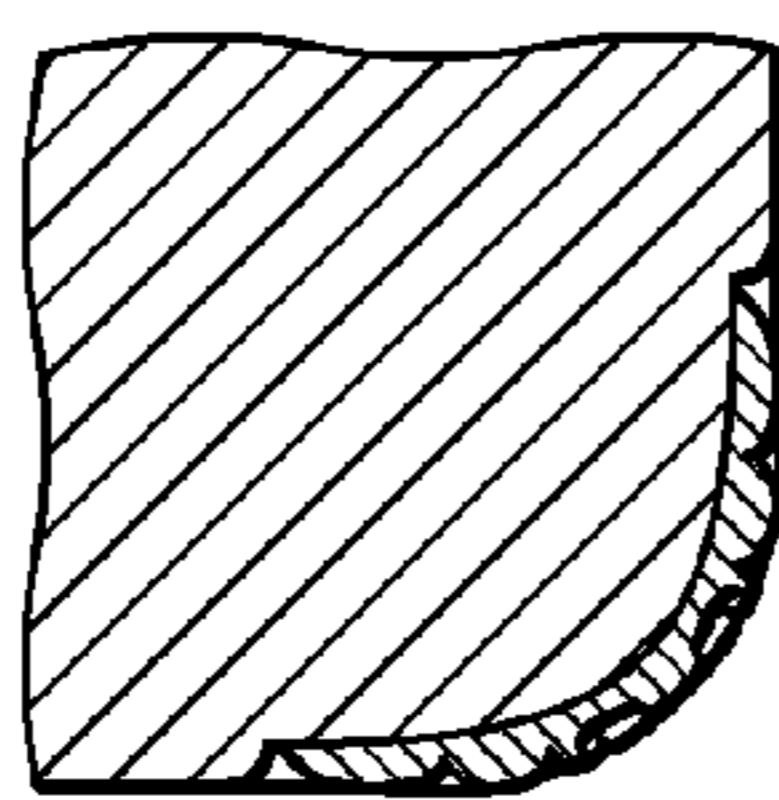

FIG. 5

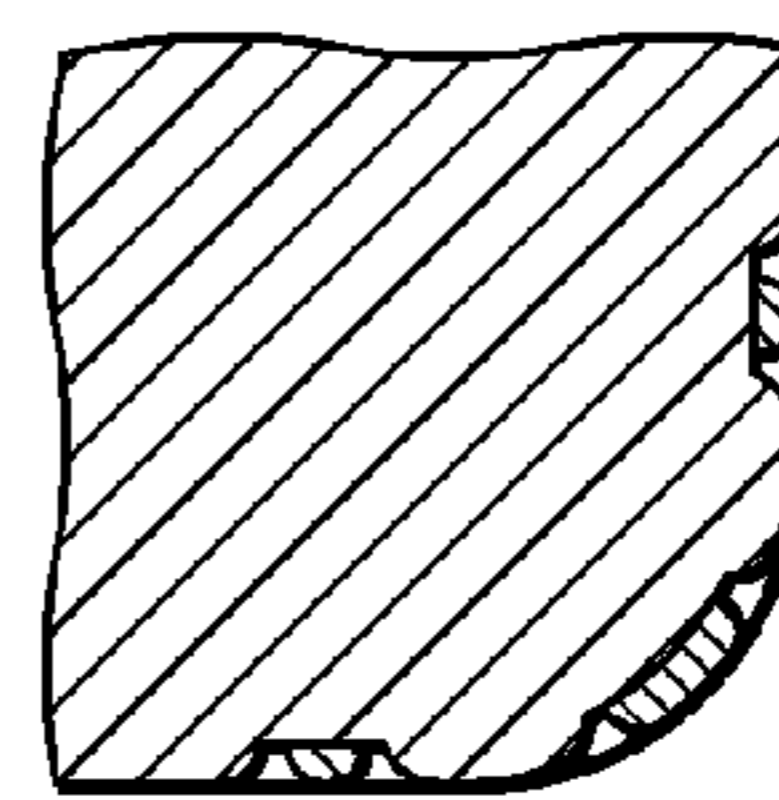

FIG. 6

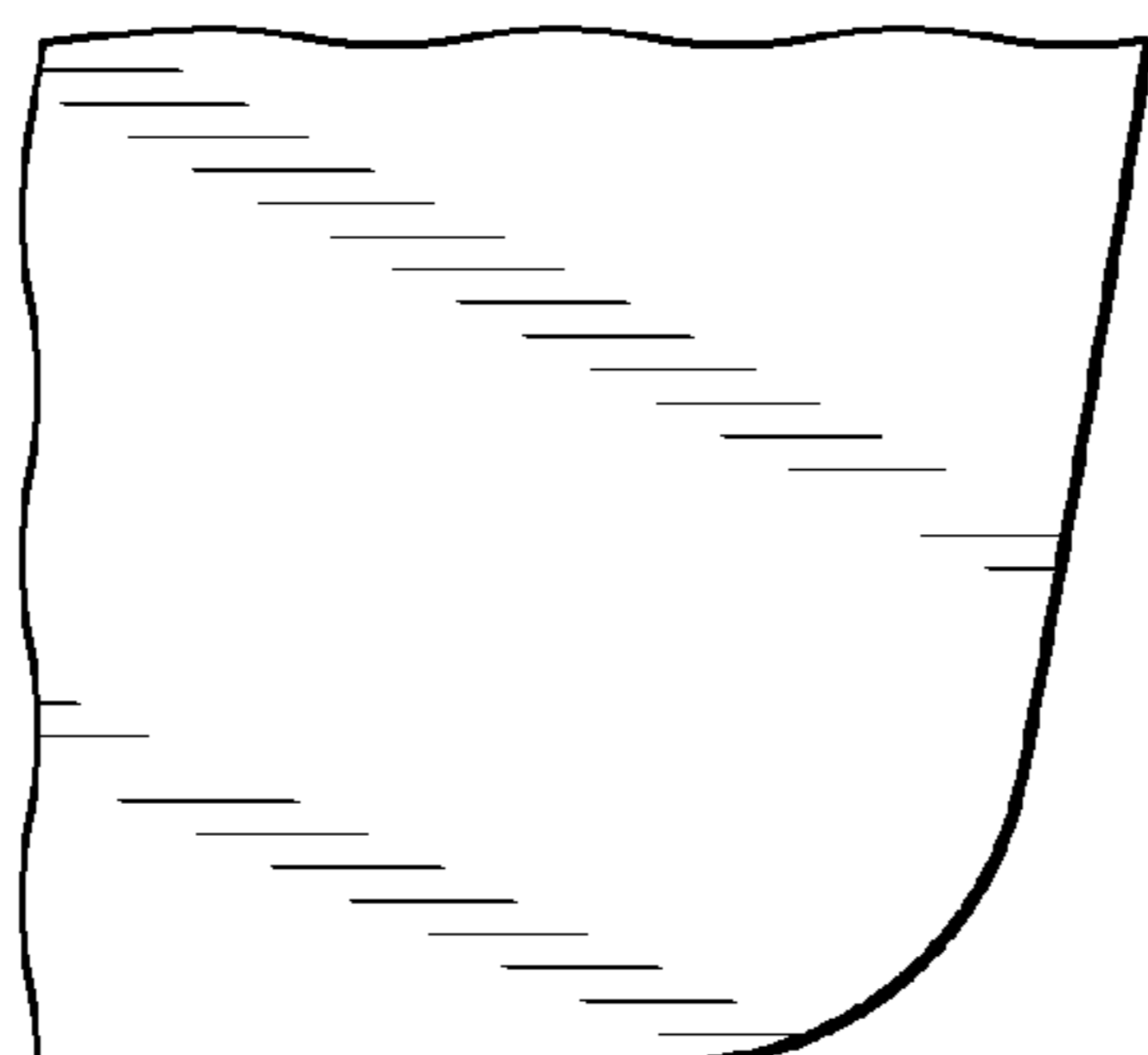

FIG. 7

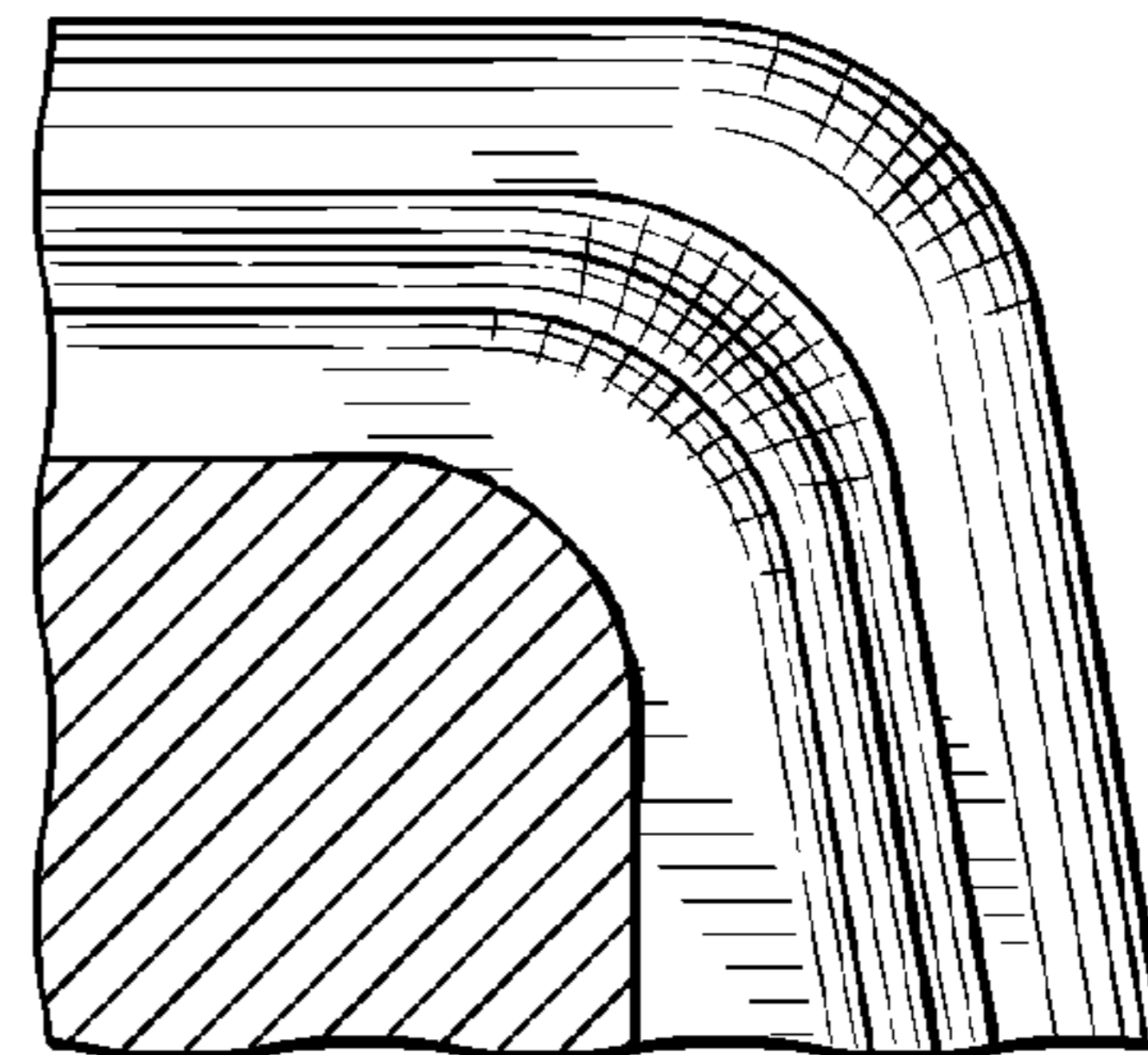

FIG. 8

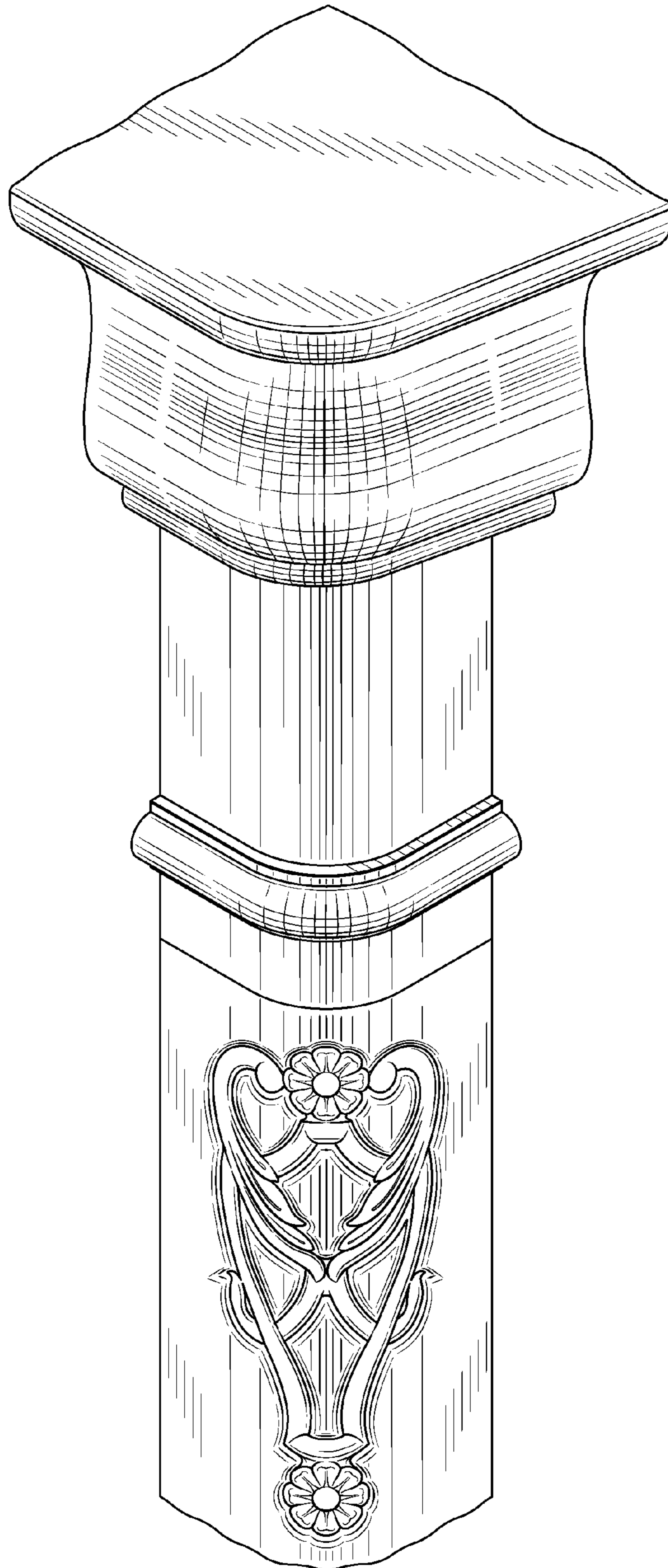

FIG. 9

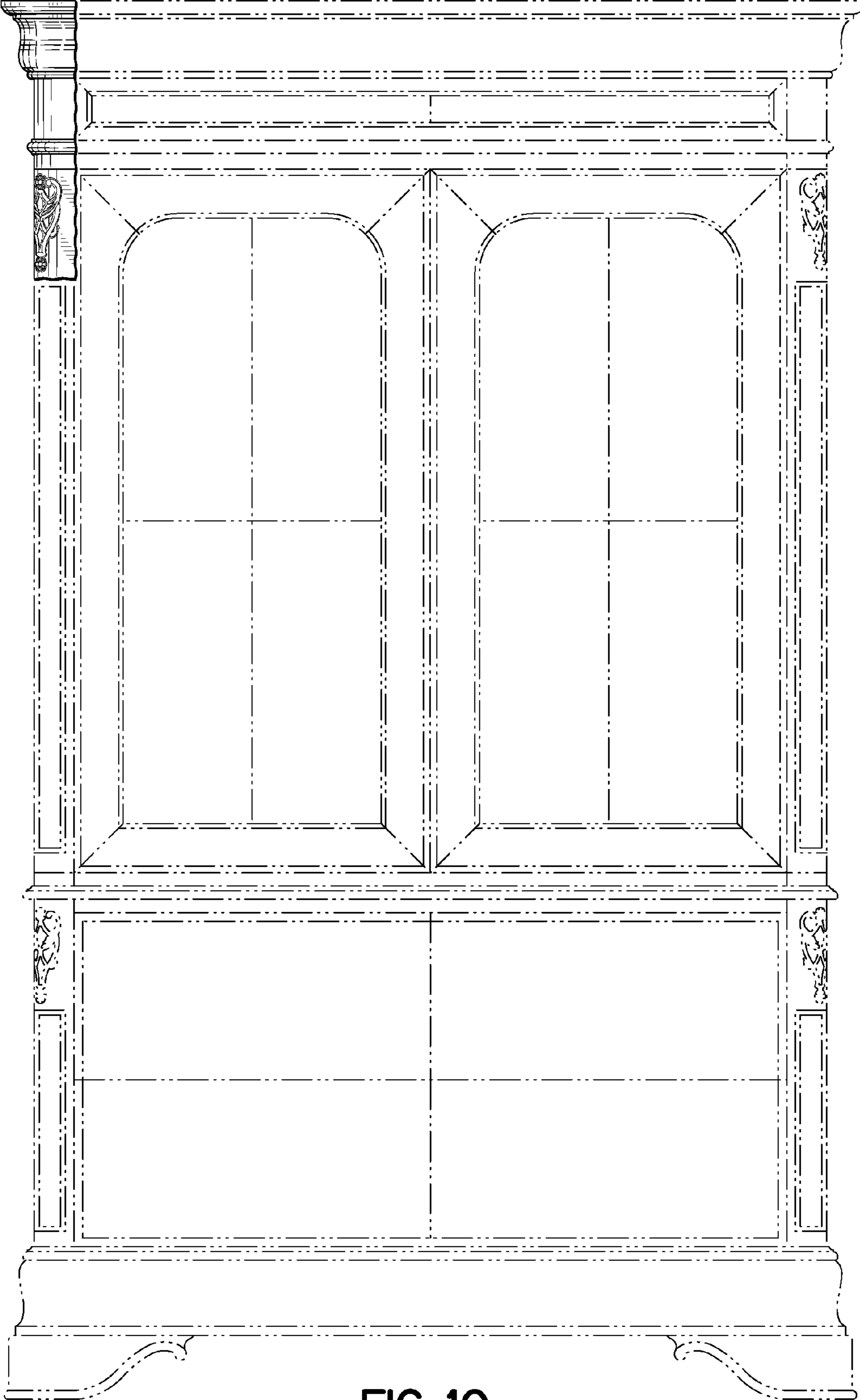

FIG. 10

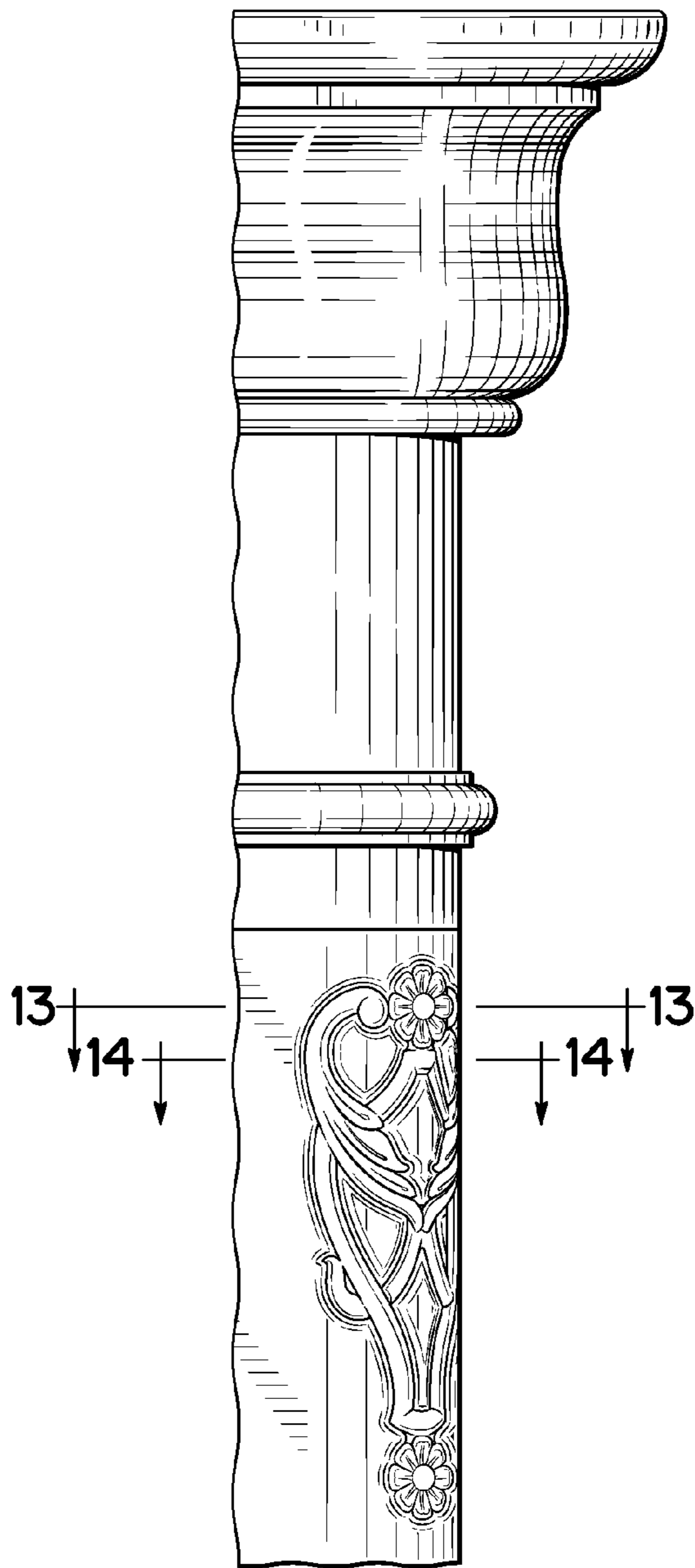

FIG. 11

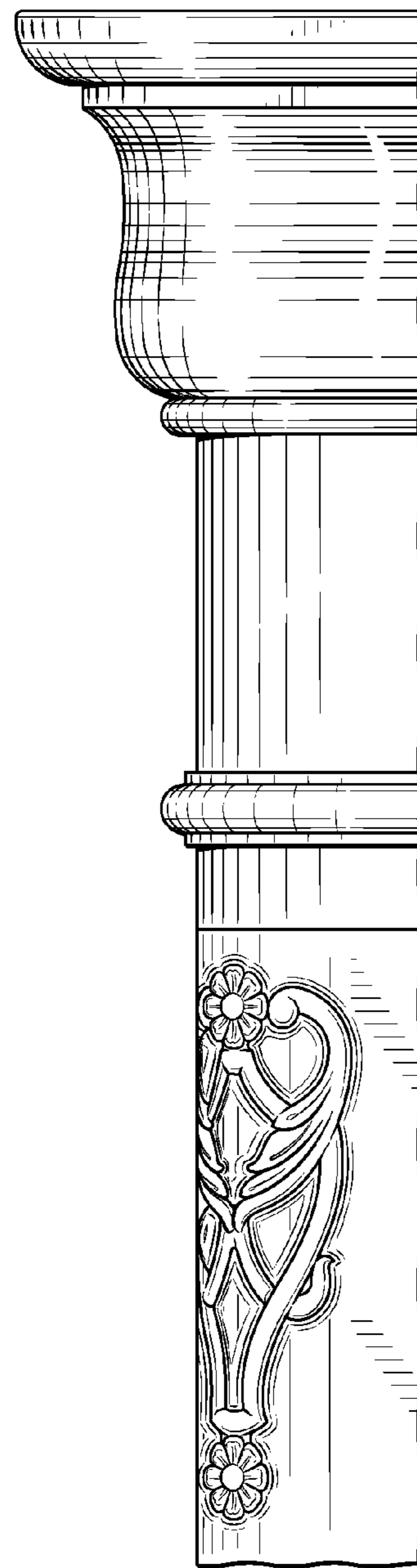

FIG. 12

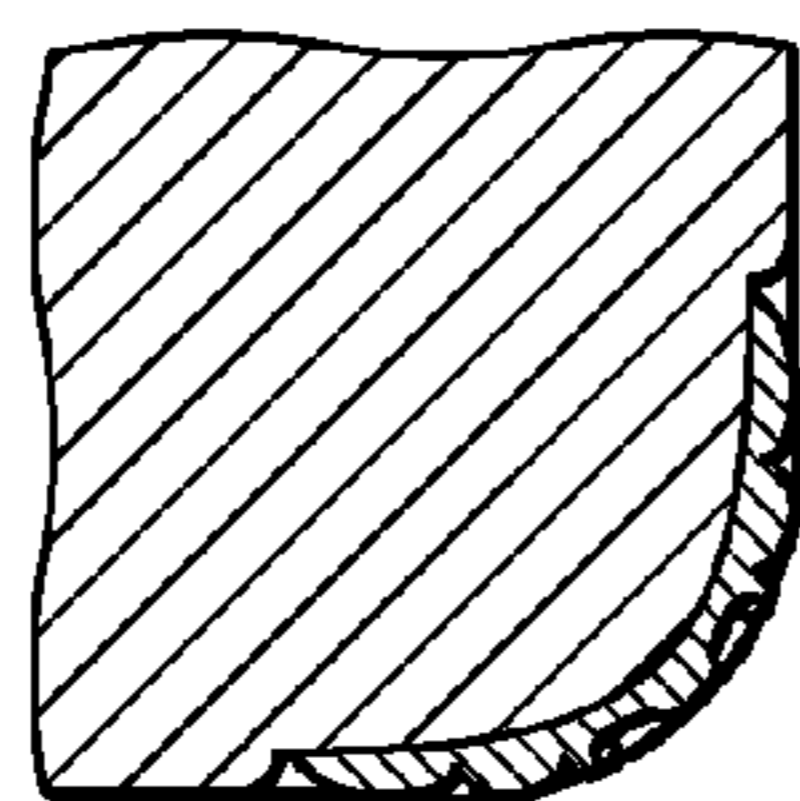

FIG. 13

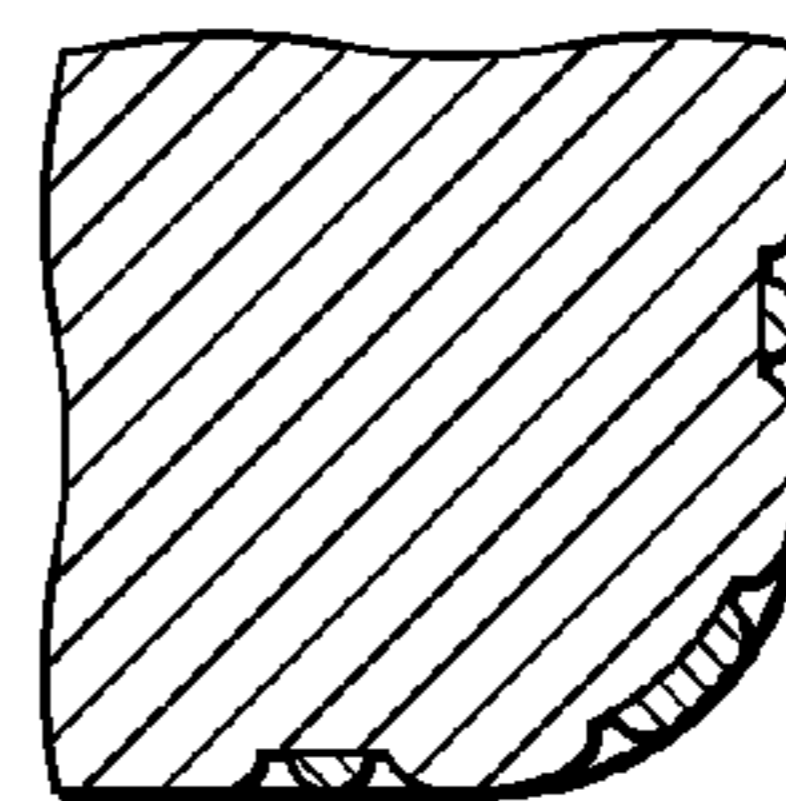

FIG. 14

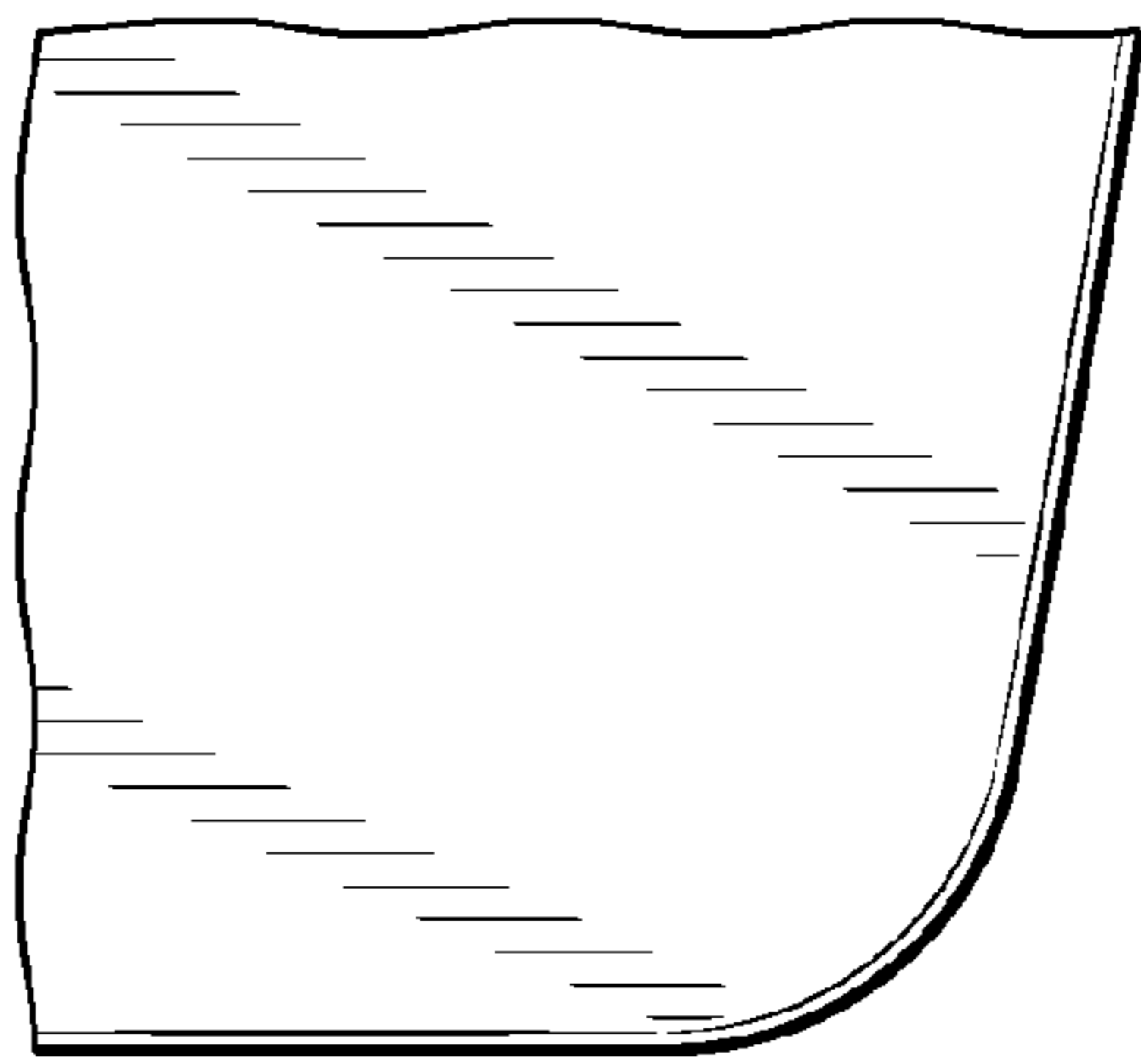

FIG. 15

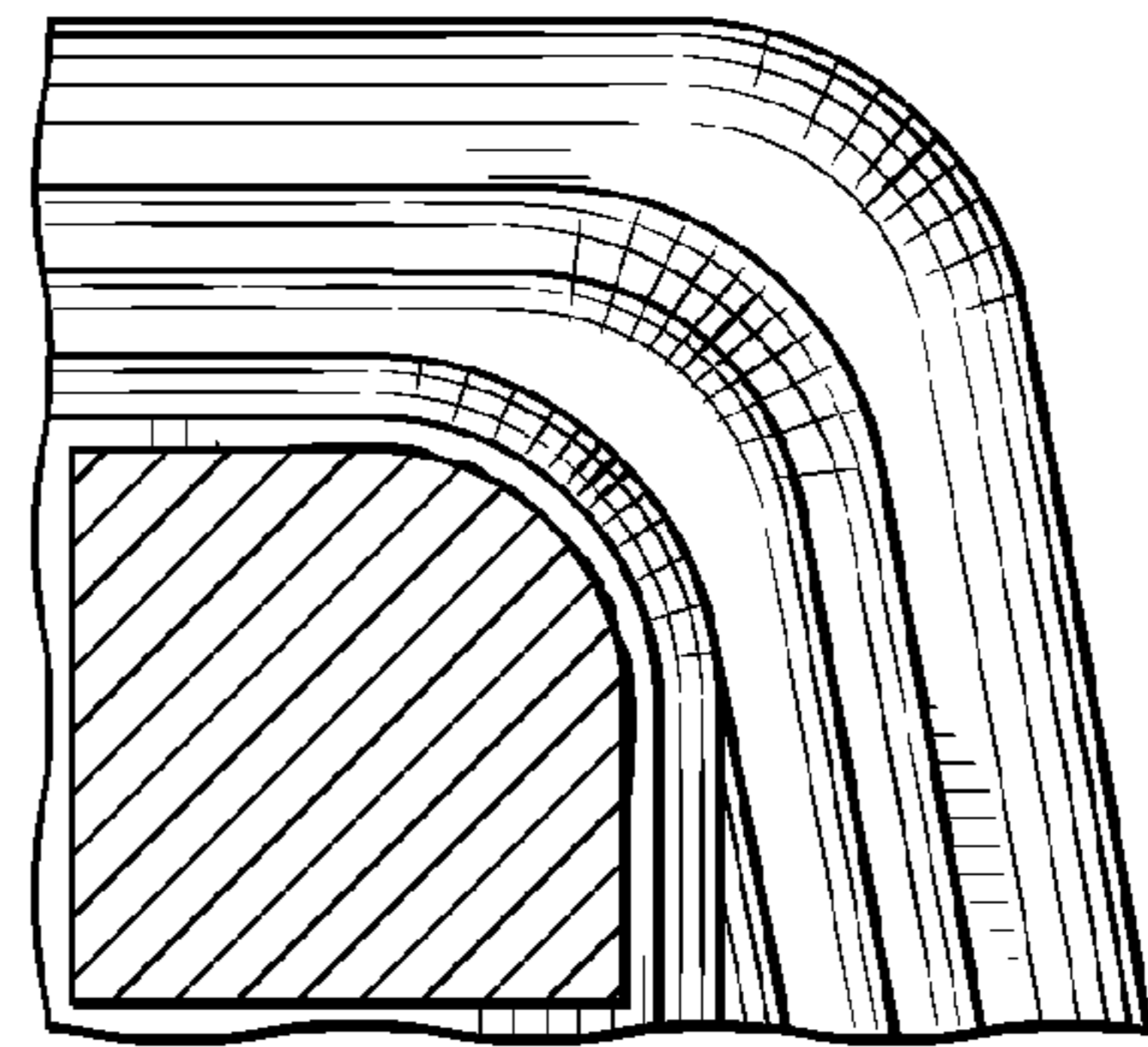

FIG. 16