



US00D601345S

(12) **United States Design Patent**  
**Wales**

(10) **Patent No.:** **US D601,345 S**

(45) **Date of Patent:** **\*\* Oct. 6, 2009**

(54) **GRILL BRUSH ATTACHMENT HAVING SPIRAL BRISTLES AND AUXILIARY SCRAPER**

(76) Inventor: **Michael Wales**, 140 Indian Head Rd.,  
Riverside, CT (US) 06878

(\*\*) Term: **14 Years**

(21) Appl. No.: **29/336,933**

(22) Filed: **May 12, 2009**

(51) **LOC (9) Cl.** ..... **04-01**

(52) **U.S. Cl.** ..... **D4/118; D4/119; D4/131**

(58) **Field of Classification Search** ..... D4/116,  
D4/118, 119, 131, 132; D32/42, 46, 49;  
15/106, 111, 159.1, 160, 206, 236.01, 236.09  
See application file for complete search history.

(56) **References Cited**

**U.S. PATENT DOCUMENTS**

201,688	A *	3/1878	Leiner	.....	15/206
3,629,895	A *	12/1971	Colgan	.....	15/160
4,146,943	A *	4/1979	Wertheimer et al.	.....	15/111
5,373,600	A *	12/1994	Stojanovski et al.	.....	15/111
6,438,784	B1 *	8/2002	Yu	.....	15/106
D468,107	S *	1/2003	Shen	.....	D4/118
D589,705	S *	4/2009	Zemel	.....	D4/119

\* cited by examiner

*Primary Examiner*—Melanie H Tung  
*Assistant Examiner*—Lavone D Tabor  
(74) *Attorney, Agent, or Firm*—St. Onge Steward Johnston & Reens LLC

(57) **CLAIM**

The ornamental design for a grill brush attachment having spiral bristles and auxiliary scraper, as shown and described.

**DESCRIPTION**

FIG. 1 is a rear isometric view of a grill brush attachment having spiral bristles and auxiliary scraper in accordance with the new design;

FIG. 2 is a rear view thereof;

FIG. 3 is a top view thereof;

FIG. 4 is a front view thereof;

FIG. 5 is a bottom view thereof; and,

FIG. 6 is a side view thereof.

The broken lines shown on both sides and the bottom of the grill brush attachment represent the bounds of the claim and all of the other broken lines are understood to illustrate the environment in which the article embodying the design is used. None of the broken lines form part of the claimed design.

**1 Claim, 4 Drawing Sheets**

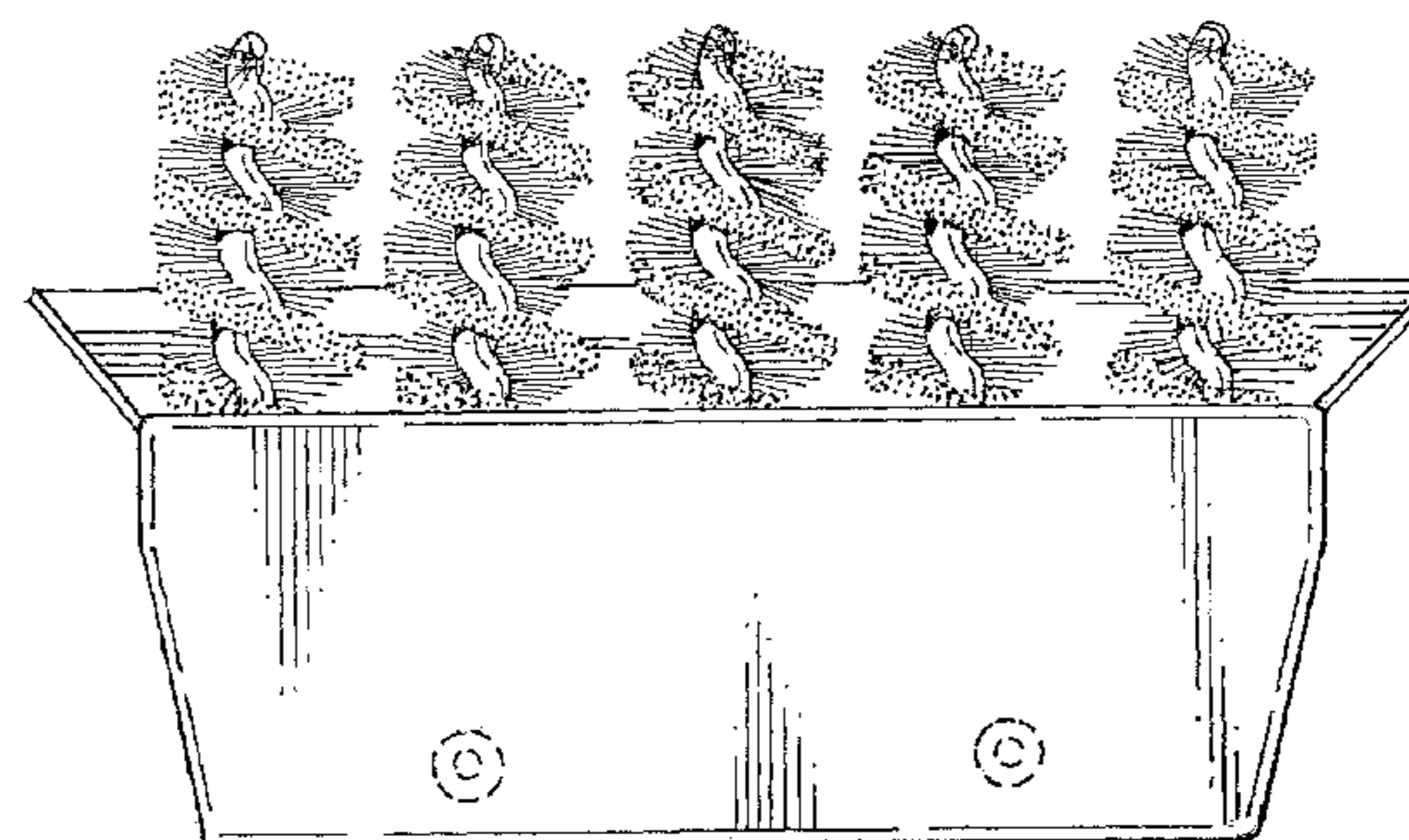
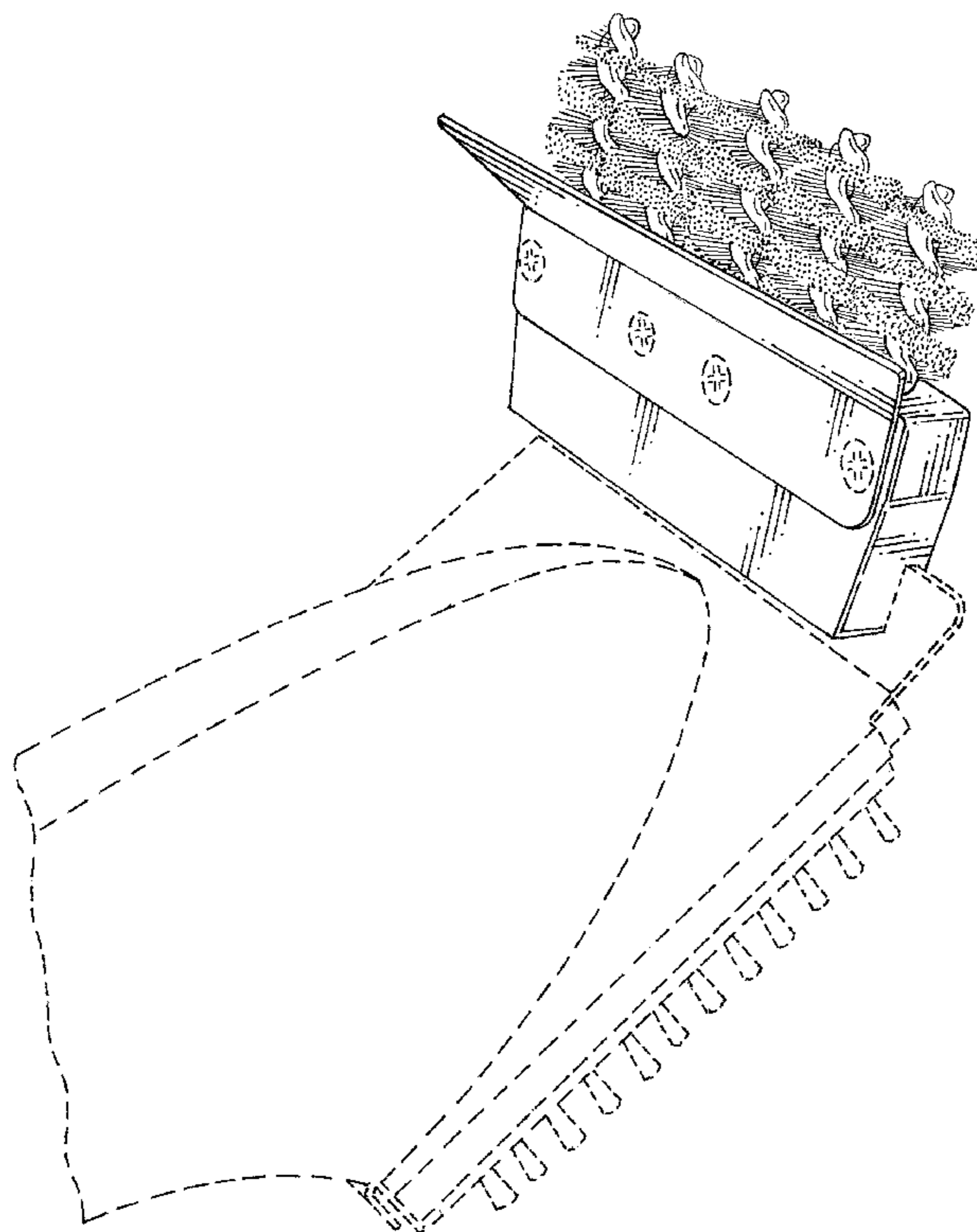

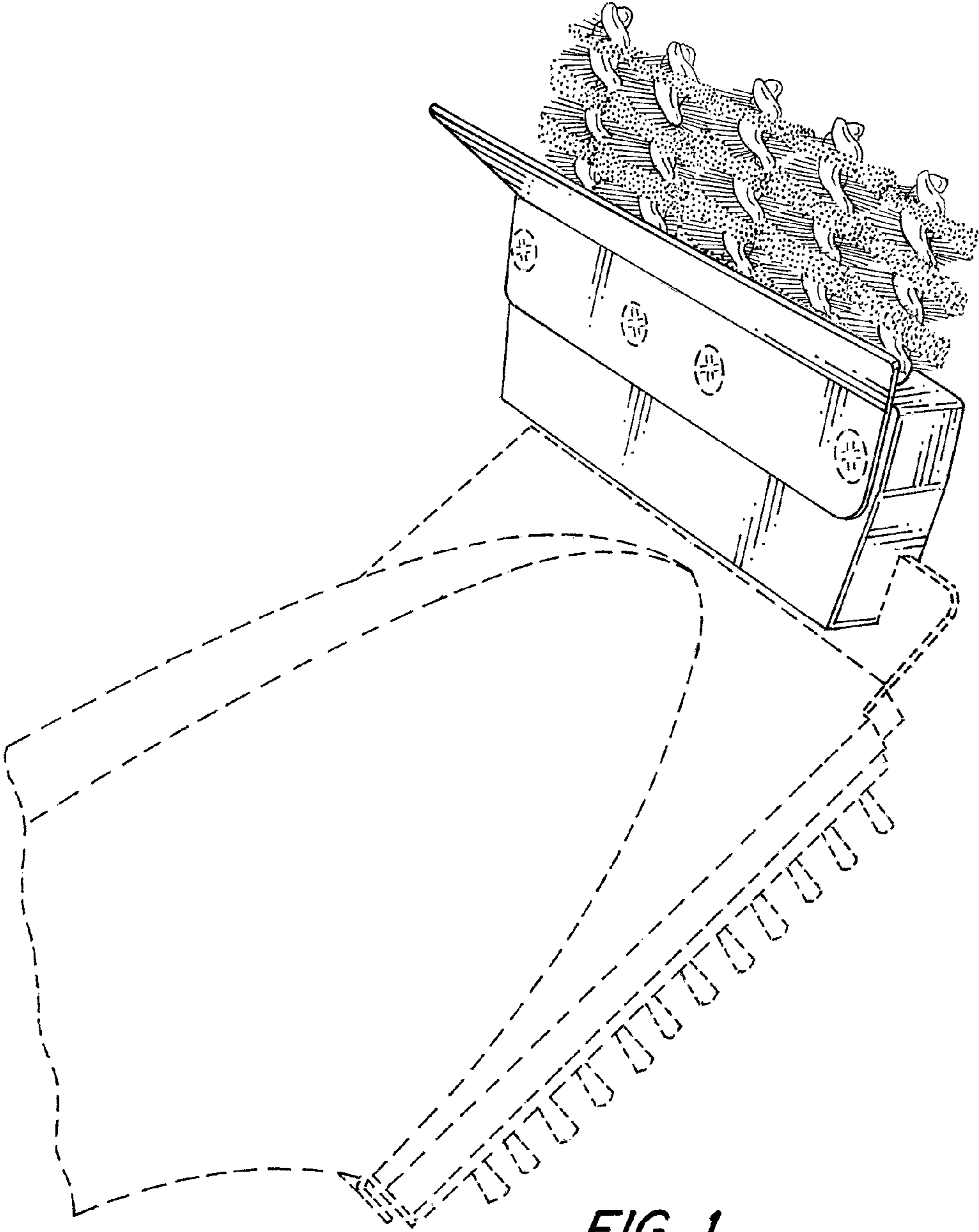
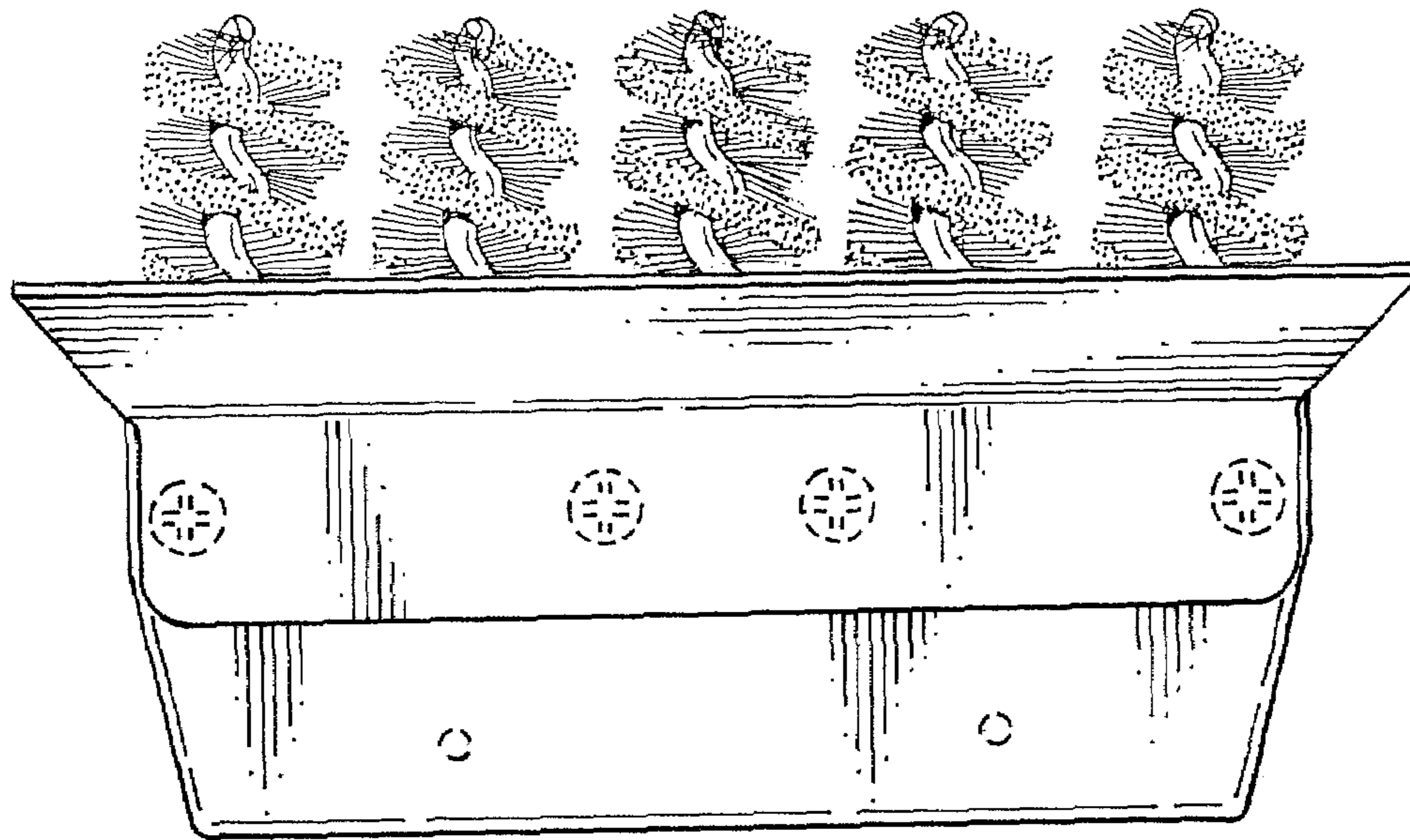
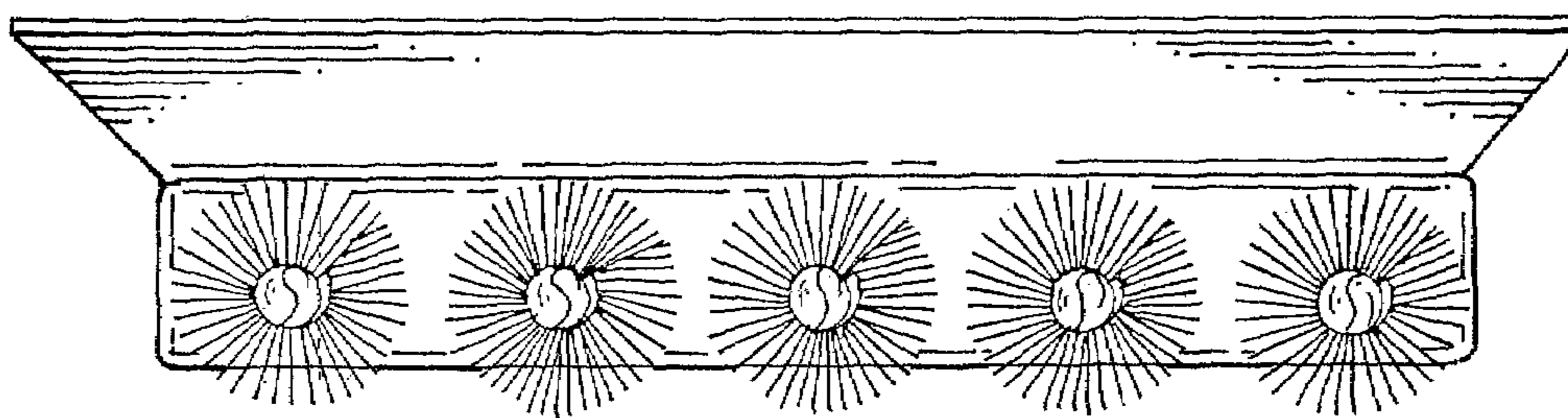

FIG. 1



*FIG. 2*



*FIG. 3*



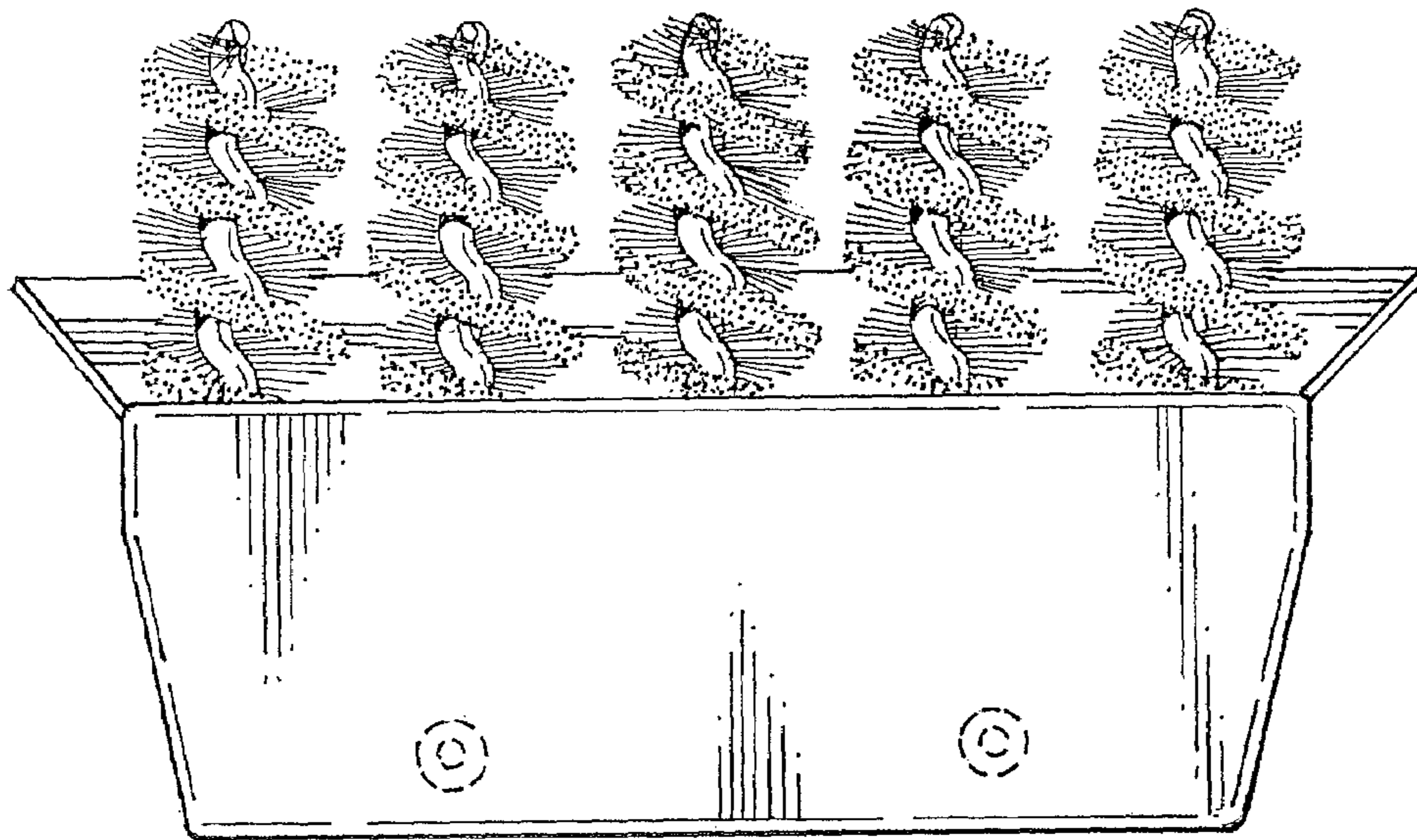

FIG. 4

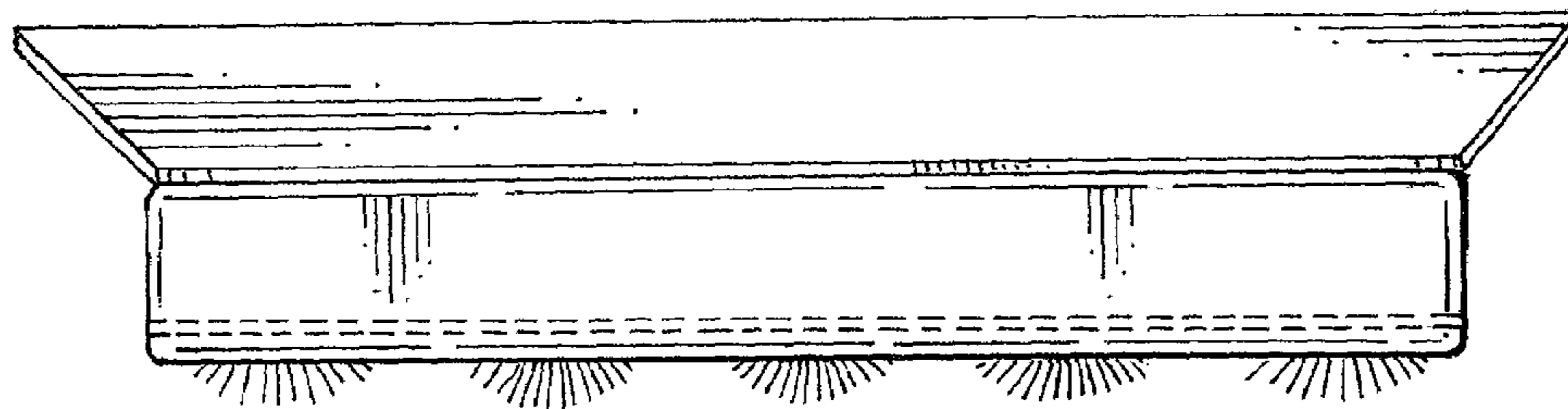
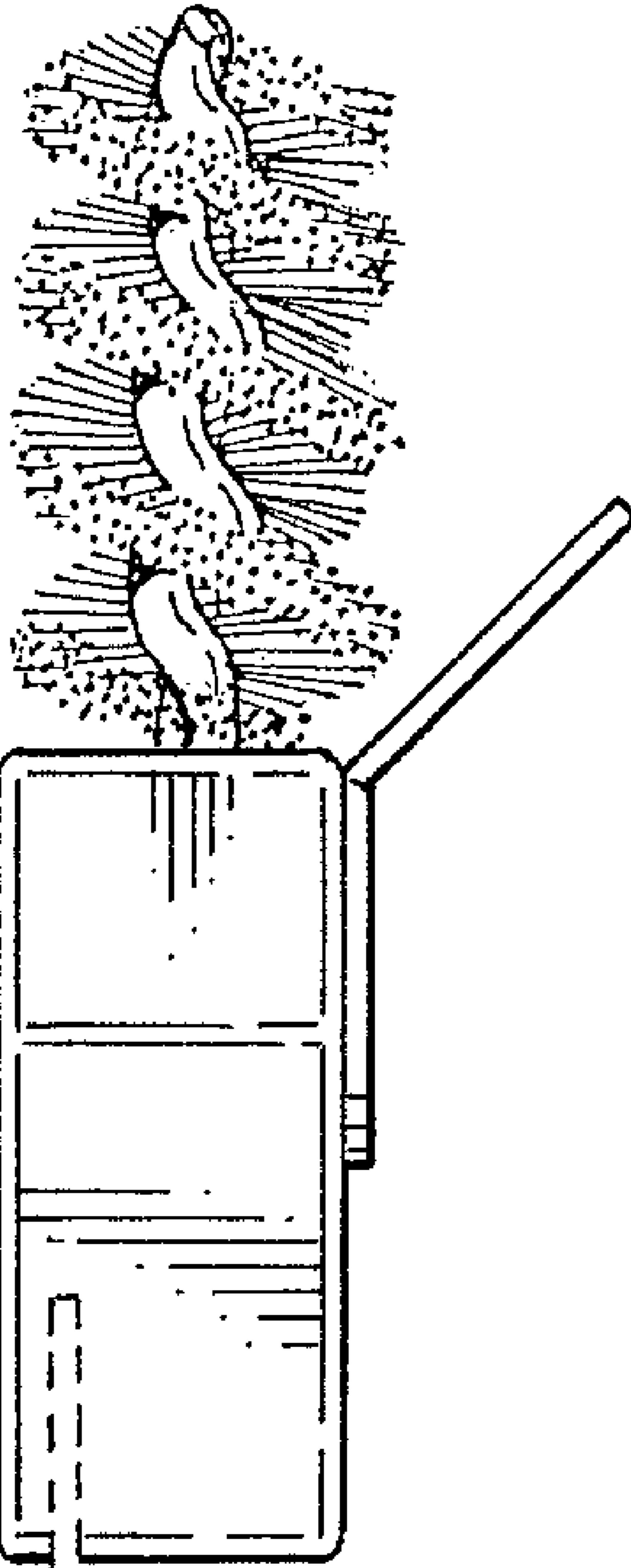

FIG. 5



**FIG. 6**