



US00D601188S

(12) **United States Design Patent**
Grassia et al.

(10) **Patent No.:** **US D601,188 S**

(45) **Date of Patent:** **** Sep. 29, 2009**

(54) **GATE-FLAP PORTFOLIO**

(75) Inventors: **Lauren Grassia**, East Northport, NY
(US); **Juliet Kenney**, New York, NY
(US)

(73) Assignee: **Esselte Corporation**, Melville, NY (US)

(**) Term: **14 Years**

(21) Appl. No.: **29/318,243**

(22) Filed: **May 15, 2008**

(51) **LOC (9) Cl.** **19-04**

(52) **U.S. Cl.** **D19/26**

(58) **Field of Classification Search** D3/301,
D3/289, 287, 285, 284, 276, 267, 206, 268;
D9/417, 423, 424, 430; D19/86, 88, 26,
D19/27; D6/631, 632, 633; 383/4, 10; 224/651,
224/652; 206/320; 190/111, 117, 114, 115
See application file for complete search history.

(56) **References Cited**

U.S. PATENT DOCUMENTS

D45,677 S *	4/1914	Shick	D19/26
1,459,092 A *	6/1923	Etheridge	229/92.5
1,583,867 A *	5/1926	Benedict	229/92.1
RE17,468 E	10/1929	Osborn		
1,733,388 A	10/1929	Piltzer		
1,803,343 A *	5/1931	Muldner, Jr.	206/294
2,165,195 A	4/1939	Sawdon	281/3
2,203,578 A	6/1940	Podmore	46/35
2,222,443 A *	11/1940	Rubins	229/72
2,260,407 A *	10/1941	Schade	40/359
2,283,980 A *	5/1942	Fay	281/16
2,426,503 A *	8/1947	Herbener	150/147
2,452,231 A *	10/1948	Dobie, Jr.	40/359
3,756,468 A *	9/1973	Holmes	229/80
D262,461 S	12/1981	Holson	D19/26
D282,856 S *	3/1986	Daly	D6/626
D295,289 S *	4/1988	Nickow	D19/26
4,738,391 A	4/1988	Wiseman	229/80
D302,698 S *	8/1989	Rexroat et al.	D19/26
D308,887 S *	6/1990	Wyant	D19/26

D312,275 S *	11/1990	Wyant	D19/26
D316,781 S *	5/1991	Hiltunen	D3/247
5,025,978 A *	6/1991	Pacione	229/67.1
D323,348 S *	1/1992	Tooker	D19/26
5,114,009 A	5/1992	Johnston	206/425
D337,784 S *	7/1993	Wyant	D19/26
5,255,779 A *	10/1993	Koenig, III	206/232
5,285,952 A *	2/1994	Ho	229/67.4
5,341,982 A *	8/1994	Syers	229/67.1

(Continued)

Primary Examiner—Cathron C Brooks

Assistant Examiner—Austin Murphy

(74) *Attorney, Agent, or Firm*—Dorsey & Whitney LLP

(57) **CLAIM**

The ornamental design for a gate-flap portfolio, as shown and described.

DESCRIPTION

FIG. 1 is a front view of a first embodiment of a gate-flap portfolio in a closed position showing my new design;

FIG. 2 is a front view of the gate-flap portfolio of FIG. 1 in an open position, displaying upper and lower internal pockets;

FIG. 3 is a rear view of the gate-flap portfolio thereof;

FIG. 4 is a front, top perspective view of the gate-flap portfolio of FIG. 1 in a partially open position;

FIG. 5 is a front view of a second embodiment of a gate-flap portfolio in a closed position showing my new design;

FIG. 6 is a front view of the gate-flap portfolio of FIG. 5 in an open position, displaying upper and lower internal pockets;

FIG. 7 is a rear view of the gate-flap portfolio thereof; and,

FIG. 8 is a front, top perspective view of the gate-flap portfolio of FIG. 5 in a partially open position.

The card holding slots shown in broken lines in FIGS. 2, 4, 6, and 8 represent portions of the portfolio that form no part of the claimed design.

1 Claim, 7 Drawing Sheets

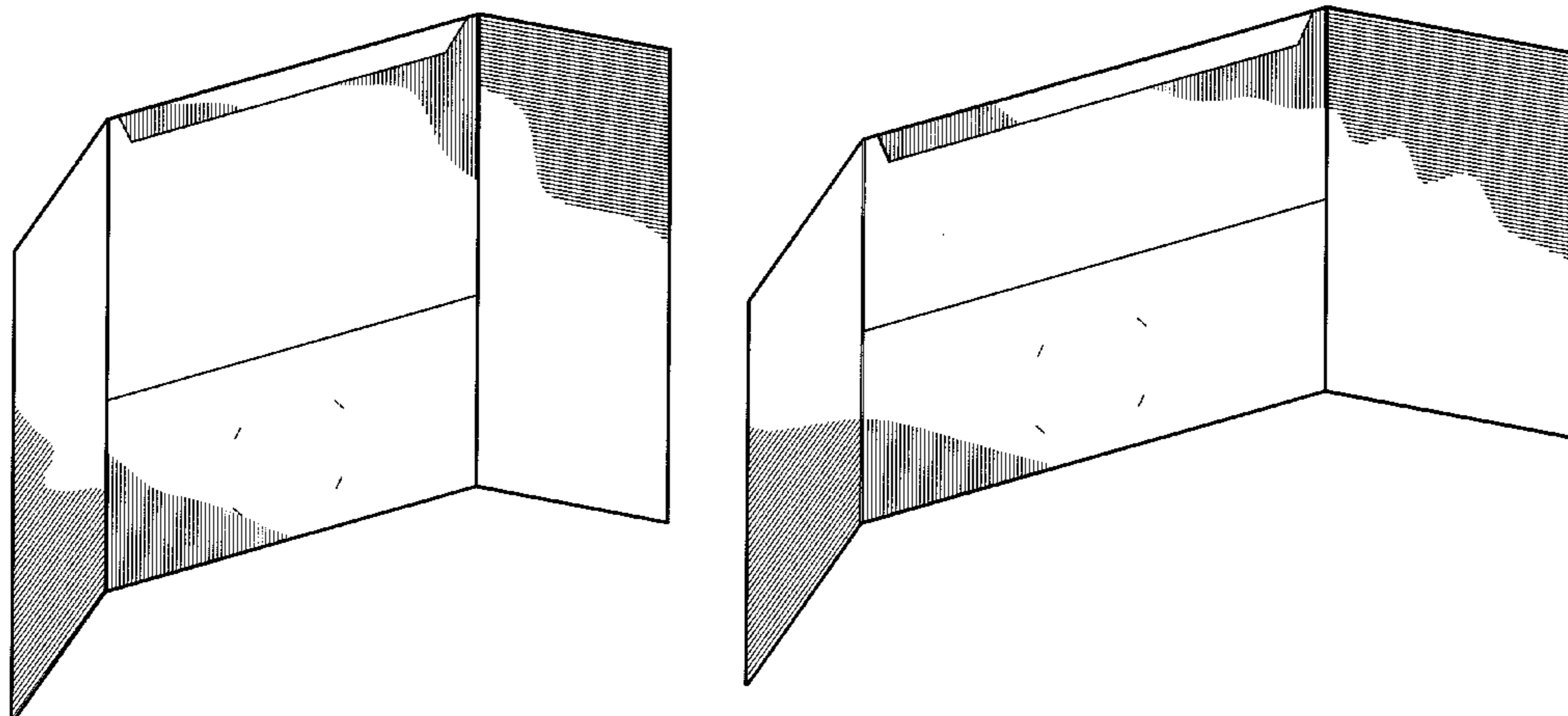

US D601,188 S

Page 2

U.S. PATENT DOCUMENTS

5,447,334	A *	9/1995	Hartsock	281/45	6,485,060	B2 *	11/2002	Nada et al.	281/45
5,492,268	A *	2/1996	Biddle et al.	229/67.1	6,536,803	B2 *	3/2003	Masson	281/33
5,598,969	A *	2/1997	Ong	229/67.1	D521,553	S *	5/2006	Sterman	D19/2
5,797,630	A	8/1998	Conley, Jr.	281/15.1	D523,474	S *	6/2006	Hayes-Roby	D19/26
5,882,038	A *	3/1999	Ong	281/31	7,360,329	B2 *	4/2008	Bourgoin et al.	40/359
6,108,953	A *	8/2000	Hall	40/359	2005/0070410	A1 *	3/2005	Cordes	493/128
6,241,285	B1 *	6/2001	Duhr-Kravitz et al.	281/29	2007/0029779	A1 *	2/2007	Silvers et al.	281/29
6,244,627	B1 *	6/2001	Wolff et al.	281/29	2007/0085326	A1 *	4/2007	Fu	281/21.1
						2007/0228118	A1 *	10/2007	Makofsky	229/67.1

* cited by examiner

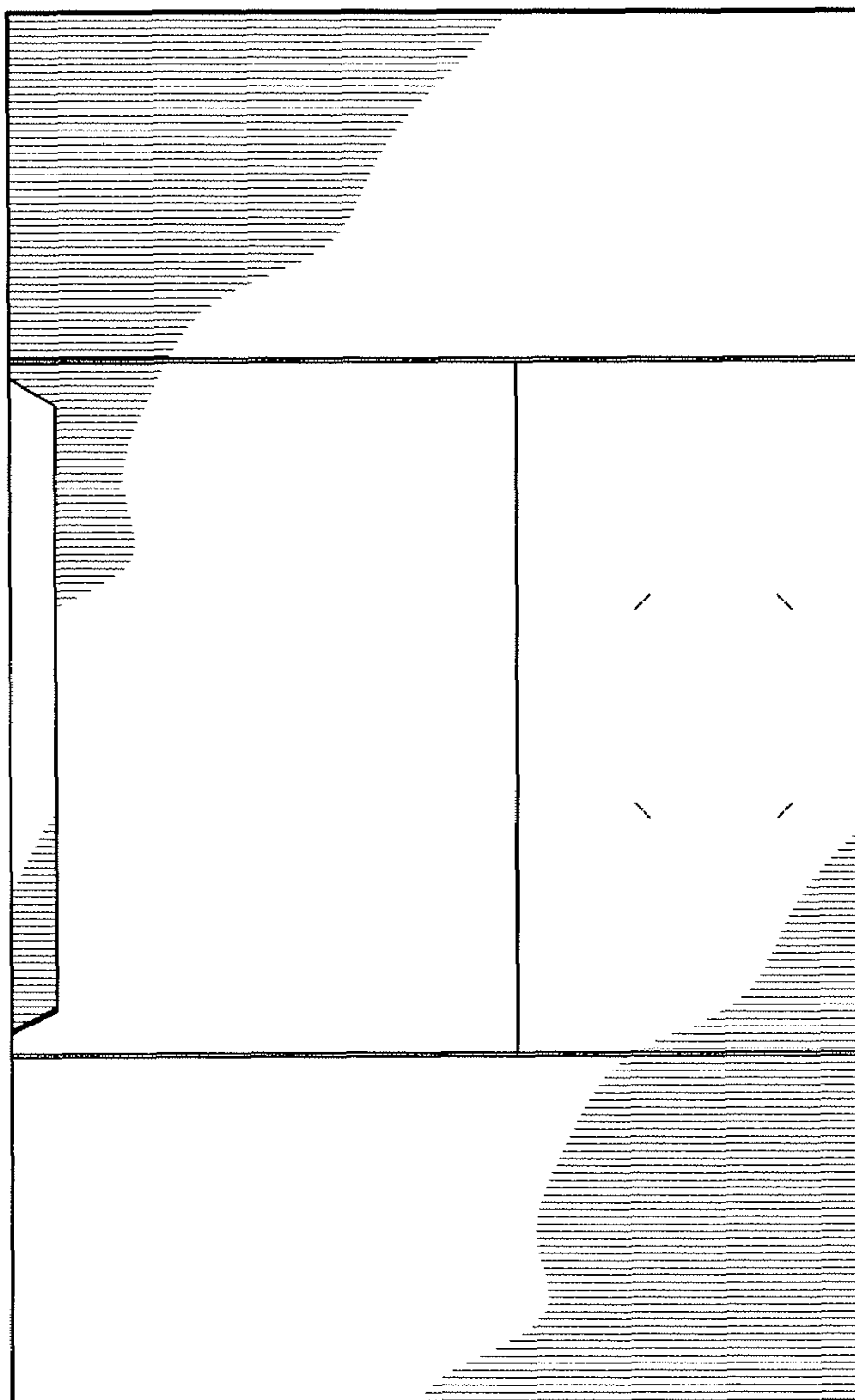

FIG. 2

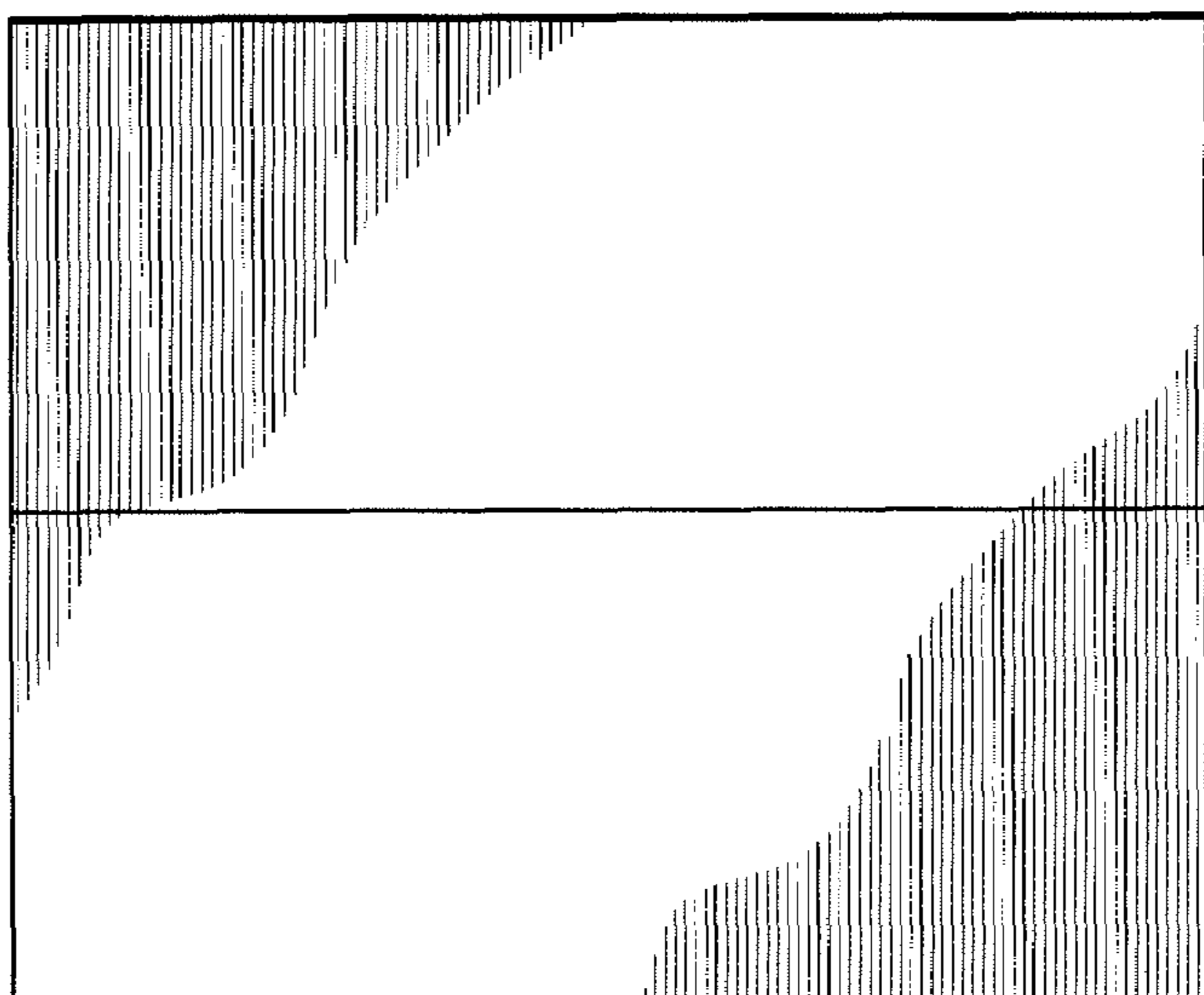

FIG. 1

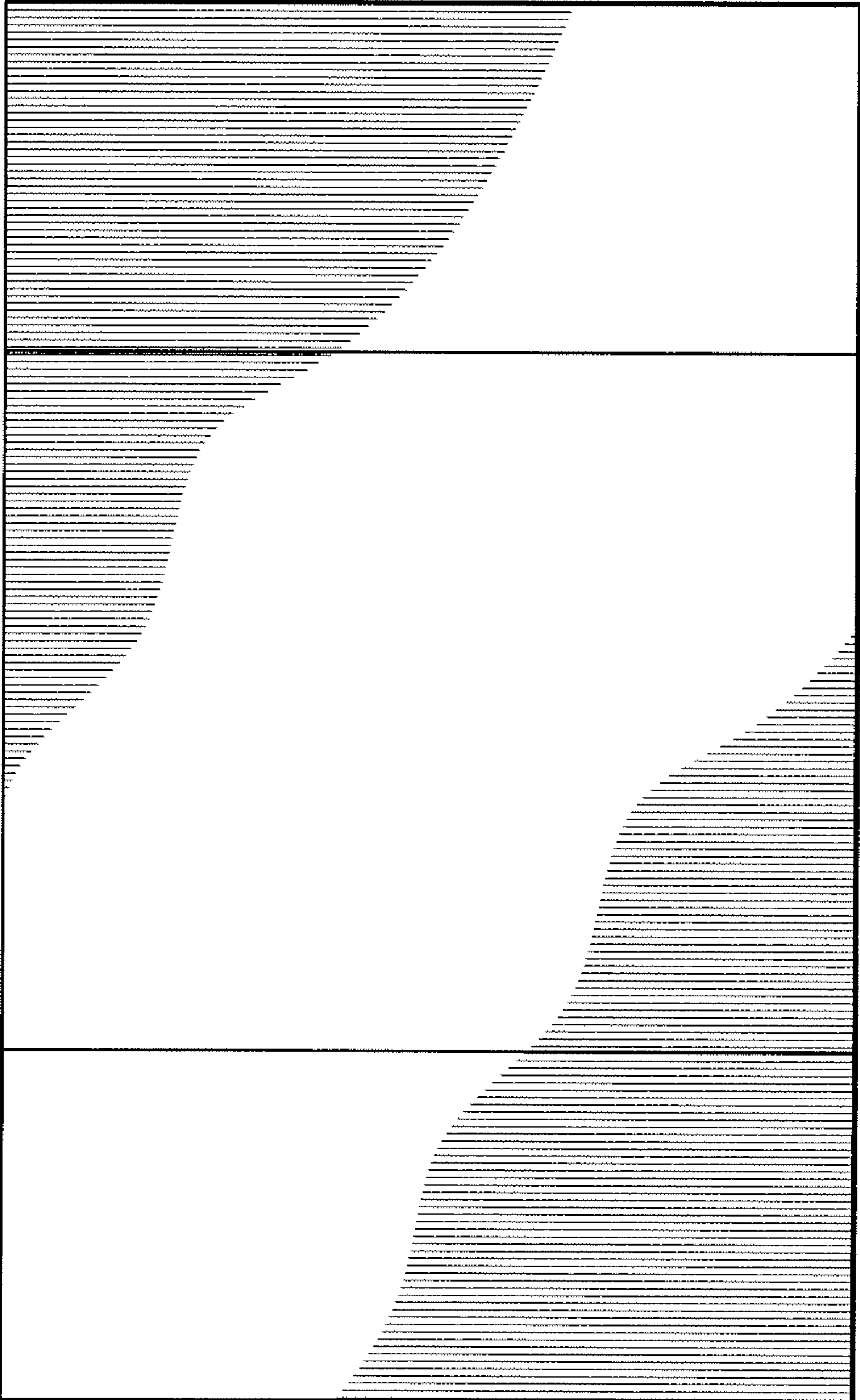

FIG. 3

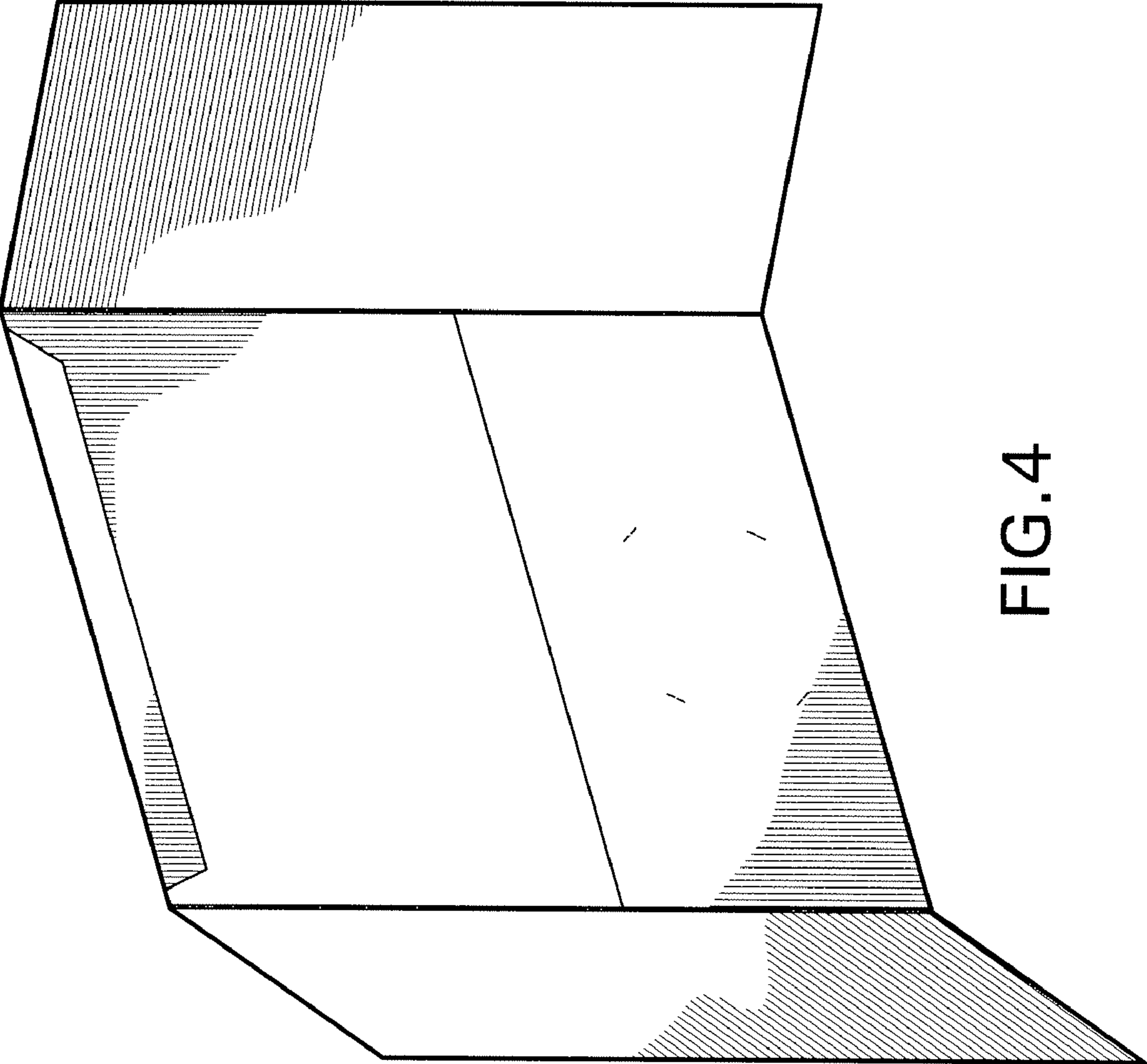

FIG. 4

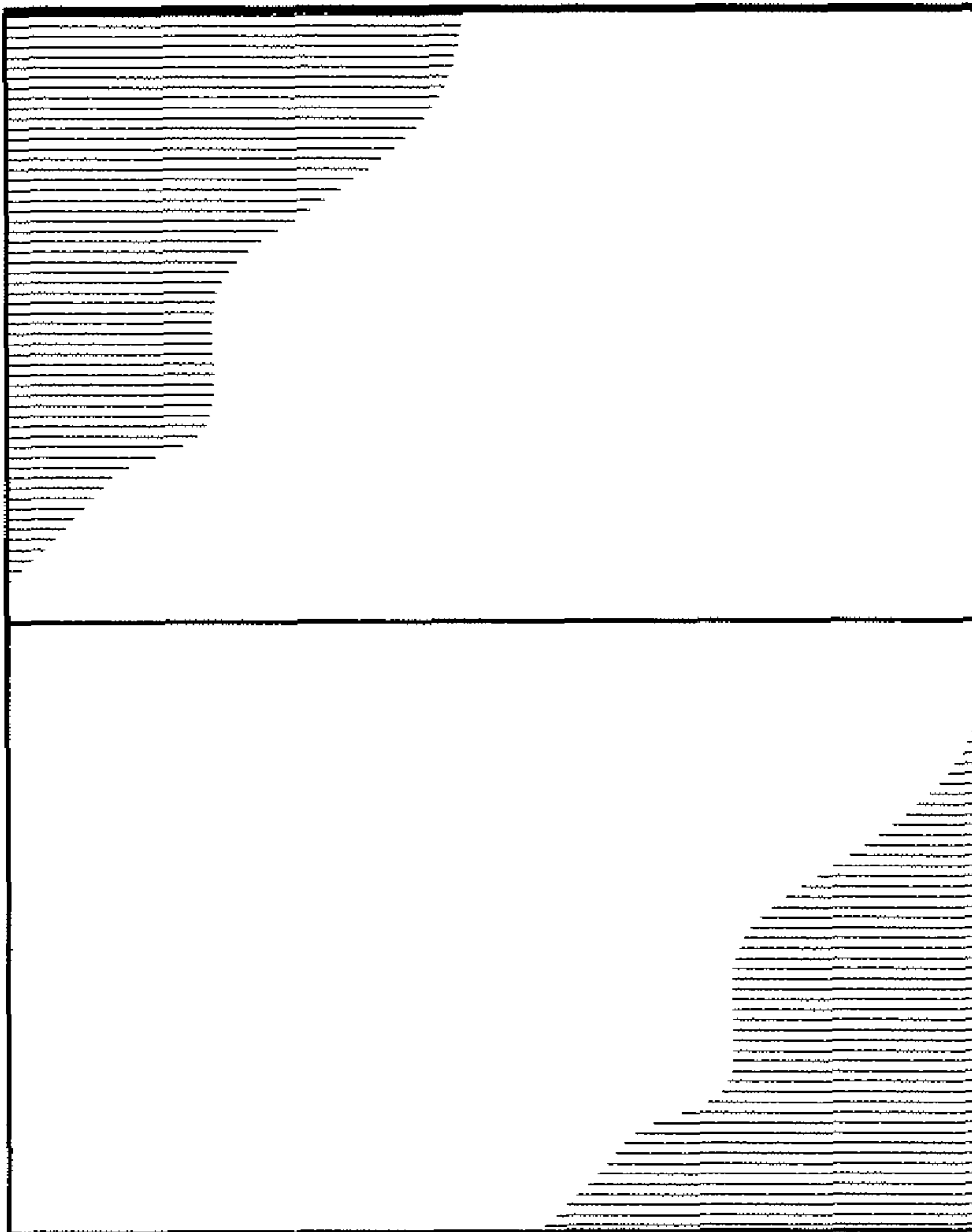

FIG. 5

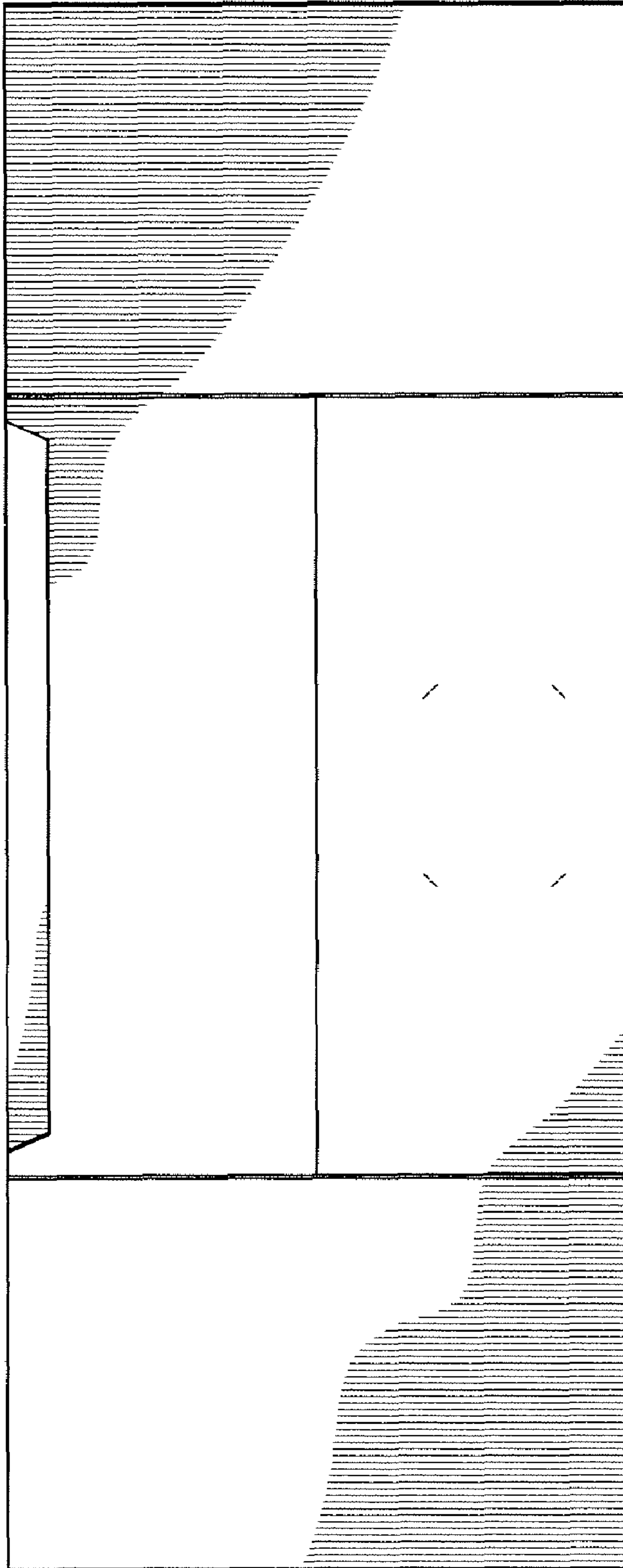

FIG. 6



FIG. 7

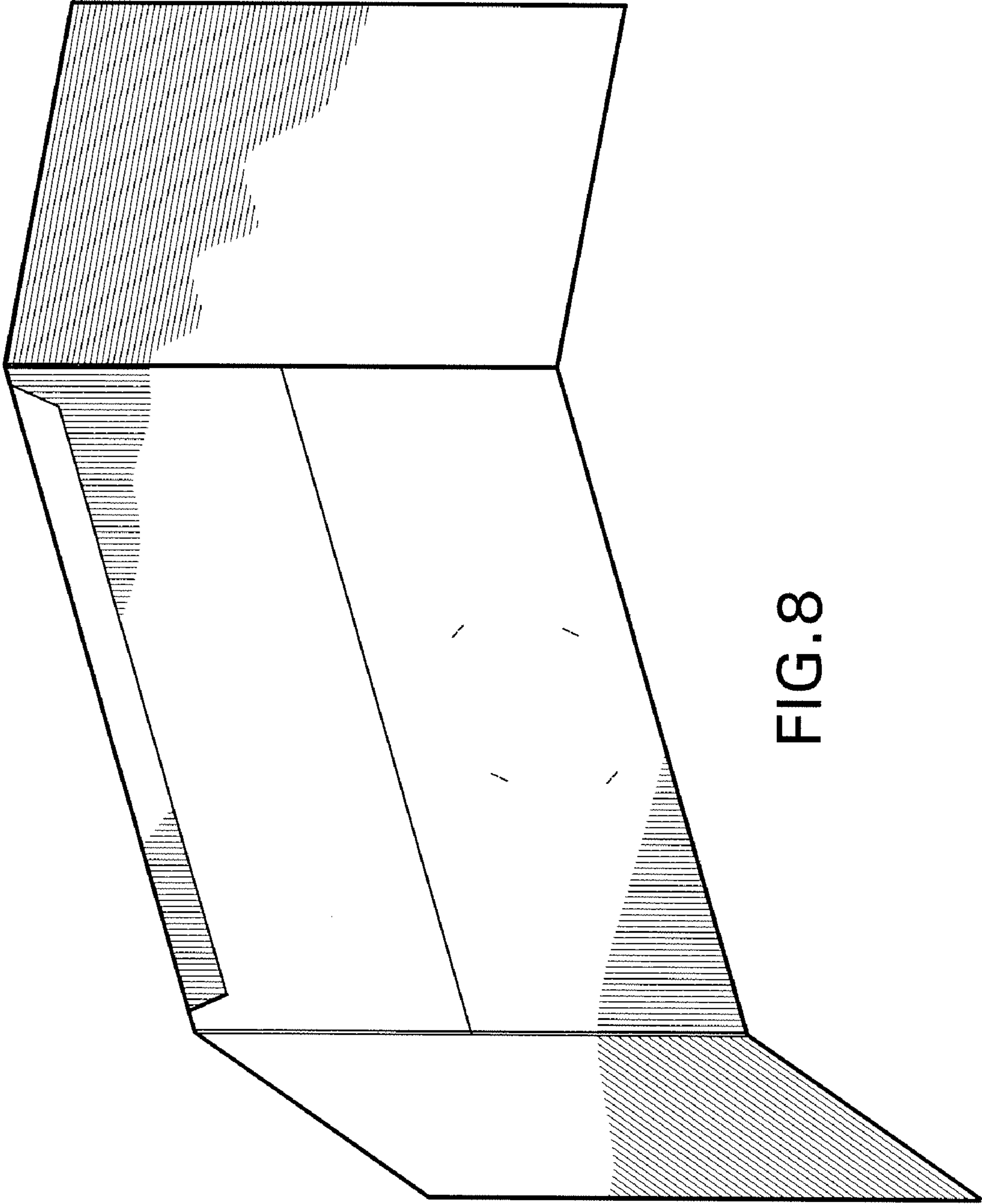

FIG. 8