



US00D601042S

(12) **United States Design Patent**  
**Bodino et al.**

(10) **Patent No.:** **US D601,042 S**

(45) **Date of Patent:** **\*\* Sep. 29, 2009**

(54) **WATCHCASE**

(75) Inventors: **Giampiero Bodino**, Milan (IT); **Guy Bove**, Geneva (CH); **Lukas Gopp**, Nyon (CH)

(73) Assignee: **Ralph Lauren Watch and Jewelry Company Sarl**, Vernier (CH)

(\*\*) Term: **14 Years**

(21) Appl. No.: **29/333,119**

(22) Filed: **Mar. 3, 2009**

(30) **Foreign Application Priority Data**

Sep. 3, 2008 (WO) ..... DM/070 716

(51) **LOC (9) Cl.** ..... **10-02**

(52) **U.S. Cl.** ..... **D10/38**

(58) **Field of Classification Search** ..... D10/30-39;  
368/276, 281, 282, 285

See application file for complete search history.

(56) **References Cited**

**U.S. PATENT DOCUMENTS**

D114,788 S \* 5/1939 Freedman ..... D10/33

2,229,978 A \* 1/1941 Kolberg ..... 224/152

D149,039 S *	3/1948	Barre	.....	D10/32
D268,485 S *	4/1983	Claude	.....	D10/38
D310,331 S *	9/1990	Ratajski	.....	D10/32
D310,337 S *	9/1990	Ratajski	.....	D10/39
D382,214 S *	8/1997	Liao	.....	D10/32
D419,078 S *	1/2000	Bonnett	.....	D10/30
D453,904 S *	2/2002	Terashima	.....	D10/30
D520,381 S *	5/2006	Vigneron	.....	D10/32

\* cited by examiner

*Primary Examiner*—Lucy Lieberman

(74) *Attorney, Agent, or Firm*—Young & Thompson

(57) **CLAIM**

The ornamental design for a watchcase, as shown.

**DESCRIPTION**

FIG. 1 is a top plan view of a watchcase showing our new design;

FIG. 2 is a bottom plan view thereof;

FIG. 3 is a view thereof from the top of FIG. 2;

FIG. 4 is a view thereof from the bottom of FIG. 1;

FIG. 5 is a view thereof from the left of FIG. 4;

FIG. 6 is a view thereof from the right of FIG. 4; and,

FIG. 7 is a top and side perspective view thereof.

**1 Claim, 3 Drawing Sheets**

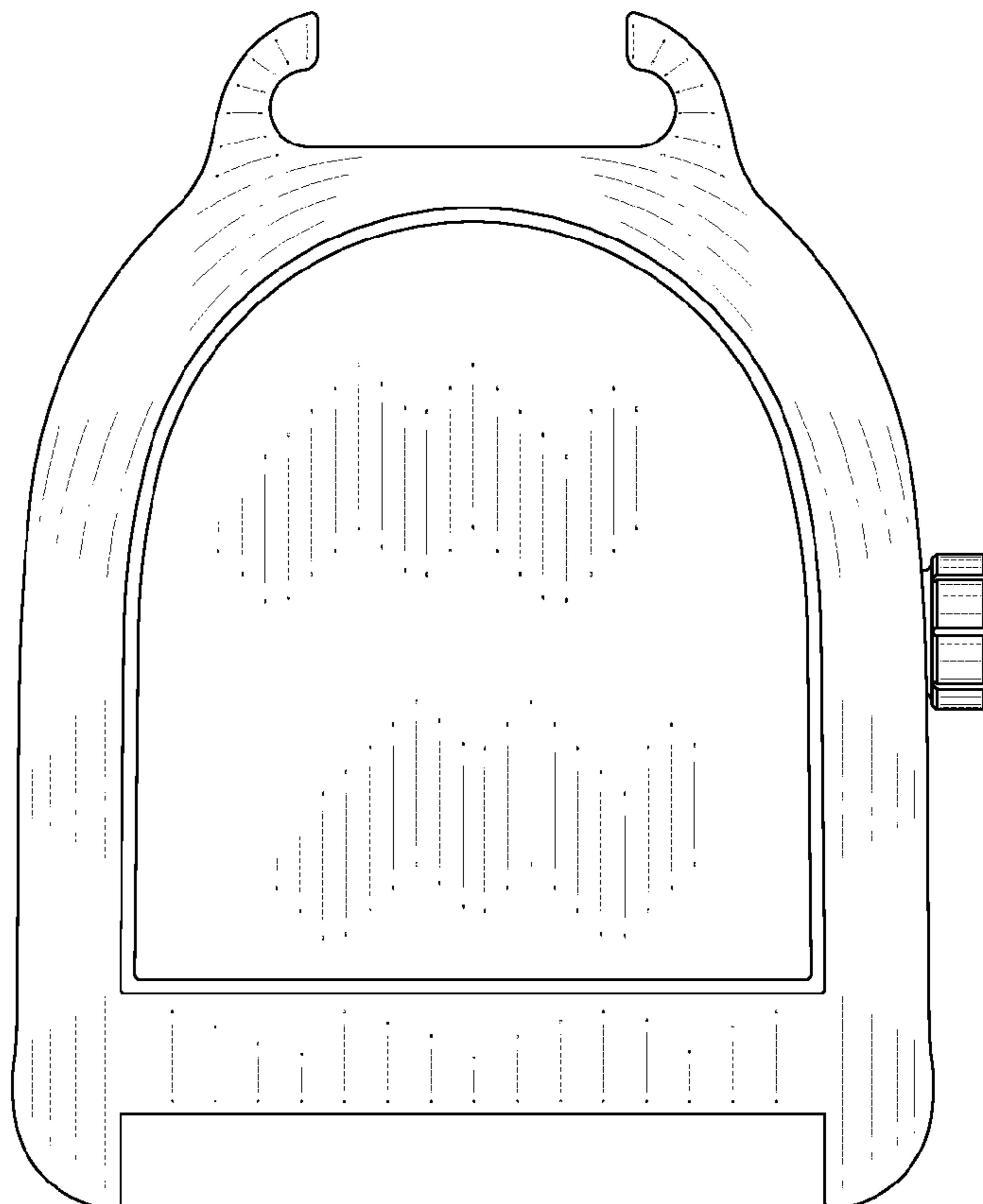

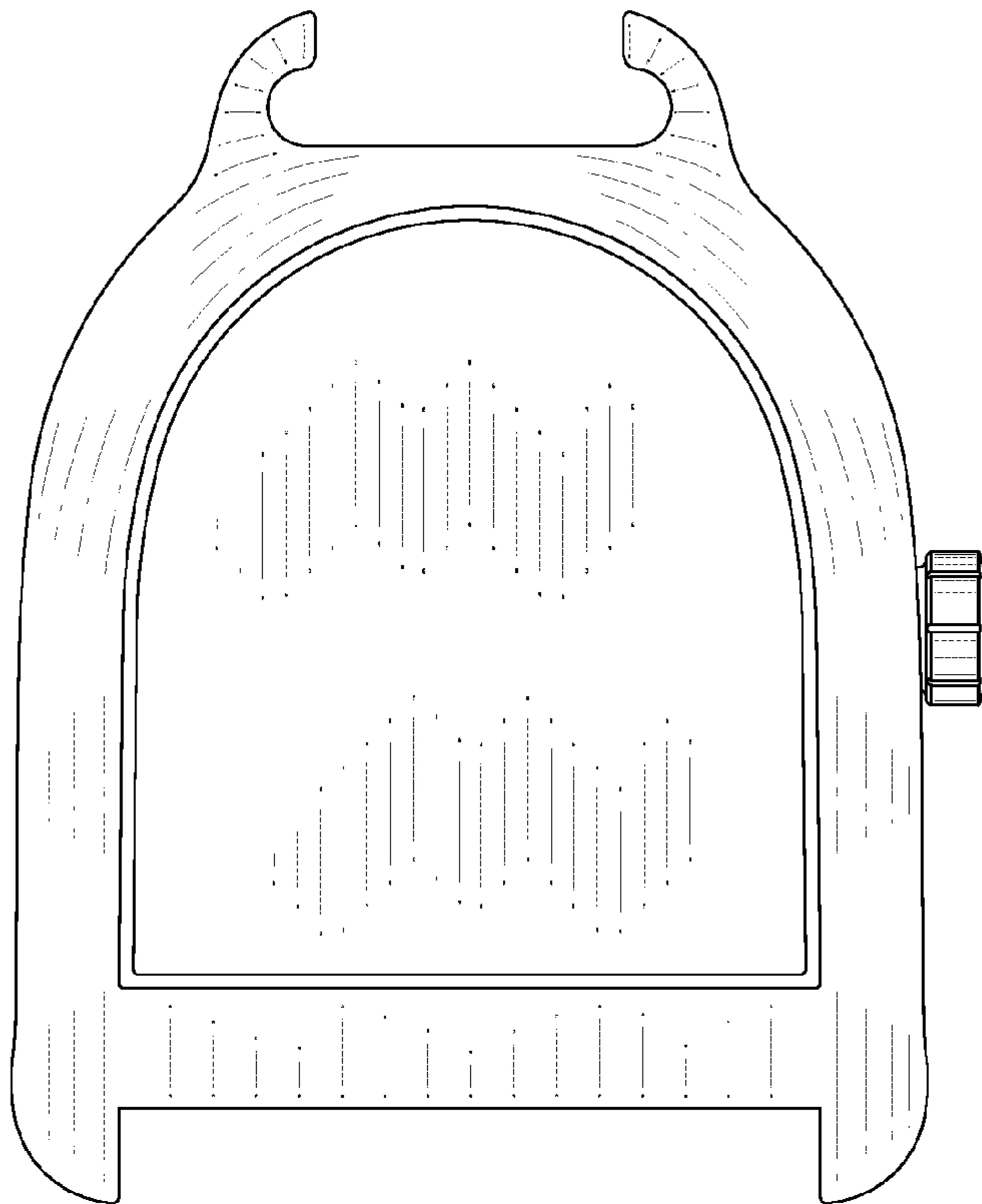

Fig.1

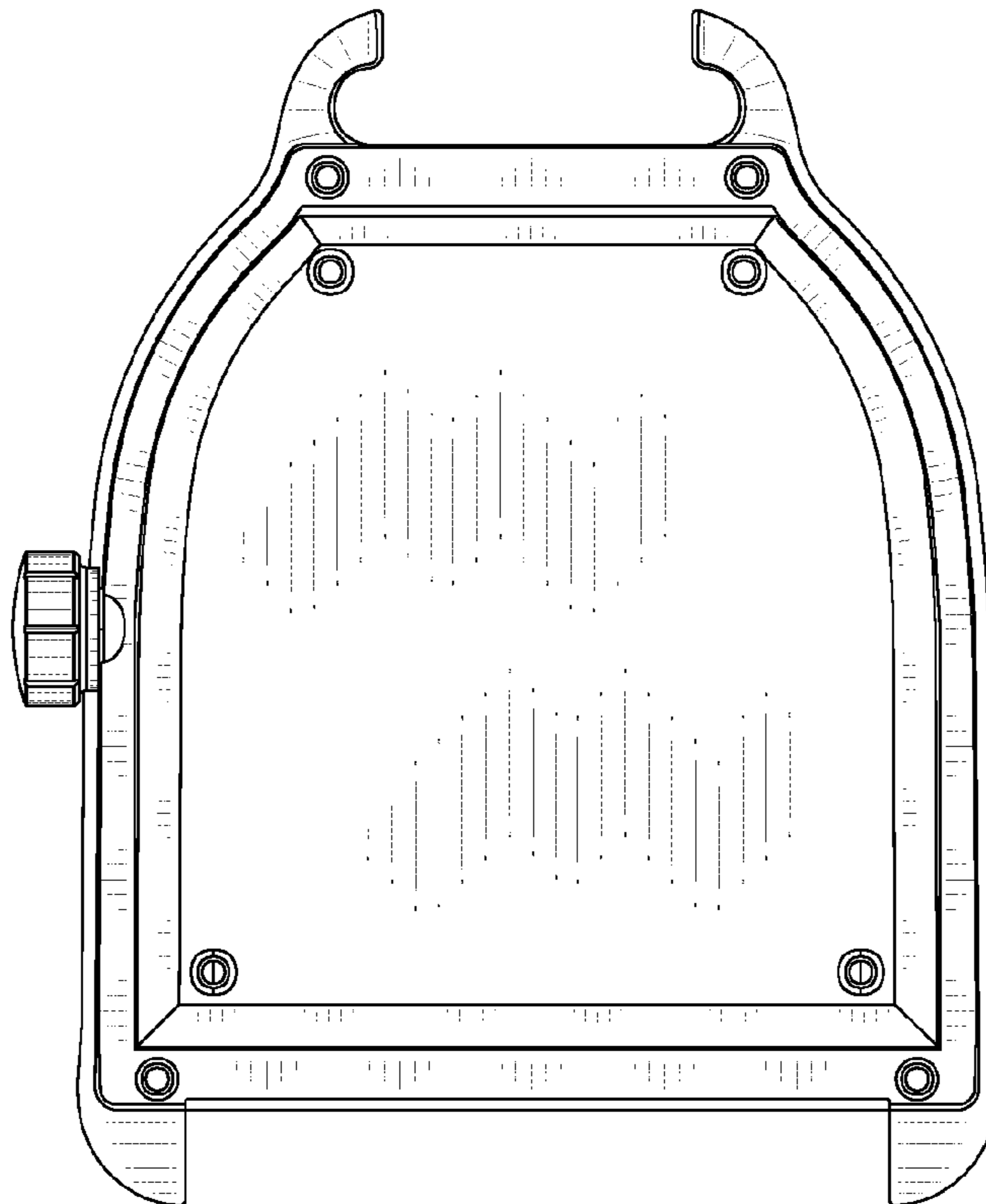

Fig.2

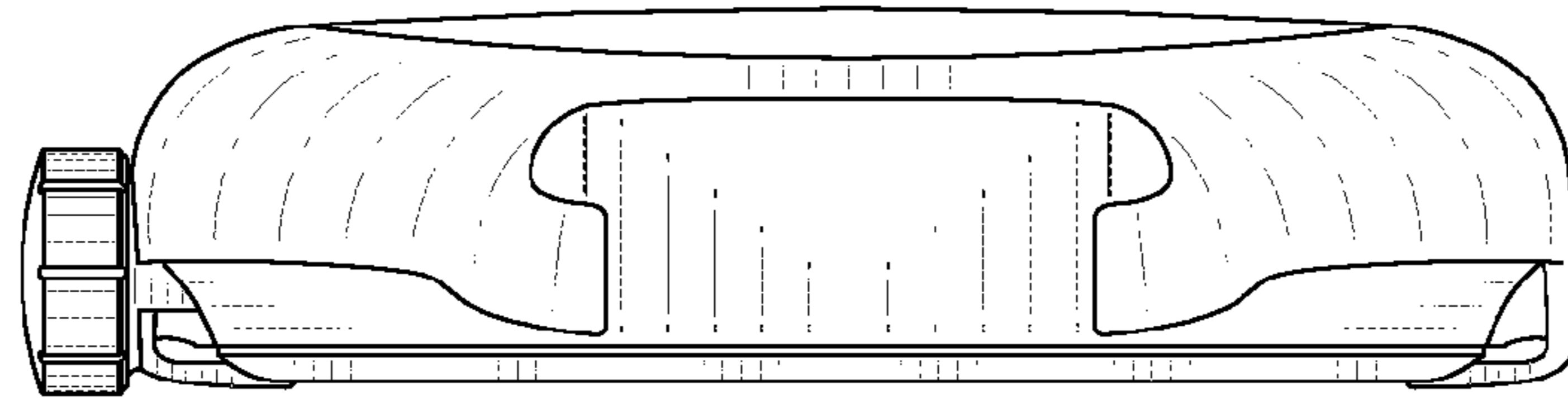

Fig.3

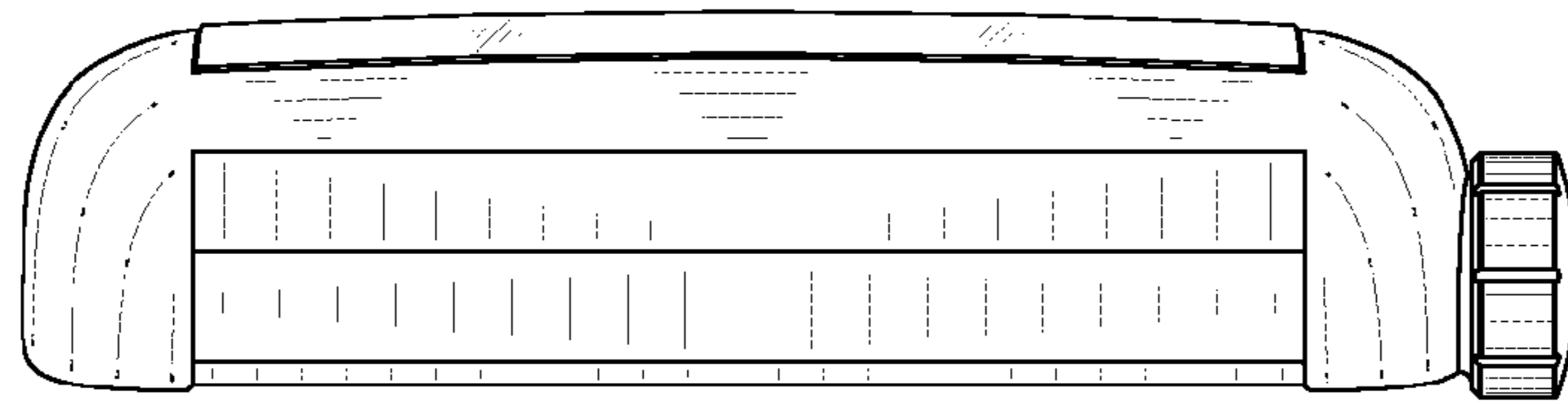

Fig.4

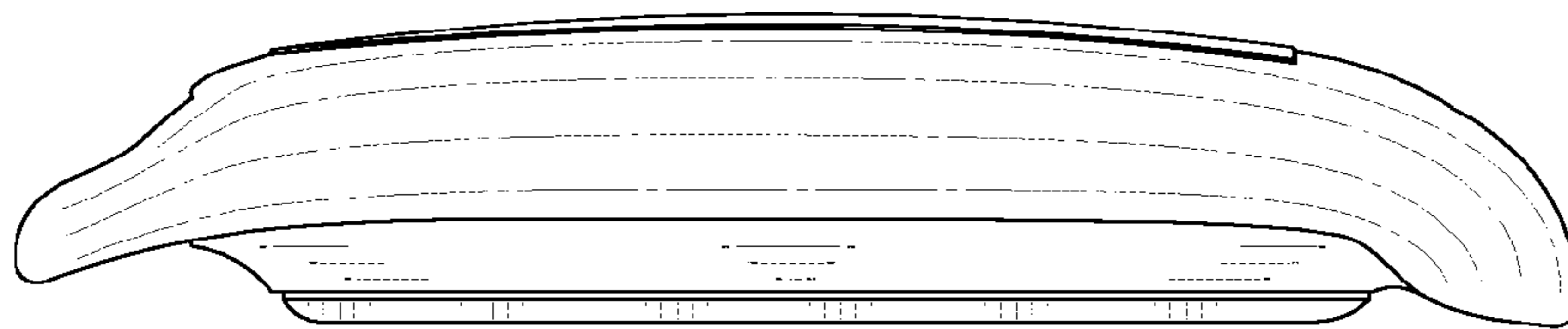

Fig.5

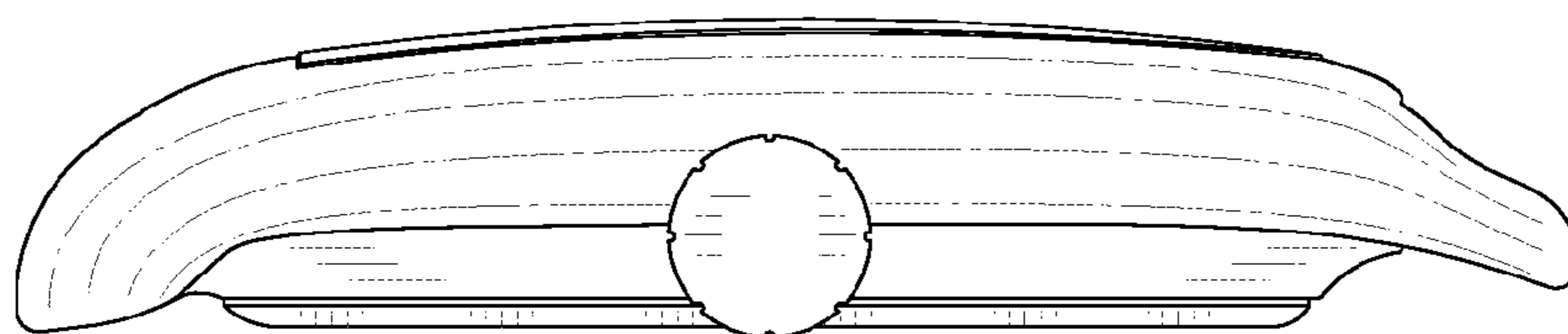

Fig.6

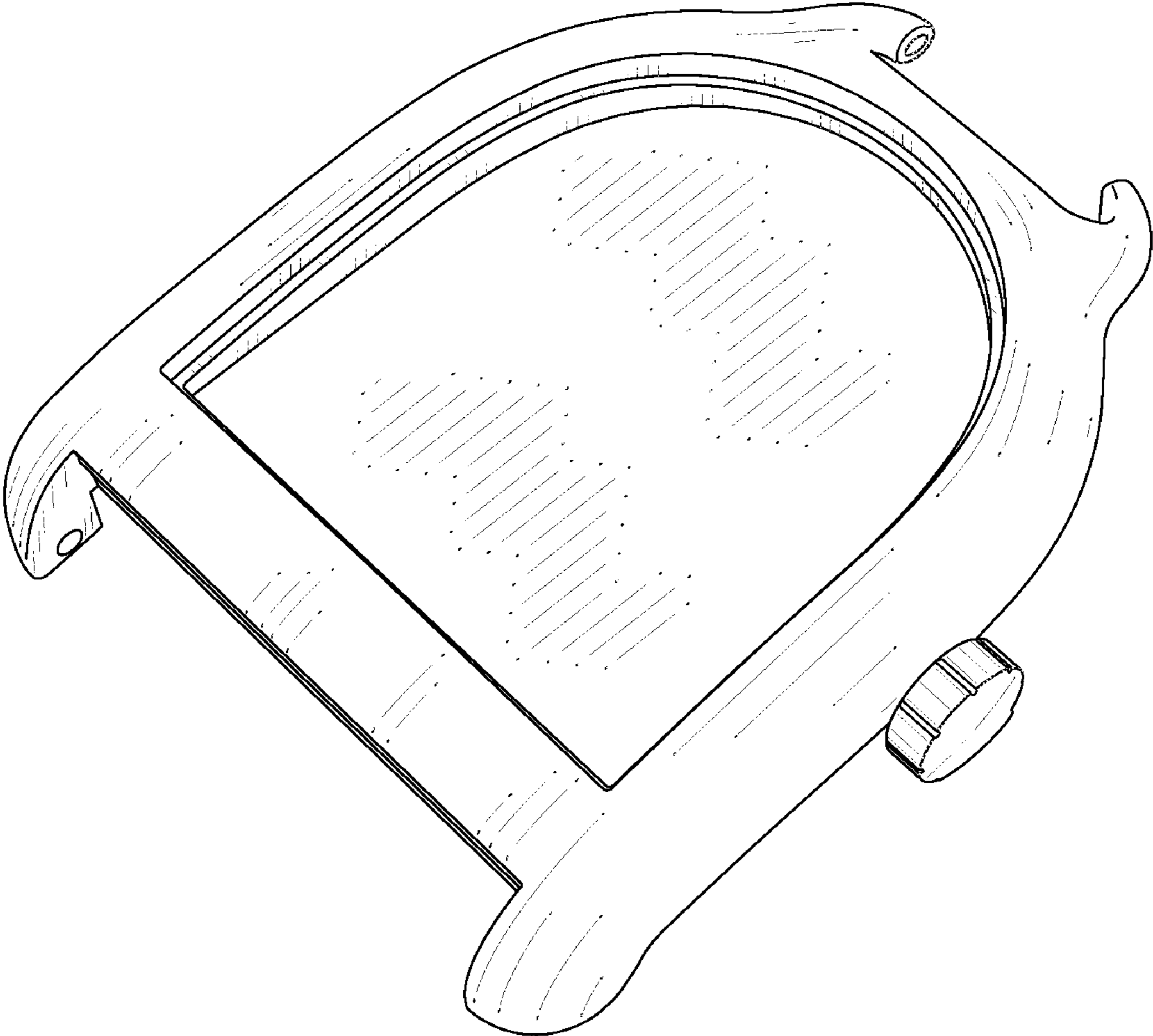

Fig.7