



US00D600998S

(12) **United States Design Patent**  
**De Maria**

(10) **Patent No.:** **US D600,998 S**

(45) **Date of Patent:** **\*\* Sep. 29, 2009**

(54) **LIFTING HANDLE**

(75) Inventor: **Riccardo De Maria**, Sala Bolognese BO (IT)

(73) Assignee: **FAAC S.p.A.**, Zola Predosa BO (IT)

(\*\*) Term: **14 Years**

(21) Appl. No.: **29/300,415**

(22) Filed: **Mar. 25, 2008**

(30) **Foreign Application Priority Data**

Sep. 25, 2007 (IT) ..... MI2007O0195

(51) **LOC (9) Cl.** ..... **08-07**

(52) **U.S. Cl.** ..... **D8/336; D8/343**

(58) **Field of Classification Search** ..... D8/315,  
D8/316, 300, 333, 336, 343, 344; D3/11,  
D3/12, 13, 328; 70/1, 14, 19, 51, 58, 158,  
70/258, 431; 292/246, 256, 256.6, 258, 288;  
296/735, 325, 83, 5, 806; 220/696, 752,  
220/756, 758, 759

See application file for complete search history.

(56) **References Cited**

**U.S. PATENT DOCUMENTS**

4,549,060 A \* 10/1985 Paton et al. .... 219/59.1  
D290,935 S \* 7/1987 Williams ..... D9/434  
D388,326 S \* 12/1997 Gurry et al. .... D9/434  
5,787,140 A \* 7/1998 Dunlap et al. .... 376/313  
5,862,912 A \* 1/1999 Schelhorn ..... 206/321  
D441,653 S \* 5/2001 LeRoux ..... D9/434

6,394,517 B1 \* 5/2002 Borg ..... 294/31.2  
6,968,970 B1 \* 11/2005 Shacklee ..... 220/565  
7,003,917 B2 \* 2/2006 Hetherington et al. .... 52/122.1  
D533,432 S \* 12/2006 Schats et al. .... D8/315  
7,213,371 B1 \* 5/2007 Vanderpan ..... 49/380  
7,373,690 B2 \* 5/2008 Sepke et al. .... 15/410  
7,399,017 B1 \* 7/2008 Lasseigne ..... 294/31.2

\* cited by examiner

*Primary Examiner*—Prabhakar Deshmukh

(74) *Attorney, Agent, or Firm*—Jacobson Holman PLLC

(57) **CLAIM**

I claim the ornamental design for the lifting handle, as shown and described.

**DESCRIPTION**

FIG. 1 is a perspective view of a lifting handle showing my new design;

FIG. 2 is a front elevational view thereof;

FIG. 3 is a rear elevational view thereof;

FIG. 4 is a right-side elevational view thereof;

FIG. 5 is a left-side elevational view thereof;

FIG. 6 is a top plan view thereof;

FIG. 7 is a bottom plan view thereof; and,

FIG. 8 is a perspective view thereof, with the lifting handle shown in its environmental use.

The broken lines environment, showing the lifting handle for actuators for gates and doors, are for illustrative purpose only, and form no part of the claimed design.

**1 Claim, 2 Drawing Sheets**

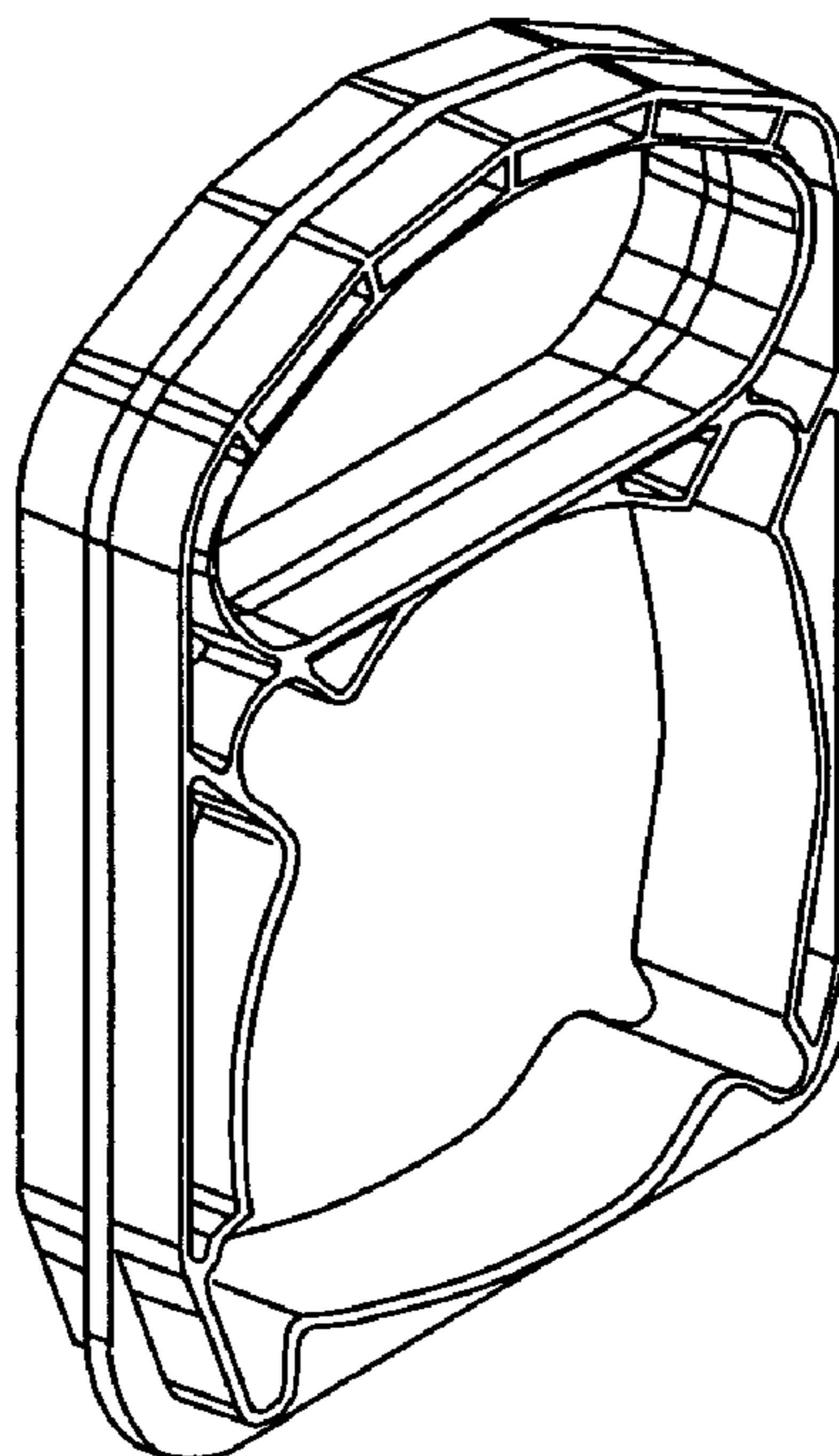

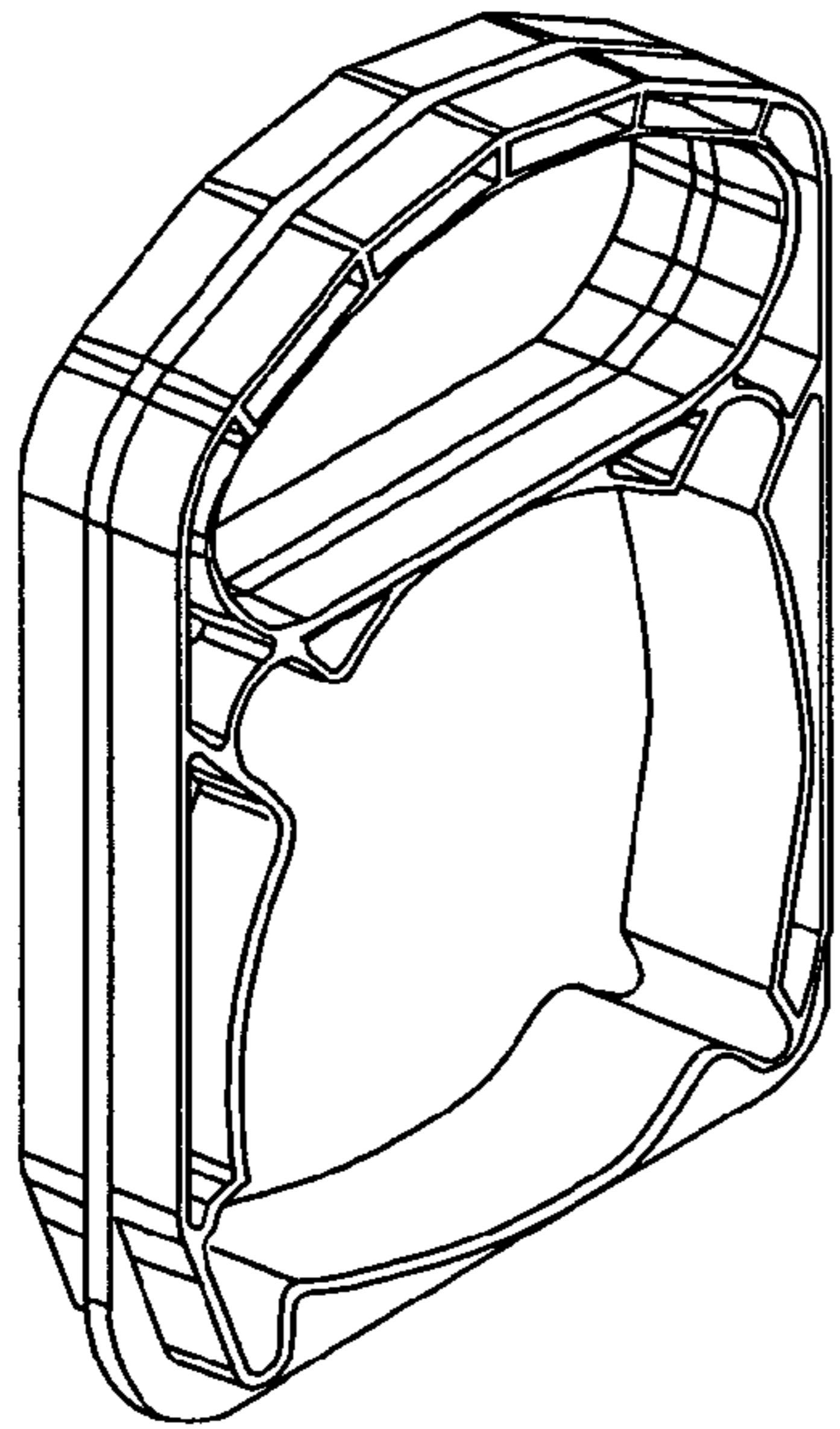

*Fig. 1*

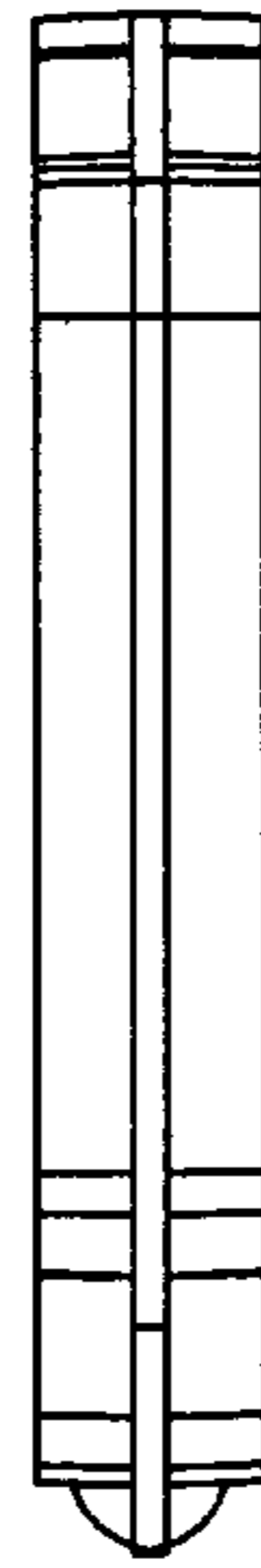

*Fig. 2*



*Fig. 3*

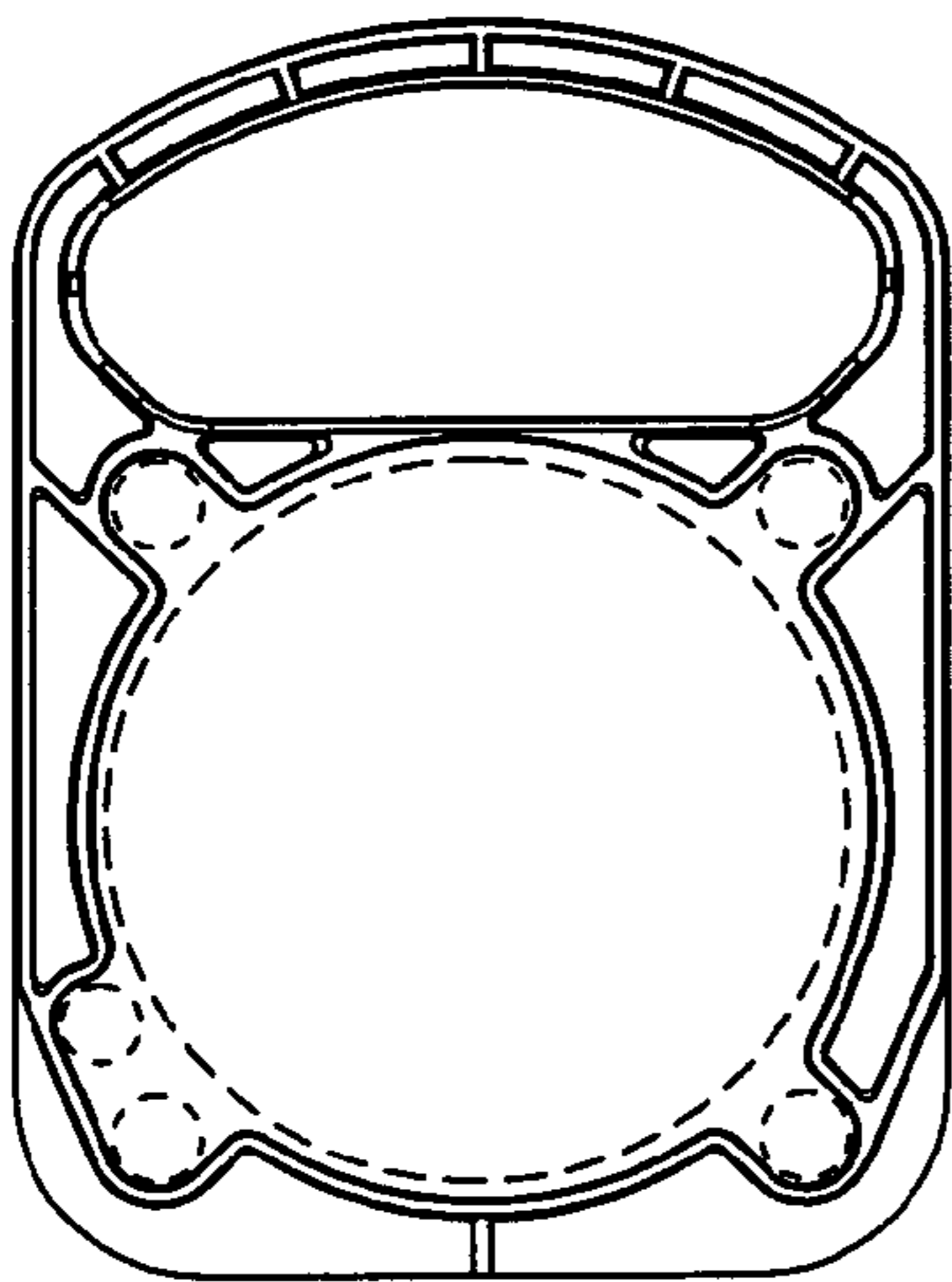

*Fig. 4*

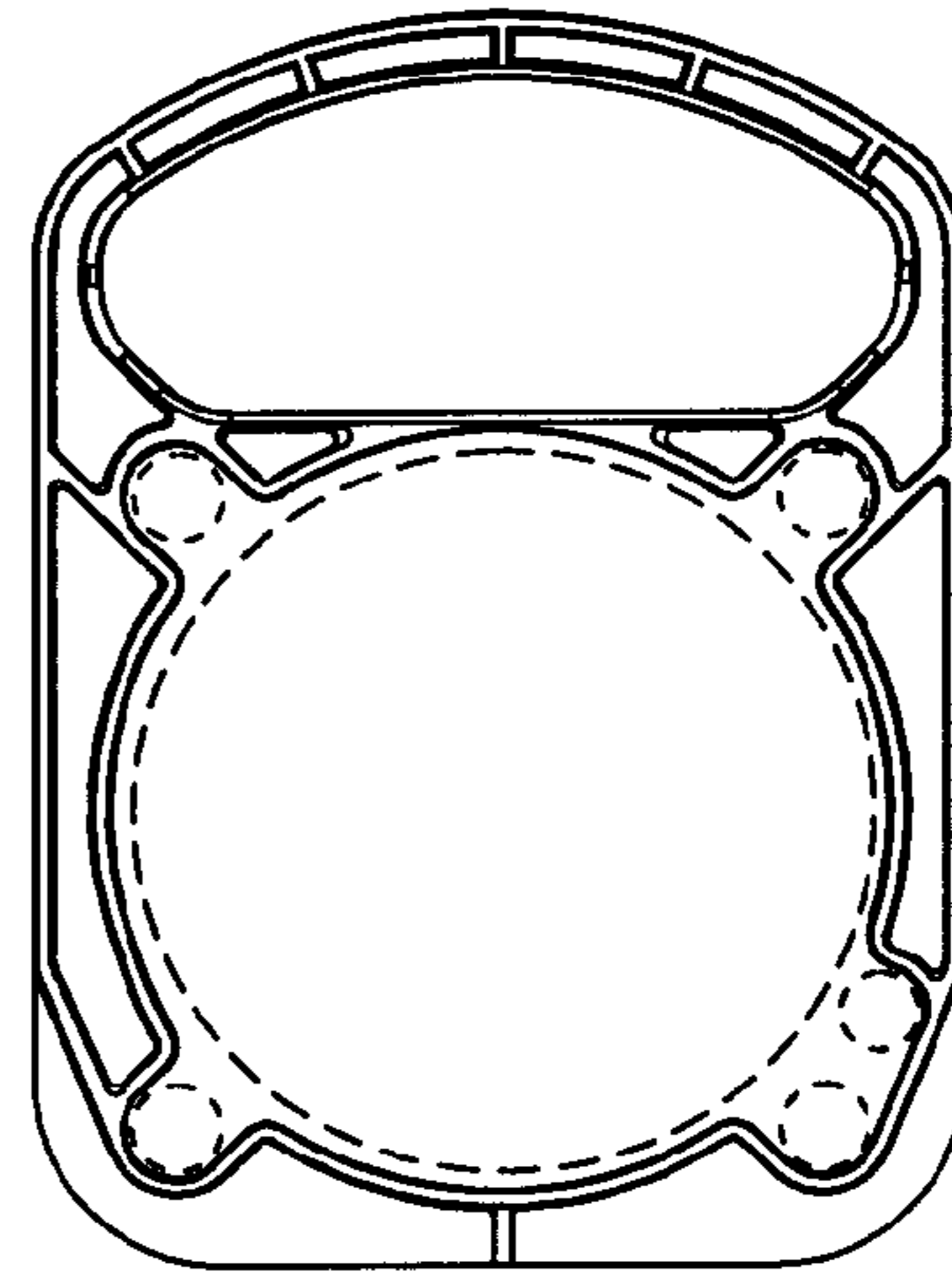

*Fig. 5*



*Fig. 6*

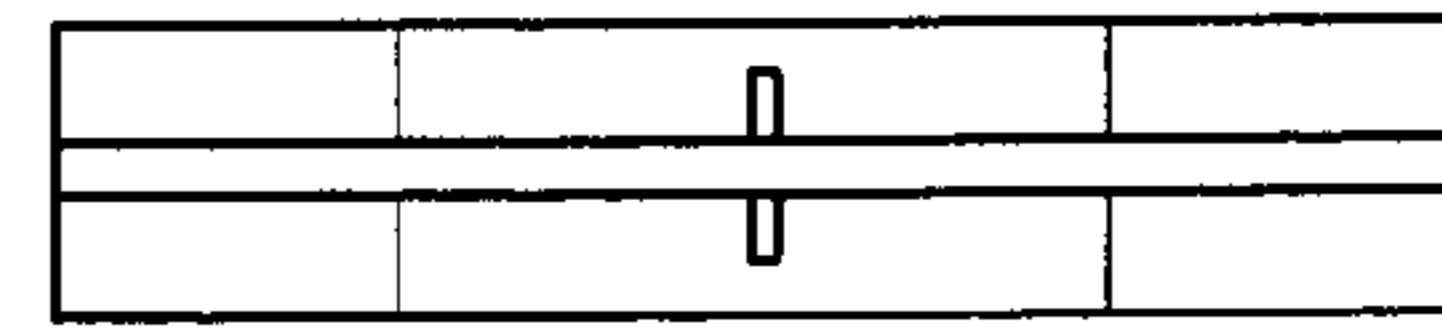

*Fig. 7*

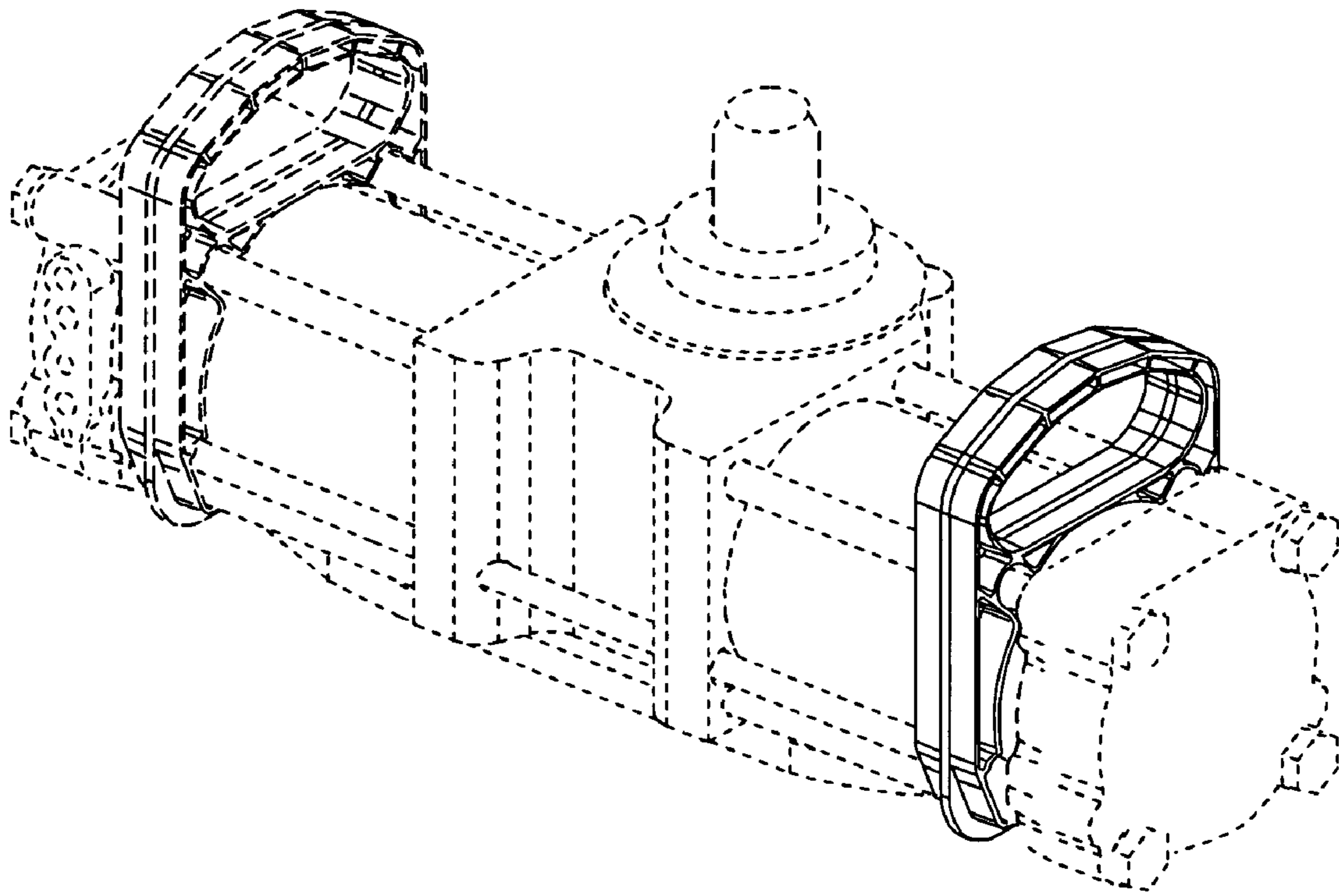

*Fig. 8*