



US00D600890S

(12) **United States Design Patent**
Groves

(10) **Patent No.:** **US D600,890 S**

(45) **Date of Patent:** **** Sep. 29, 2009**

(54) **POCKET SQUARE HOLDER**

(76) Inventor: **Greg W. Groves**, 12029 Ashford Dr.,
Yukon, OK (US) 73099

(**) Term: **14 Years**

(21) Appl. No.: **29/308,822**

(22) Filed: **Jul. 10, 2008**

Related U.S. Application Data

(63) Continuation of application No. 11/286,674, filed on
Nov. 23, 2005, now abandoned.

(51) **LOC (9) Cl.** **02-02**

(52) **U.S. Cl.** **D2/860**

(58) **Field of Classification Search** D2/853,
D2/857, 860, 864; 2/455, 46, 247, 250
See application file for complete search history.

(56) **References Cited**

U.S. PATENT DOCUMENTS

1,380,212	A *	5/1921	Jurgielewicz	2/252
1,875,847	A *	9/1932	Bruce	2/254
2,269,511	A	1/1942	Biederman	
2,738,515	A	3/1956	Owen	
2,746,058	A *	5/1956	Greer	2/249
2,803,831	A *	8/1957	Creighton	2/279
2,823,720	A *	2/1958	Svec et al.	383/65
3,216,135	A *	11/1965	Wright	40/1.5
3,412,435	A	11/1968	Poppe	
3,492,677	A	2/1970	Bertelink	
3,647,056	A *	3/1972	Jacobson et al.	206/5
3,786,520	A *	1/1974	Harmon	2/279
4,509,277	A *	4/1985	Bolton	40/1.5
D375,611	S *	11/1996	Cannon	D2/857
D492,469	S *	7/2004	Broxholm	D2/857

7,107,627 B2 * 9/2006 Holland 2/247

* cited by examiner

Primary Examiner—Charles A Rademaker

Assistant Examiner—R. Johnson

(74) *Attorney, Agent, or Firm*—Dunlap Coddling, P.C.

(57) **CLAIM**

The ornamental design for a pocket square holder, as shown and described.

DESCRIPTION

FIG. 1 is a front view of the pocket square holder showing my new design, a handkerchief being supported thereon and shown in phantom for illustrative purposes only and forming no part of the claim design;

FIG. 2 is a rear view thereof;

FIG. 3 is an elevational view of a one-side thereof;

FIG. 4 is an elevational view of a side thereof opposite the side shown in FIG. 3;

FIG. 5 is a top plan view thereof;

FIG. 6 is a bottom plan view thereof;

FIG. 7 is a front view of another embodiment of the pocket square holder showing my new design;

FIG. 8 is a rear view thereof;

FIG. 9 is an elevational view of one side thereof;

FIG. 10 is an elevational view of the side opposite the side shown in FIG. 9;

FIG. 11 is a bottom plan view thereof; and,

FIG. 12 is a top plan view thereof.

The broken lines shown throughout the views, on the surface of the pocket square holder represent stitching.

1 Claim, 4 Drawing Sheets

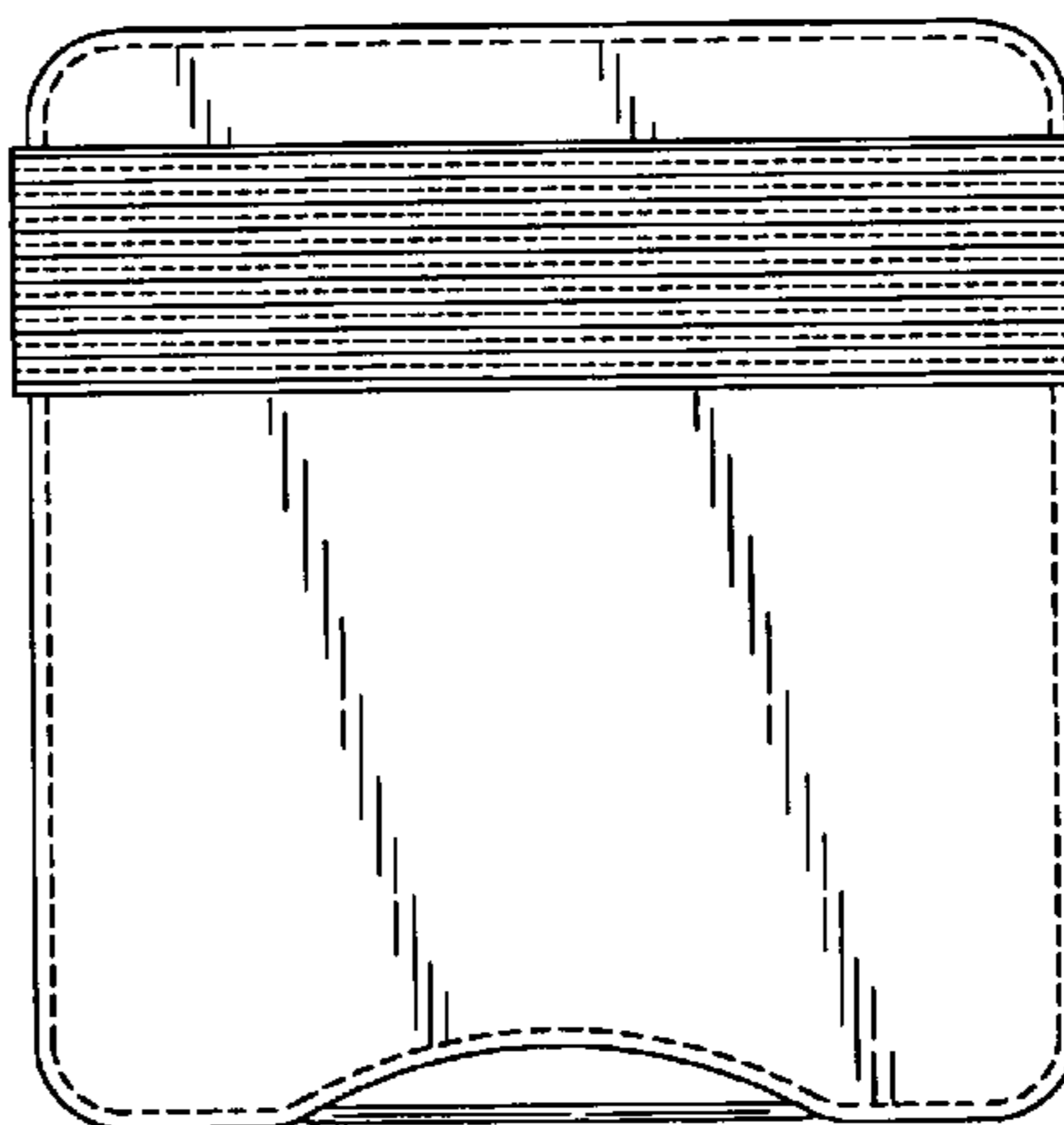
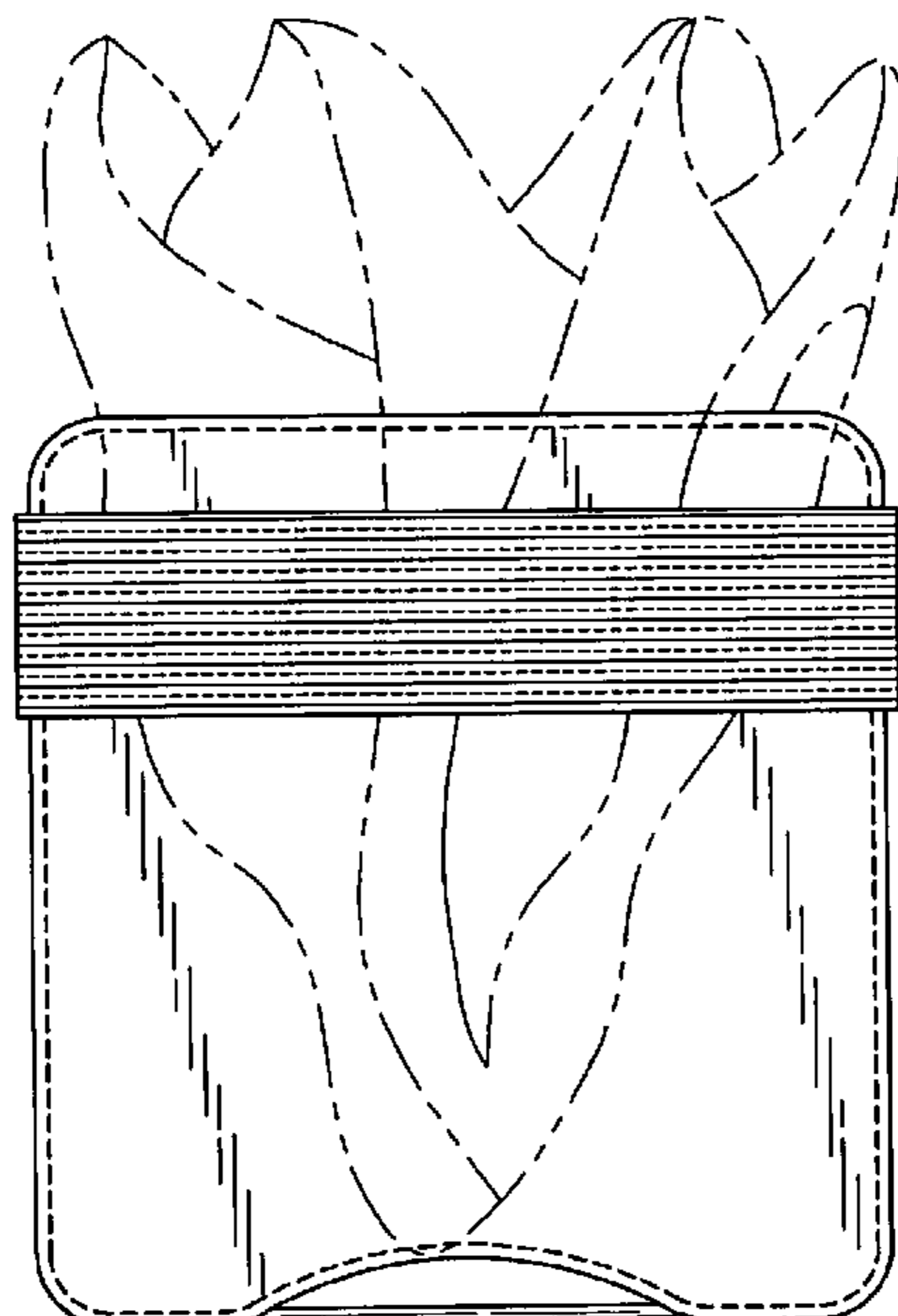

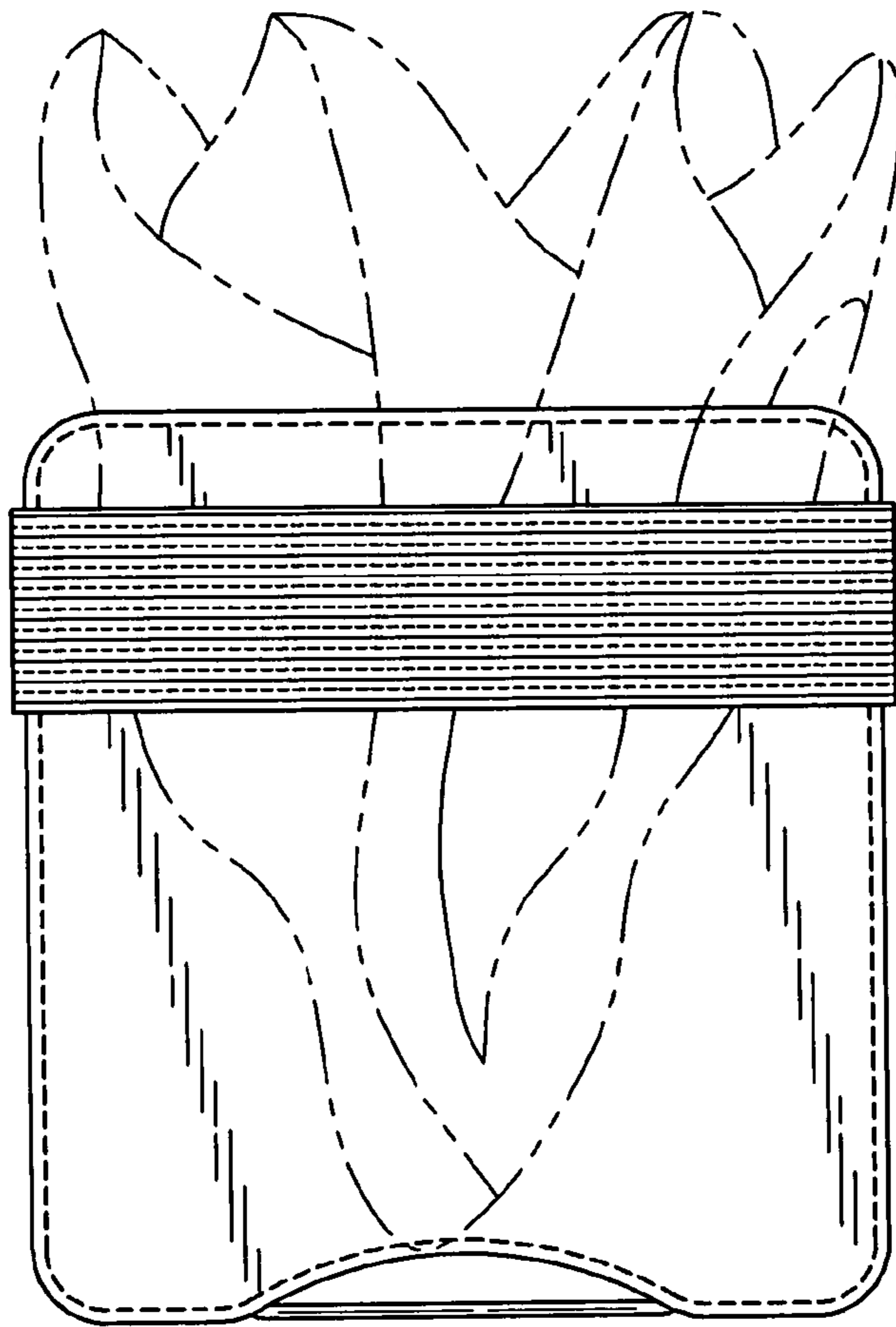

FIG. 1

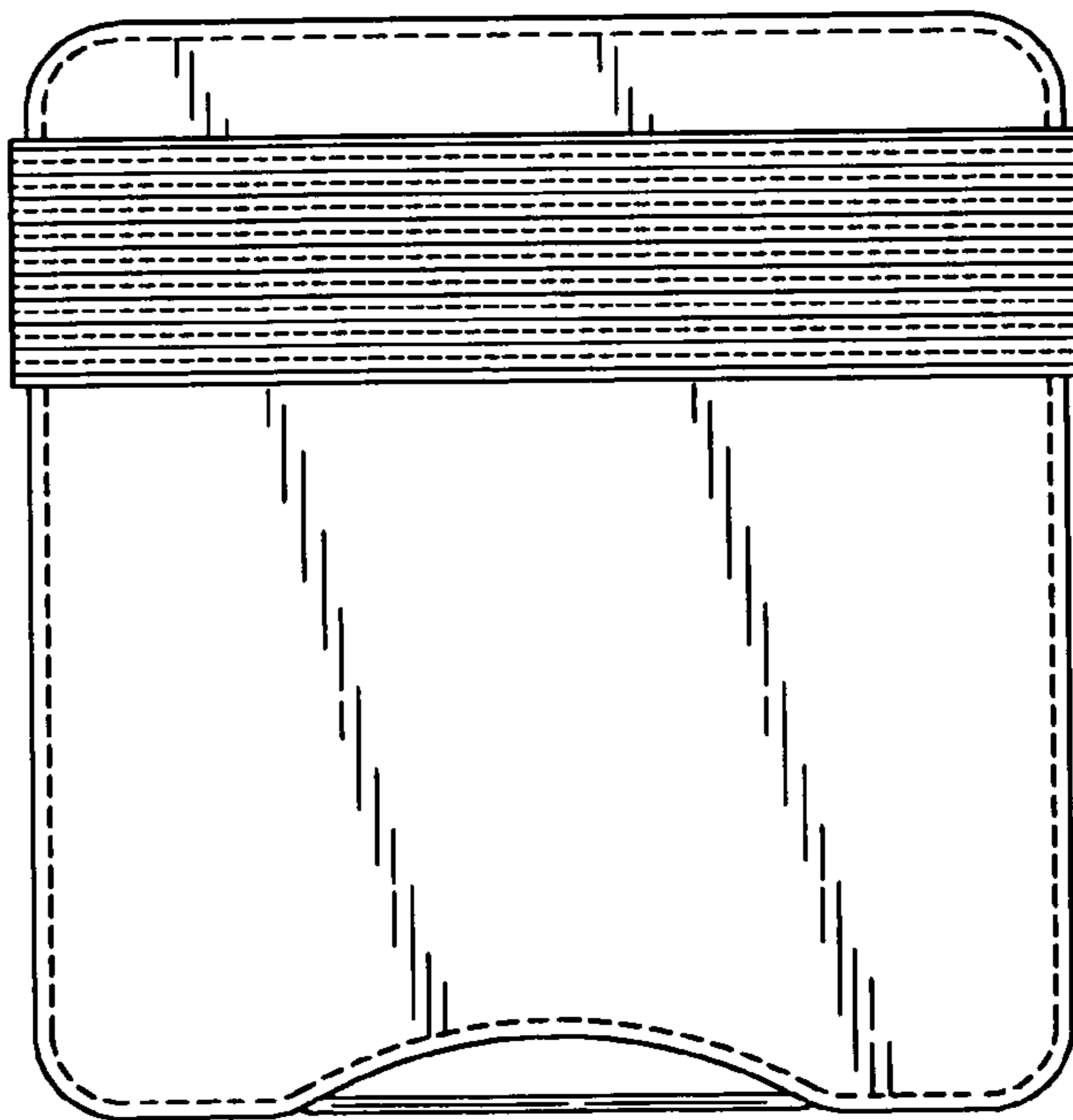
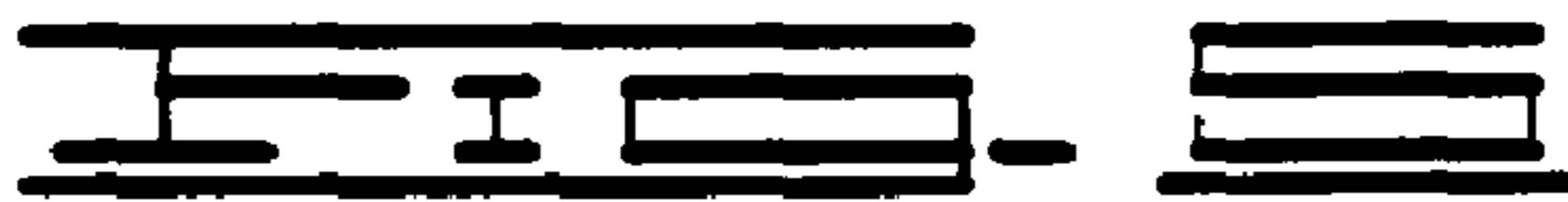
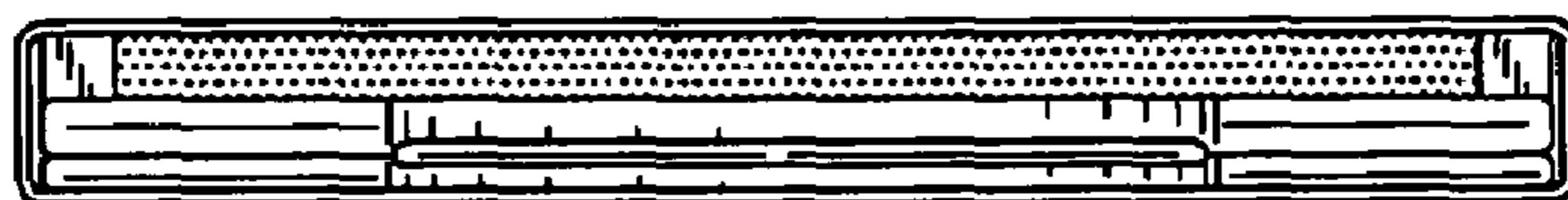
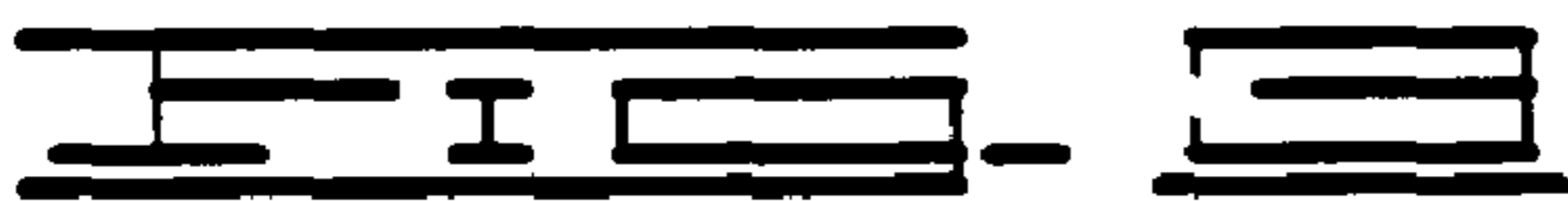
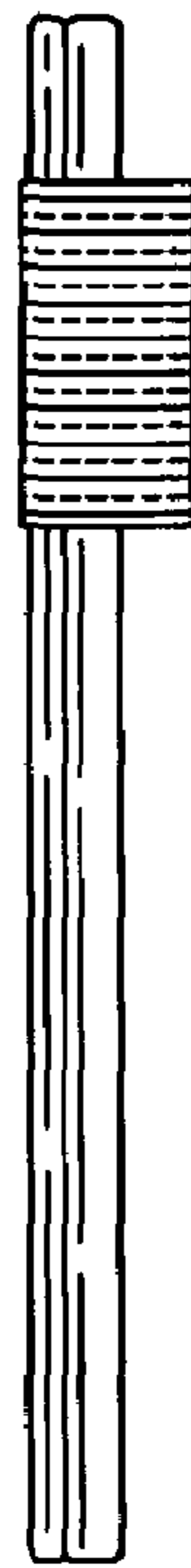

FIG. 2



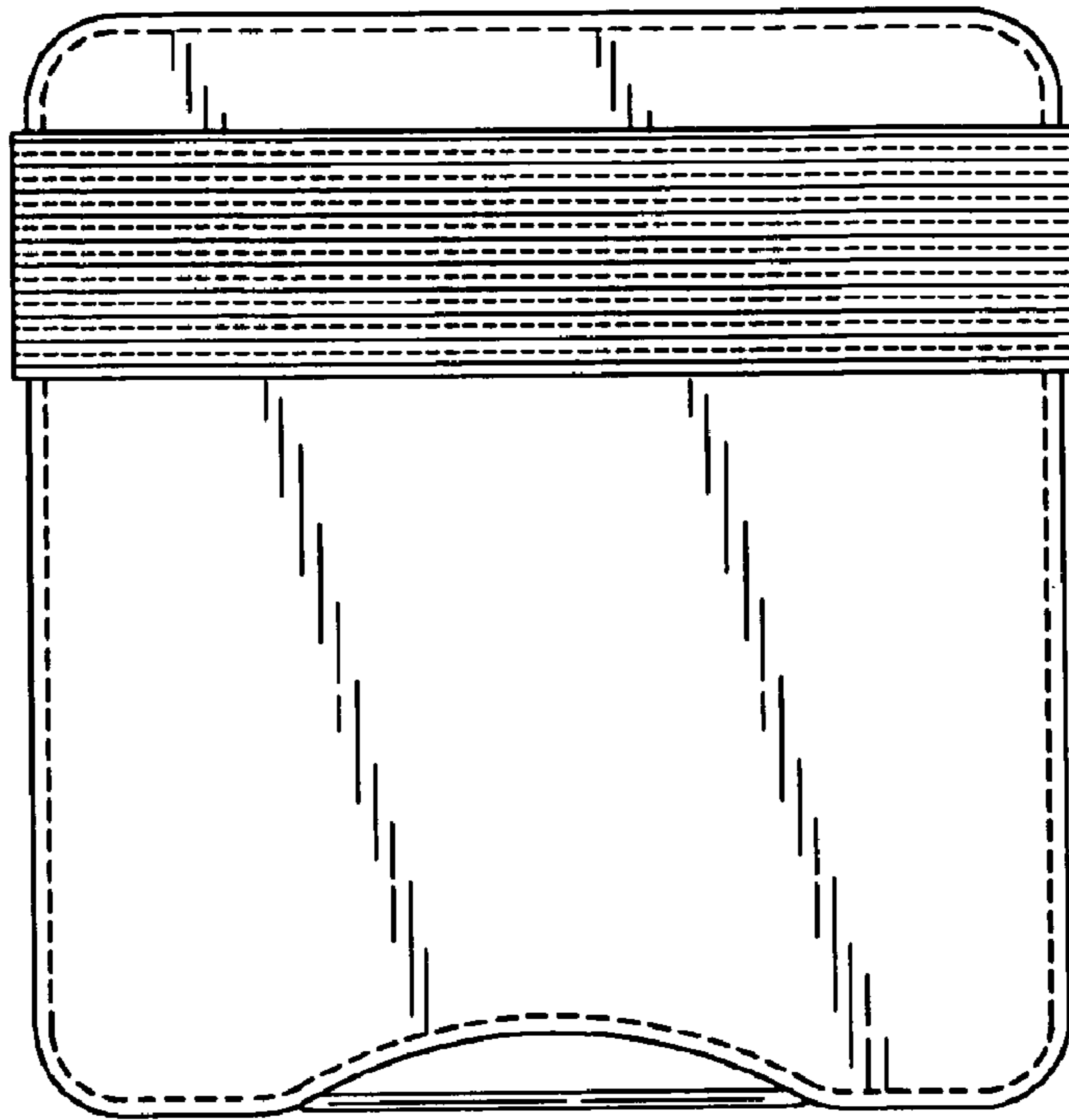

FIG. 2

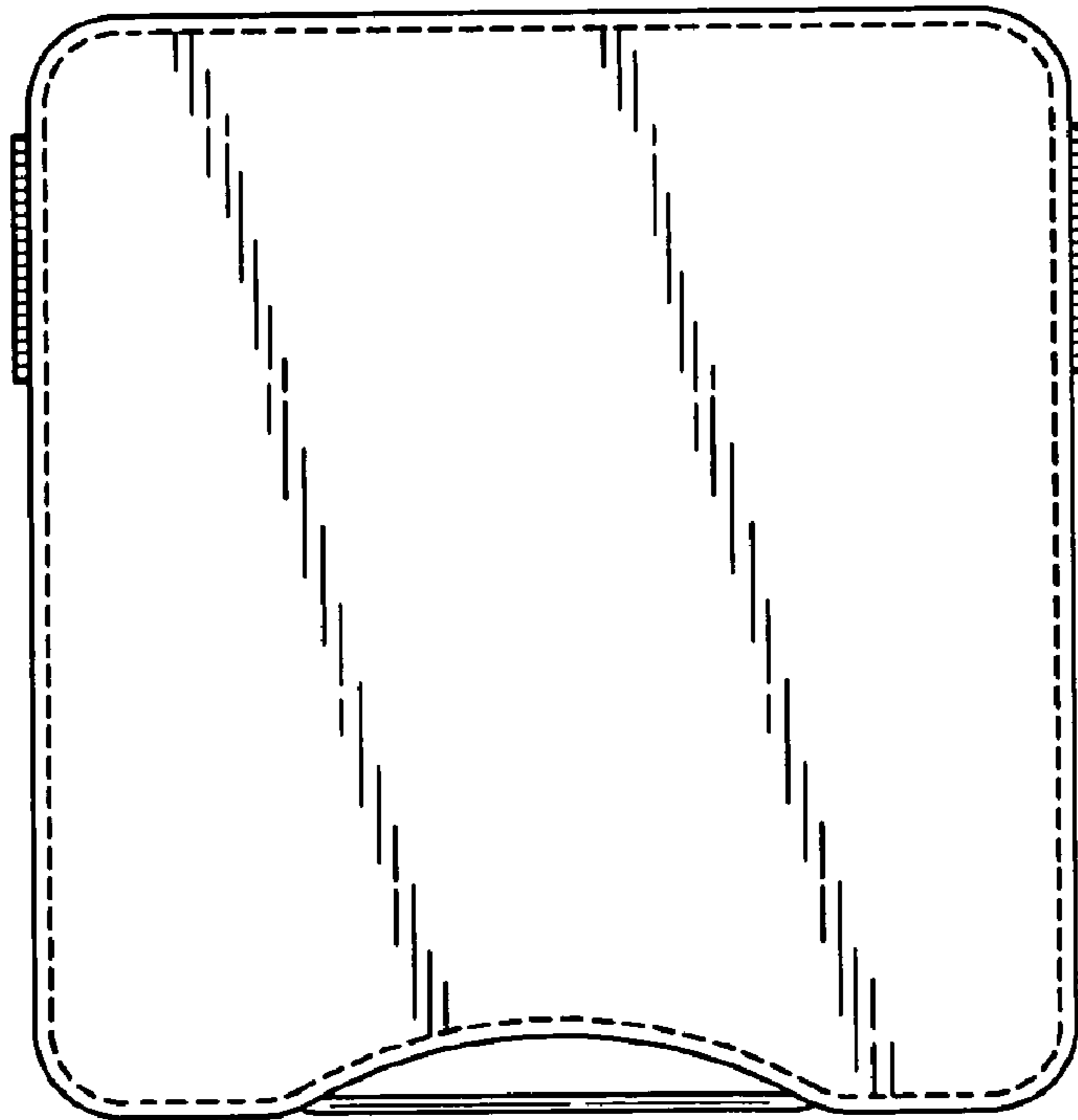

FIG. 3

