



US00D600806S

(12) **United States Design Patent**
Horton et al.

(10) **Patent No.:** **US D600,806 S**

(45) **Date of Patent:** **** Sep. 22, 2009**

(54) **CANNULATED SURGICAL INSTRUMENT**

(76) Inventors: **Kenneth L. Horton**, 327 Shades Crest Rd., Birmingham, AL (US) 35226;
Joshua J. Reardon, 6349 Woodmere Dr., Tuscaloosa, AL (US) 35405

(**) Term: **14 Years**

(21) Appl. No.: **29/329,294**

(22) Filed: **Dec. 11, 2008**

(51) **LOC (9) Cl.** **24-02**

(52) **U.S. Cl.** **D24/133**

(58) **Field of Classification Search** D24/133,
D24/146, 147; 606/167, 170; 600/562, 564-567
See application file for complete search history.

(56) **References Cited**

U.S. PATENT DOCUMENTS

4,581,962	A	4/1986	Marbourg	
5,015,247	A	5/1991	Michelson	
5,231,989	A *	8/1993	Middleman et al.	600/434
5,484,437	A	1/1996	Michelson	
5,593,409	A	1/1997	Michelson	
5,741,253	A	4/1998	Michelson	
6,080,155	A	6/2000	Michelson	
D439,980	S *	4/2001	Reiley et al.	D24/147
D449,691	S *	10/2001	Reiley et al.	D24/147
6,902,578	B1	6/2005	Anderson et al.	
6,923,810	B1	8/2005	Michelson	
D512,506	S *	12/2005	Layne et al.	D24/147
7,081,122	B1 *	7/2006	Reiley et al.	606/185
7,223,269	B2	5/2007	Chappuis	
7,399,306	B2 *	7/2008	Reiley et al.	606/185
D574,495	S	8/2008	Petersen	
D574,957	S	8/2008	Petersen	
D581,538	S	11/2008	Horton	

2004/0215344	A1	10/2004	Hochschuler et al.
2005/0015150	A1	1/2005	Lee
2006/0036264	A1	2/2006	Selover et al.
2006/0111779	A1	5/2006	Petersen
2006/0111782	A1	5/2006	Petersen
2007/0250166	A1	10/2007	McKay
2008/0255667	A1	10/2008	Horton

OTHER PUBLICATIONS

Stein, M. et al, Percutaneous Facet Joint Fusion: Preliminary Experience, J. Vasc. Interv. Radiol., Jan.-Feb. 1994, 4 (1) 69-74.

* cited by examiner

Primary Examiner—Lisa P Lichtenstein

(74) *Attorney, Agent, or Firm*—Kenneth M. Bush; Bush Intellectual Property Law

(57) **CLAIM**

We claim the ornamental design for a cannulated surgical instrument, as shown and described.

DESCRIPTION

The ornamental design for a cannulated surgical instrument for locating a facet joint.

FIG. 1 is a bottom perspective view of a cannulated surgical instrument showing our new design;

FIG. 2 is a top perspective view thereof;

FIG. 3 is a front elevational view thereof;

FIG. 4 is a rear elevational view thereof;

FIG. 5 is a right side elevational view thereof;

FIG. 6 is a left side elevational view thereof;

FIG. 7 is an enlarged bottom plan view thereof; and,

FIG. 8 is an enlarged top plan view thereof.

1 Claim, 2 Drawing Sheets

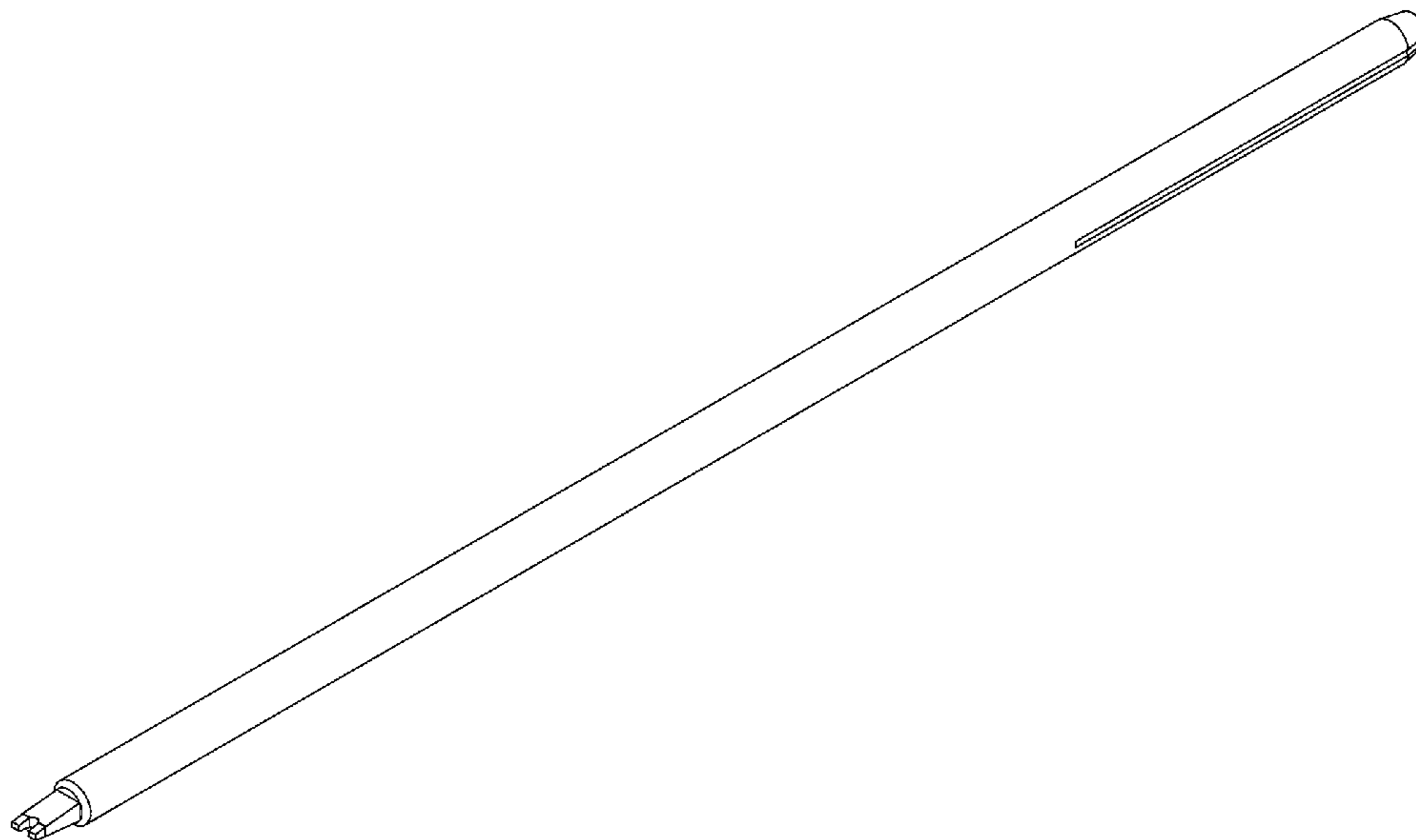

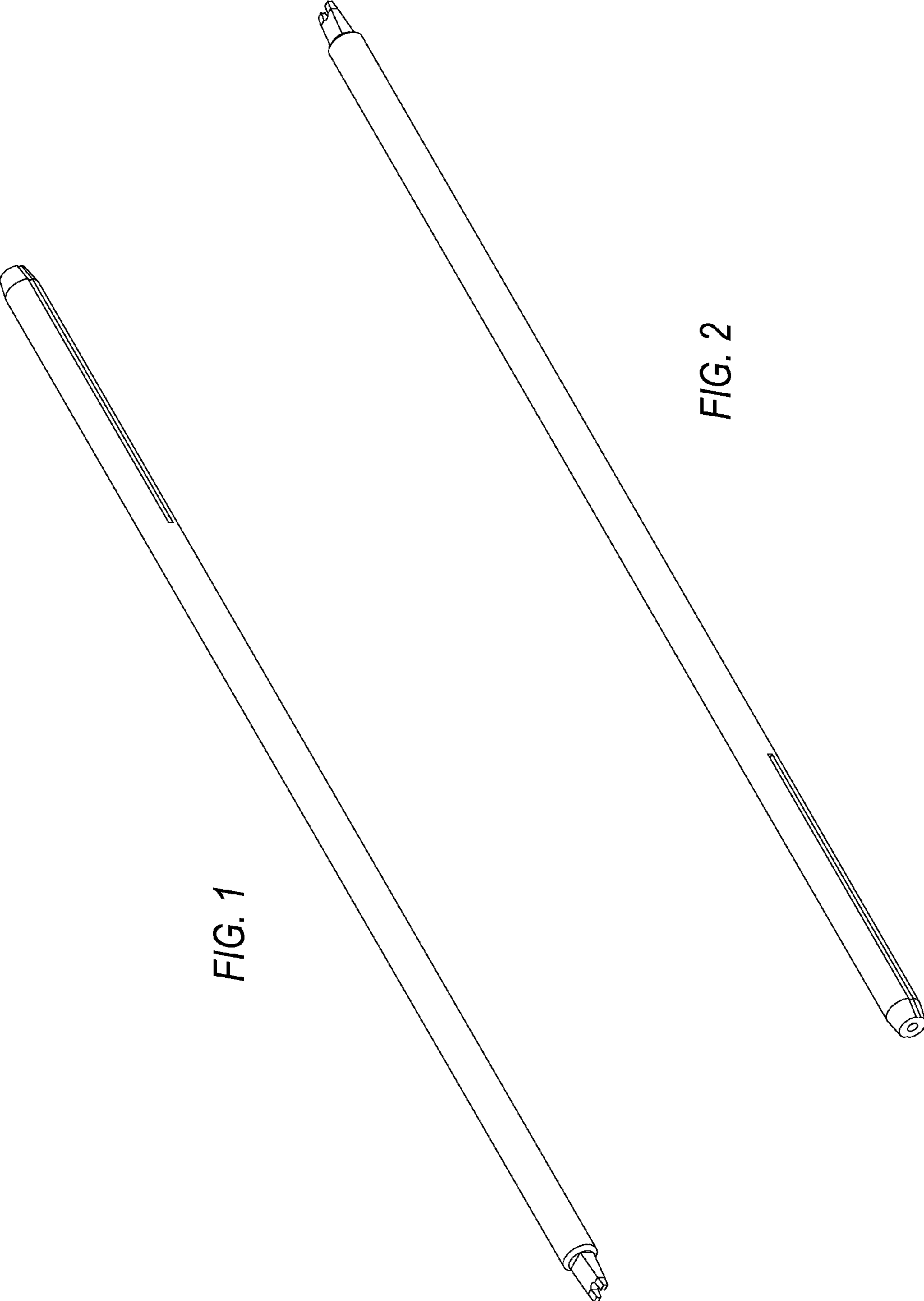

FIG. 1

FIG. 2

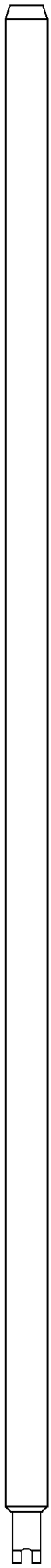

FIG. 3

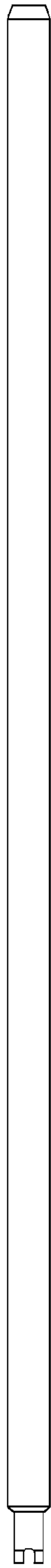

FIG. 4



FIG. 5

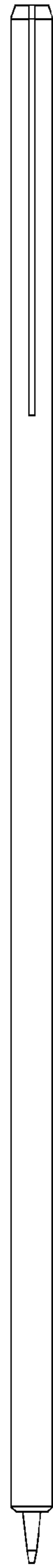

FIG. 6

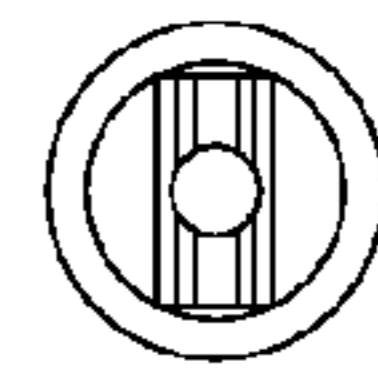

FIG. 7

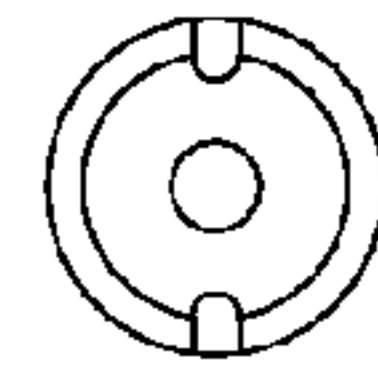

FIG. 8